

# *Lang*



## **Service Manual for the Lang Models:**

**0-2-10-3, 0-2-10-4, 0-2-10-5**

# TABLE OF CONTENTS

<b><u>CHAPTER</u></b>	<b><u>PAGE</u></b>
1. TABLE OF CONTENTS.....	1
2. READ FIRST .....	2
3. EQUIPMENT DESCRIPTION.....	4
4. INSTALLATION .....	5
5. START-UP.....	7
6. GENERAL OPERATION .....	8
7. SEQUENCE OF OPERATION.....	10
8. TROUBLESHOOTING.....	11
9. TECHNICAL DATA.....	13
10. WIRING DIAGRAM.....	14
11. PARTS LIST .....	15

**IMPORTANT****READ FIRST****IMPORTANT**

**CAUTION:** EACH IS HEAVY. FOR SAFE HANDLING, INSTALLER SHOULD OBTAIN HELP AS NEEDED, OR EMPLOY APPROPREATE MATERIALS HANDLING EQUIPMENT (SUCH AS A FORKLIFT, DOLLY, OR PALLET JACK) TO REMOVE THE UNIT FROM THE SKID AND MOVE IT TO THE PLACE OF INSTALLATION.



**CAUTION:** ANY STAND, COUNTER OR OTHER DEVICE ON WHICH OVEN WILL BE LOCATED MUST BE DESIGNED TO SUPPORT THE WEIGHT OF THE OVEN.



**CAUTION:** SHIPPING STRAPS ARE UNDER TENSION AND CAN SNAP BACK WHEN CUT.



**DANGER:** THIS APPLIANCE MUST BE GROUNDED AT THE TERMINAL PROVIDED. FAILURE TO GROUND THE APPLIANCE COULD RELUT IN ELECTOCUTION AND DEATH.



**WARNING:** INSTALLATION OF THE UNIT MUST BE DONE BY PERSONNEL QUALIFIED TO WORK WITH ELECTRICITY AND PLUMBING. IMPROPER INSTALLATION CAN CAUSE INJURY TO PERSONNEL AND/OR DAMAGE TO EQUIPMENT. UNIT MUST BE INSTALLED IN ACCORDANCE WITH ALL APPLICABLE CODES



**WARNING:** BEFORE LIGHTING, USE A SOAP AND WATER SOUTION TO TEST ALL JOINTS FOR GAS LEAKS.

**WARNING:** DURING INITIAL USE, OR AFTER SERVICE, IF PILOT DOES NOT IGNITE ON FIRST TRY THE MAIN GAS VALVE MUST BE TURNED OFF FOR AT LEAST FIVE MINUTES.



**NOTICE:** The data plate is located left side of unit behind control door. The melter voltage, gas specs, serial number, pipe size, and clearance specifications are on the data plate. This information should be carefully read and understood before proceeding with the installation.



**NOTICE:** The installation of any components such as a vent hood, grease extractors, fire extinguisher systems, must conform to their applicable National, State and locally recognized installation standards.



**NOTICE:** During the first few hours of operation you may notice a small amount of smoke coming off the oven, and a faint odor from the smoke. This is normal for a new oven and will disapper after the first few hours of use.



**WARNING:** KEEP WATER AND SOLUTIONS OUT OF CONTROLS. NEVER SPRAY OR HOSE CONTROL CONSOLE, ELECTRICAL CONNECTIONS, ETC.



**CAUTION:** ALWAYS KEEP THE AREA NEAR THE APPLIANCE FREE FROM COMBUSTIBLE MATERIALS.

**CAUTION:** KEEP FLOOR IN FRONT OF EQUIPMENT CLEAN AND DRY. IF SPILLS OCCUR, CLEAN IMMEDIATELY, TO AVOID THE DANGER OF SLIPS OR FALLS.



**CAUTION:** MOST CLEANERS ARE HARMFUL TO THE SKIN, EYES, MUCOUS MEMBRANES AND CLOTHING. PRECAUTIONS SHOULD BE TAKEN TO WEAR RUBBER GLOVES, GOGGLES OR FACE SHIELD AND PROTECTIVE CLOTHING. CAREFULLY READ THE WARNING AND FOLLOW THE DIRECTIONS ON THE LABEL OF THE CLEANER TO BE USED.



**NOTICE:** Service on this, or any other, LANG appliance must be performed by qualified personnel only. Consult your authorized service station directory or call the factory at 1-800-224-LANG (5264), or WWW.LANGWORLD.COM for the service station nearest you.



**WARNING:** BOTH HIGH AND LOW VOLTAGES ARE PRESENT INSIDE THIS APPLIANCE WHEN THE UNIT IS PLUGGED/WIRED INTO A LIVE RECEPTACLE. BEFORE REPLACING ANY PARTS, DISCONNECT THE UNIT FROM THE ELECTRIC POWER SUPPLY.



**CAUTION:** USE OF ANY REPLACEMENT PARTS OTHER THAN THOSE SUPPLIED BY LANG OR THEIR AUTHORIZED DISTRIBUTORS CAN CAUSE BODILY INJURY TO THE OPERATOR AND DAMAGE TO THE EQUIPMENT AND WILL VOID ALL WARRANTIES.



## EQUIPMENT DESCRIPTION

### GAS MELTER

#### EXTERIOR

- The melter dimensions are 28" (71cm) High, 21" (53cm) Deep, 36", 48", 60" (91cm, 122cm, 152cm) wide dependent on the actual model number.
- The Sides, Bottom, and Rear wall are constructed stainless steel.
- The melter cavity is insulated with high temperature insulation for efficiency and reduced heat loss.

#### INTERIOR

- The interior of the melter has one rack that can be placed in 4 different positions.
- The interior of the melter has a rack sensitive micro-switch for quick and easy activation.

### CONTROLS

#### ◆ AUTOMATIC

- Main burner will only come on when the rack sensitive micro-switch is activated. If there is nothing on the rack the melter is in a standby mode with only the pilot light on.

#### ◆ CONTINUOUS

- Main burner is on all the time.

## **RECEIVING THE MELTER**

Upon receipt, check for freight damage, both visible and concealed. Visible damage should be noted on the freight bill at the time of delivery and signed by the carrier's agent. Concealed loss or damage means loss or damage, which does not become apparent until the merchandise has been unpacked.

If concealed loss or damage is discovered upon unpacking, make a written request for inspection by the carrier's agent within 15 days of delivery. All packing material should be kept for inspection.

Do not return damaged merchandise to Lang Manufacturing Company. File your claim with the carrier.

Prior to un-crating, move the melter as near its intended location as practical. The crating will help protect the unit from the physical damage normally associated with moving it through hallways and doorways.

## **ELECTRICAL CONNECTION**

The electrical connection must be made in accordance with local codes or in the absence of local codes with NFPA No. 70 latest edition (in Canada use: CAS STD. C22.1).

Each appliance requires a 115 volt grounded supply at 1 amp.

Supply wire size must be large enough to carry the amperage load for the number of appliances being installed. Wire size information can be found on the data plate.

## **GAS CONNECTION**

This appliance must be installed under a ventilation hood. The installation of any components such as vent hoods, grease extractors, fire and smoke detection devices, or fire extinguisher systems, must conform to N.F.P.A Standard #96, latest edition.

To prevent the function of this appliance from being affected by a reduced atmospheric pressure, adequate make-up air in the kitchen should be provided to replace the air taken out by the ventilating system.

This appliance is manufactured for use with the type of gas indicated on the data plate. Contact the factory if the gas type does not match that which is on the data plate.

All gas connections must be in accordance with local codes and comply with the National Fuel Gas Code ANSI Z223.1 latest edition.

Gas must be delivered to the appliance regulator at less than 1/2 pound of pressure and less than 1/2 inch water column pressure drop.

The regulator on this appliance is set to 6 inches water column for natural gas and 10 inches water column for propane. A 1/8 inch NPT tap is provided on the main manifold for checking regulator pressure.

When replacing the 1/8 inch plug in the main manifold a joint sealant that is resistant to the action of liquid petroleum gas must be used.

The supply piping must be of sufficient size to provide 10,000 BTU/hr per foot of Cheese Melter. A 1/2 inch NPT connection is provided at the lower right rear corner.

A gas shut off valve must be installed to the appliance and located in an accessible area.

This appliance and its individual shutoff valve must be disconnected from the gas supply piping system during any pressure testing of that system at test pressures in excess of 1/2 PSIG (3.45 kPA) and the appliance must be isolated from the gas supply piping system by closing its individual manual shutoff valve during any pressure testing of the gas supply system at test pressures equal to or less than 1/2 PSIG (3.45 kPA).

Test for gas leaks. Use a commercial leak detector or a soap and water solution.

## INSTALLATION CONT'D

### COUNTER TOP INSTALLATION

Legs must be installed on this appliance if it is to be configured as a counter top model.

Attach the legs to the body by screwing the threaded stud of the leg into the nut insert provided under each bottom corner of the machine. Tighten each leg with a wrench.

Adjust the legs so that burners are level. Leg adjustment is made by turning the adjustable foot at the bottom of each leg. Ensure that the leg does not turn while adjusting the foot.

### WALL HUNG INSTALLATIONS

The illustration, below, shows the connection points for the gas and electrical and how the wall bracket is to connect to the Cheese Melter.

The heat shield is shipped in the 4-inch space at the rear of the machine.

Instructions for installing the heat shield are provided with the shield. Follow the instructions carefully. It is important to remember to remove the knockouts from the front edge of the machine after the heat shield is installed.

Minimum clearance from the cooking surface below to the bottom of this appliance is 17 inches.

A wall hanging bracket is provided. It is shipped in the 4 inch space at the rear of the machine. Attach the bracket to the wall studs then hang the machine on the bracket.

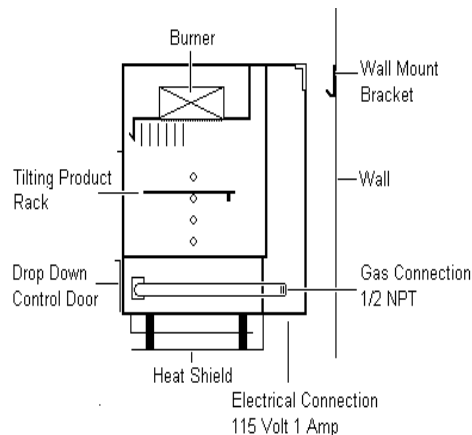

**GAS MELTER**

- 1) Verify connections at plug and terminal block.
  
- 2) Incoming Volt - Single Phase L1\_\_\_\_\_
  
- 3) Gas pressure is set for 6” WC (Natural Gas), 10” WC (Propane). Ensure that the regulator is installed in the correct direction.
  
- 4) Ensure Melter burners are level.
  
- 5) Confirm that on wall mount units installed over high heat sources that heat shield (provided with all wall mount units) is installed and minimum distance is 22”.
  
- 6) Ensure that burner flame is stable and not lifting off of burner. (Flame should be tight against burner and have orange tips.)
  
- 7) Ensure that spark electrode does not continue to spark after ignition. The tip of the spark electrode and sensor electrodes must have flame on them and glowing red.

Model #\_\_\_\_\_ Date\_\_\_\_\_ Serial #\_\_\_\_\_

Store #\_\_\_\_\_ Tech Name\_\_\_\_\_

Contact\_\_\_\_\_ Company \_\_\_\_\_

Store Phone # \_\_\_\_\_ Service Company Phone # \_\_\_\_\_

Address\_\_\_\_\_

\_\_\_\_\_

\_\_\_\_\_



## GENERAL

The Lang Gas Cheesemelter can be used to poach, sauté and brown. In addition to melting cheese on sandwiches, French onion soup, hot apple pie and casseroles, it may be used for finishing Italian, Mexican and au gratin dishes utilizing less energy than conventional broilers.

The product is heated with 1650° of infrared heat, which penetrates the product preventing burning and scorching. The rack is counterbalanced so that maximum heat is supplied only when the product is placed in the rack.







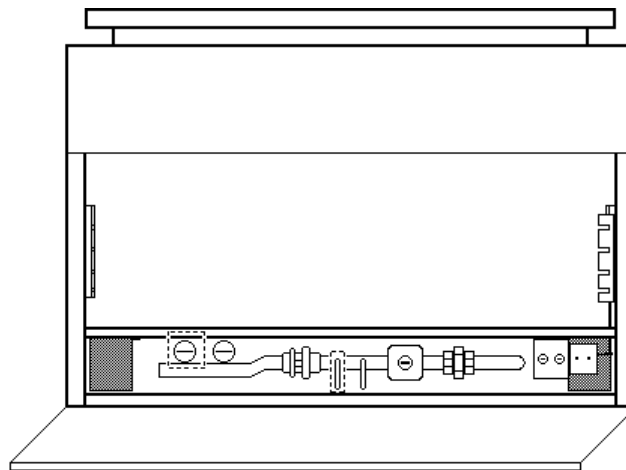

Although the heating elements are not directly controlled to regulate heat, the exposure of the product to heat is adjustable. Heat adjustment may be obtained by raising and lowering the rack position. The shelf positions provide a choice of cooking positions for a variety of applications. The top position is very hot, and can be used for quick browning and toasting, with the heat decreasing at each lower position.

In order to change positions, simply slide the rack in and out of the slots provided. Make sure that the end of the rack engages the sliding mechanism located on the right front corner.

## CONTROLS

There are very few controls that operate the gas Cheese Melter. Below is a list of the various components with a description of their purpose.



- |   |  |
|---|--|
|  Manual On - Off Valve |  Pipe Union                                   |
|  Electric Solenoid     |  Power and Constant Auto Switches             |
|  Pilot Burner Adjuster |  Product Rack Switch                          |
|  Regulator             |  |
|                        |  These components on 4 and 5 Foot Models Only |

## GENERAL CONT'D

Power Switch	Turns the unit On and Off.
Constant - Auto Switch	When set to Constant, the burner(s) will light and stay on. When set to Auto, the burner(s) will light whenever a product is placed onto the Tilting Product Rack.
Manual Gas Valve	This valve turns off the flow of gas to the burner(s). Once the machine is installed, this valve need not be turned off as the Power Switch should be utilized to shut the machine down. The manual gas valve <b>cannot</b> be used to regulate the heat output from the burner(s), it must be full On or full Off.
Tilting Product Rack	The Tilting Product Rack is used to adjust the amount of heat a product is exposed to and to start the burner(s) when the machine is placed into the Auto mode. Raising the Tilting Product Rack increases the heat on the product while lower the rack decreases the heat.

### **OPERATING DO's and DON'Ts**

#### **DO:**

- Insure all dishes placed in the cheesemelter are oven safe.
- Pre-heat pans in the cheesemelter or on a stove.
- Turn products halfway through cooking, as needed.
- Use the unit in Automatic as much as possible, use Constant during peak periods.

#### **DON'T:**

- Do not use the cheesemelter as a cooking or baking device, it is best suited for finishing dishes immediately prior to serving.
- Do not use the unit to heat or thaw chilled or frozen product.
- Do not place aluminum foil on the rack or bottom shelf. This will reflect heat and expose components to unnecessary high temperatures.
- Do not move rack from one position to another without hand protection.

## SEQUENCE OF OPERATION

### **Power switch turned to on:**

- 120 VAC to Solenoid valve.
- Pilot lit manually.
- Pilot confirmed through flame switch.
- 120 VAC to Constant / Auto switch.

### **Auto / Constant switch to “Auto” position.**

- 120 VAC to Rack sensitive to shelf switch.

Rack switch activated.

- Main burner ignition.

### **Auto / Constant switch to “Constant” position.**

- Main burner ignition.

# TROUBLESHOOTING

## NO POWER

PROBABLE CAUSE	CORRECTIVE ACTION
Defective outlet	➤ Confirm that outlet is putting out 120 VAC single phase.
Tripped Circuit Breaker	➤ Confirm that breaker is set in proper position.
Defective Power Cord	➤ Confirm that power cord has continuity through it.
Defective Power Switch	➤ Confirm that power switch is operating correctly.

## NO PILOT

PROBABLE CAUSE	CORRECTIVE ACTION
Plugged orifice	➤ Clean plugged orifice. ➤ Replace if necessary.
Faulty regulator	➤ Clean air vent located on the top of the regulator behind W/C adjustment. ➤ Replace if necessary.
Incorrect Water Column	➤ Set regulator for correct W/C. (6" for NG, 10" for LP)

## **NO BURNER**

<b>PROBABLE CAUSE</b>	<b>CORRECTIVE ACTION</b>
<b>Auto / Constant switch in incorrect position.</b>	<ul style="list-style-type: none"><li>➤ Confirm that in “Constant” position that main burner activates.</li><li>➤ Confirm that in “Auto” position that main burner activates only when product is placed on the rack.</li><li>➤ Replace as necessary.</li></ul>
<b>Faulty regulator</b>	<ul style="list-style-type: none"><li>➤ Clean air vent located on the top of the regulator behind W/C adjustment.</li><li>➤ Replace if necessary.</li></ul>
<b>Plugged Main orifice</b>	<ul style="list-style-type: none"><li>➤ Clean plugged orifice.</li><li>➤ Replace if necessary.</li></ul>
<b>Incorrect Water Column</b>	<ul style="list-style-type: none"><li>➤ Set regulator for correct W / C (6” for NG, 10” for LP)</li></ul>
<b>Faulty Solenoid valve</b>	<ul style="list-style-type: none"><li>➤ Check for 120 VAC, 1100 <math>\Omega</math> on valve.</li><li>➤ Replace if necessary.</li></ul>
<b>Low pilot</b>	<ul style="list-style-type: none"><li>➤ Adjust pilot screw on the manifold right next to regulator.</li><li>➤ Clean orifice.</li><li>➤ Replace if necessary.</li></ul>
<b>Faulty flame switch</b>	<ul style="list-style-type: none"><li>➤ Confirm that pilot is strong and that flame sensor is red.</li><li>➤ Replace if necessary.</li></ul>
<b>Plugged or cracked tile assembly.</b>	<ul style="list-style-type: none"><li>➤ Replace tile assembly.</li></ul>

## TECHNICAL DATA

### MELTER LINE AMPERAGE, AND WATTAGE

Model Number	Total BTU		Number of Connections	Electrical Conn.		Gas Pressure		Clearances			Weight
	NG	LP		VAC	AMPS	NG W/C	LP W/C	Sides	Back	Bottom	
0-2-10-3	30,000	30,000	One 1/2 NPT	115V	1.0	6"	10"	6"	0"	12"	230 lbs
0-2-10-4	40,000	40,000	One 1/2 NPT	115V	1.0	6"	10"	6"	0"	12"	300 lbs
0-2-10-5	50,000	50,000	One 1/2 NPT	115V	1.0	6"	10"	6"	0"	12"	340 lbs

# WIRING DIAGRAM GAS MELTER

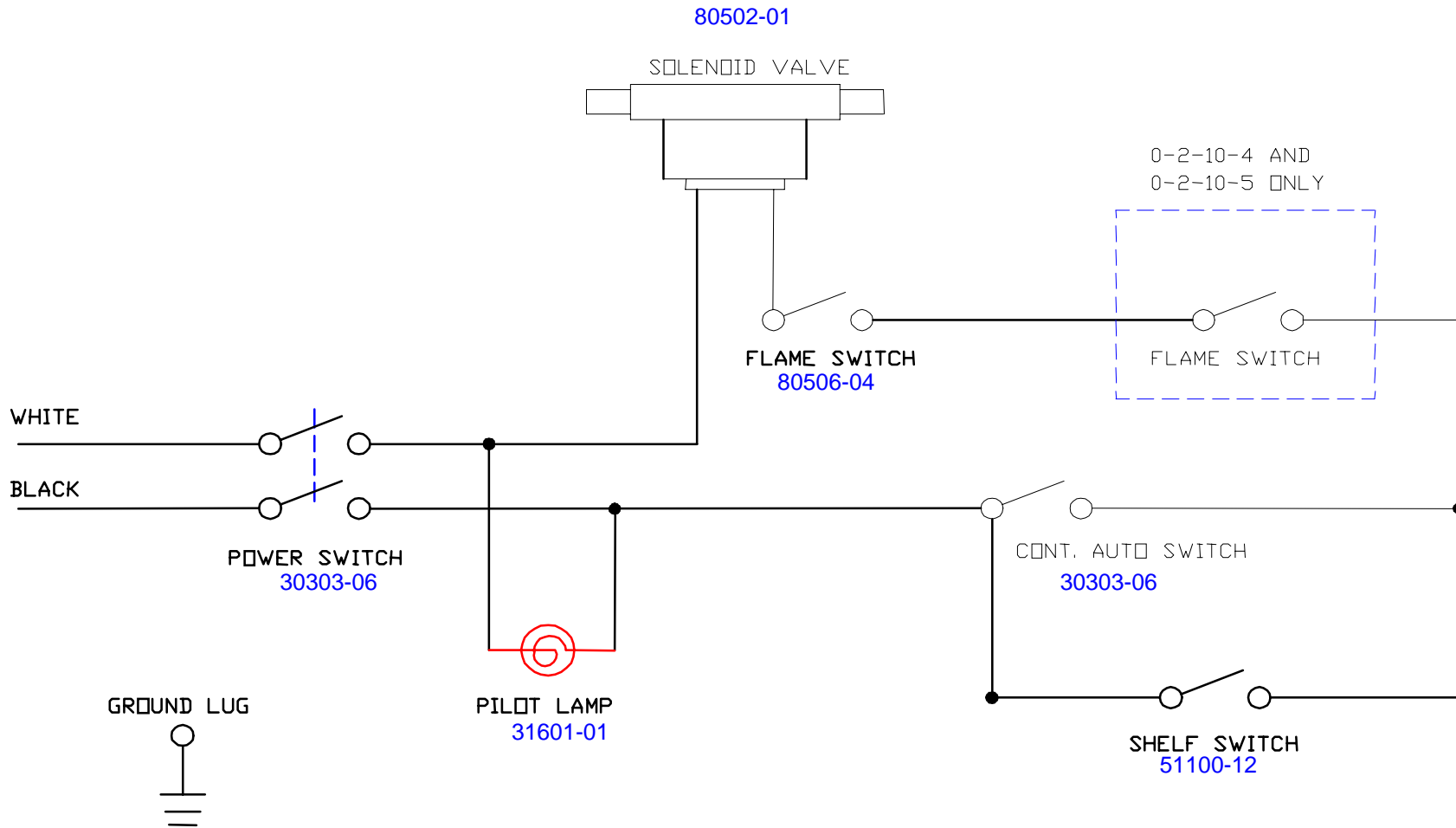

● = WIRE NUT

**0-2-10-3, 0-2-10-4, 0-2-10-5****GAS CHEESE MELTER**

<b>DESCRIPTION</b>	<b>PART NO.</b>
Switch Toggle On-Off	30303-06
Pilot Light 208/240V 6" Lead Black Body	31601-01
Spring Regulator LP	51001-10
Spring Regulator NG	51001-11
Micro Switch Assembly	51100-12
Pilot Burner Assembly Mod. Kit (Before D-52897)	60101-18
Valve Manual Main Burner, 4ft & 5ft Units	70402-05
Valve Manual Gas Pilot Burner	70402-06
Valve Manual Main Burner, 3ft Units	70402-07
Catch Magnetic Door	70602-06
Knob Gas On-Off Chrome	70701-43
Infrared Gas Burner 15 5/16" Long, 4ft & 5ft Units	80005-01
Infrared Gas Burner 26 7/8" Long, 3ft & 5ft Units	80005-02
Manifold Gas Melter, 3ft, 4ft & 5ft Units	80100-10
Manifold Gas Melter, 4ft & 5ft Units	80100-11
Pilot Burner Assembly (After D-52897)	80201-20
Orifice Pilot Burner .010 DRL LP	80401-09
Orifice Pilot Burner .021 DRL NG	80401-11
Orifice Gas Spud #42 DRL NG 30k for 26 7/8" Burner	80404-03
Orifice Gas Spud #48 DRL NG 20k for 15 5/6" Burner	80404-09
Orifice Gas Spud #52 DRL LP 30k for 26 7/8" Burner	80404-13
Orifice Gas Spud #55 DRL LP 20k for 15 5/6" Burner	80404-16
Orifice Gas Spud #45 DRL NG for 15 5/16" Burner (Chili's Units Only)	80404-23
Orifice Gas Spud #38 DRL NG for 26 7/8" Burner (Chili's Units Only)	80404-24
Orifice Gas Spud #54 DRL LP for 15 5/16" Burner (Chili's Units Only)	80404-27
Orifice Gas Spud #50 DRL LP for 26 7/8" Burner (Chili's Units Only)	80404-28
Regulator Gas Set 6" NG	80501-01
Regulator Gas Set 10" LP	80501-03
Valve Solenoid Gas 120 VAC	80502-01
Flame Switch 36" Long Capillary	80506-04