

## Wiring Diagrams

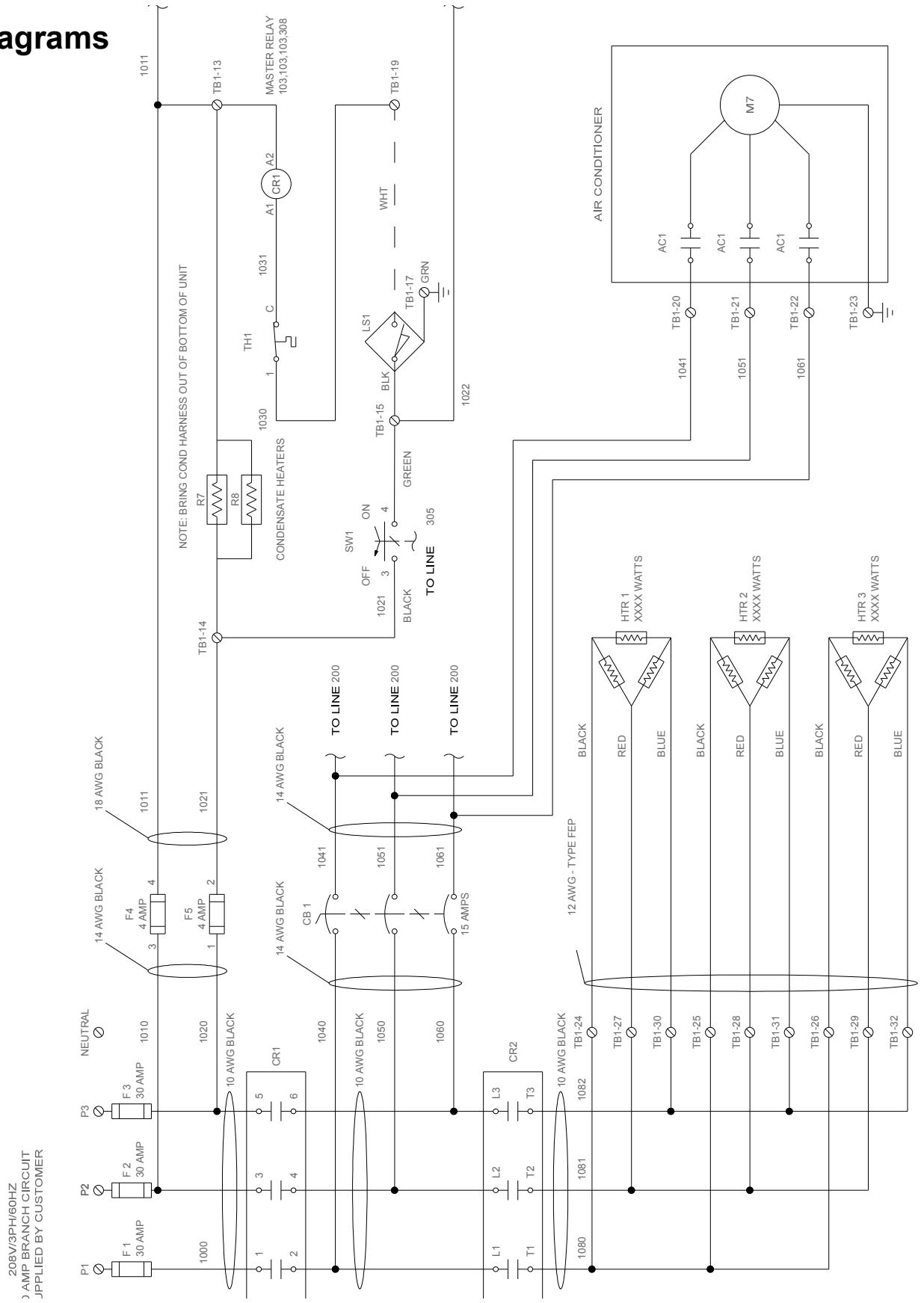

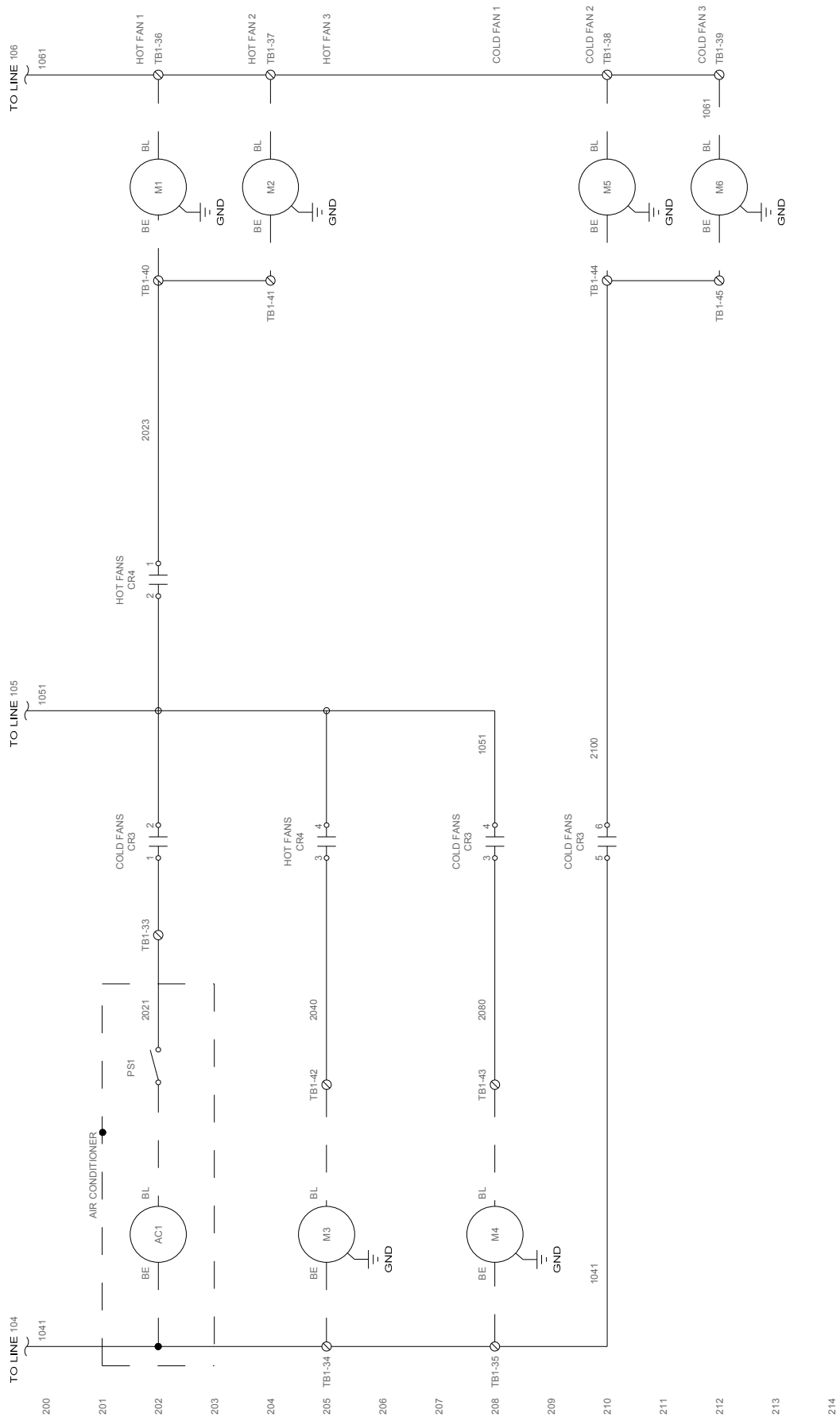



KEY	QTY	MANUFACTURER	CATALOG NUMBER	DESCRIPTION
1	1	MEAN WELL	HDR-60-24	AC/DC POWER SUPPLY, 24VDC FOR LINEAR ACTUATOR
2	1	MEAN WELL	HDR-60-15	AC/DC POWER SUPPLY, 15VDC FOR NUC CONTROLLER
3	2	OMRON	LY2-DC24	24V DC RELAY, 10A, DPDT
4	2	OMRON	PTF08A-E	Socket (24V relay) for DIN rail
5	2	PHOENIX CONTACT	3032350	End Anchor, screwless
6	4	DUFF-NORTON	LT1002-50	ACTUATOR W/ DC MOTOR
7	2	AMERICAN ELECT. INC	TSS575SL	DIN RAIL, 35MM X 7.5MM SLOTTED
7	7	MEMORY PROTECH DEVICES	172-4000	CONNECTOR BARREL 5.5MM DIA. FOR NUC

**AC/DC  
POWER  
SUPPLY  
90-264VAC  
DOUBLE INSULATED  
2.5 A MAX OUT**

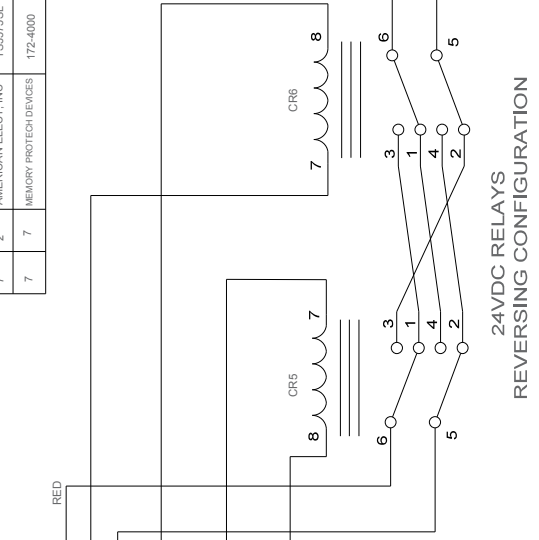
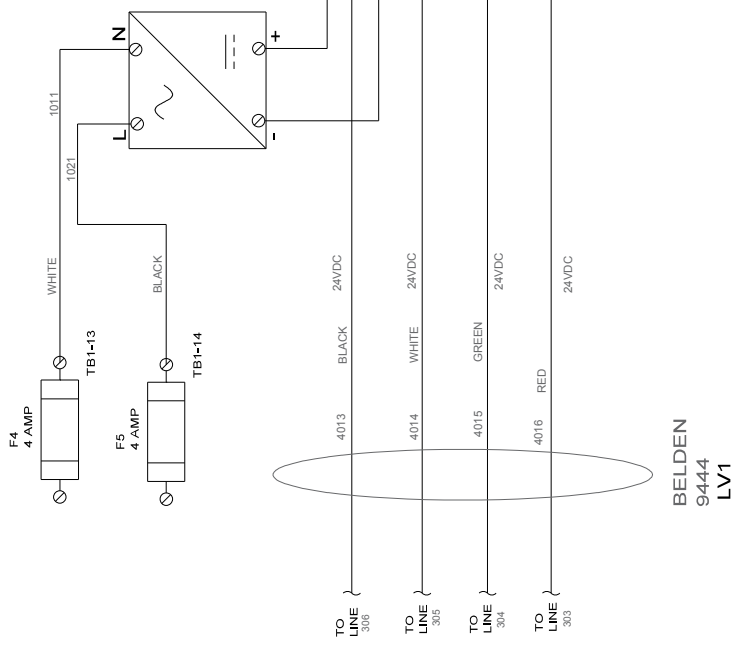

**24VDC RELAYS  
REVERSING CONFIGURATION**

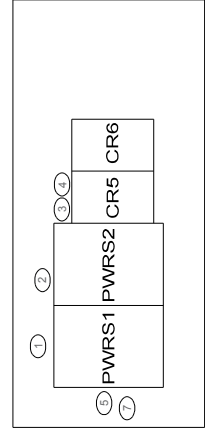

**DC Motor  
REVERSIBLE**  
Harness Lengths  
M1: 7'

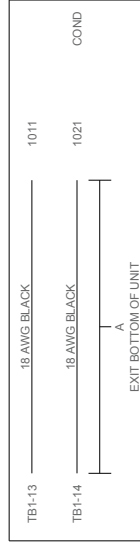
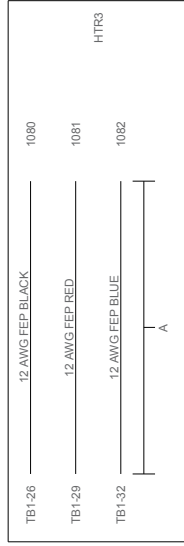
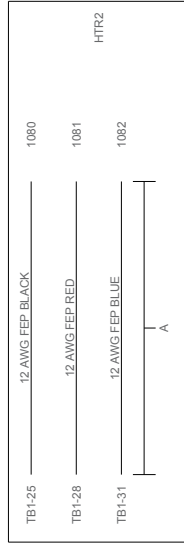
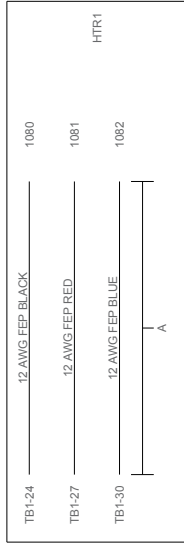

CABLE	LENGTH
SW1	7'
PS	7'
AC PWR	7'
HV1	7'
HV2	7'
LV1	7'
LV2	7'
LV3	7'
COND	7'
HTR1	7'
HTR2	7'
HTR3	7'
SV1	7'
SV2	7'
PARALOOP (PL)	7'

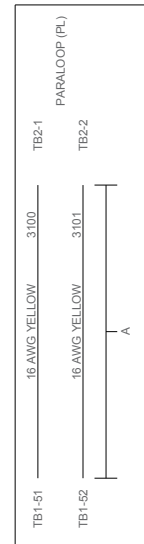
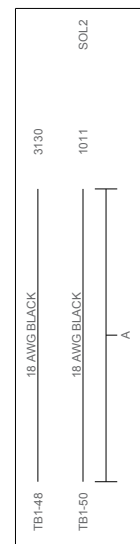
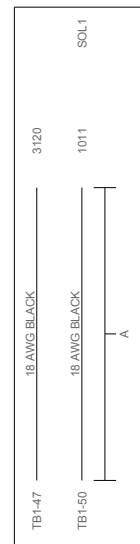
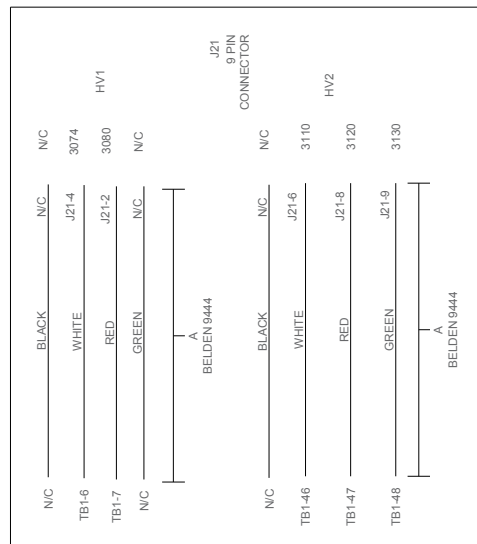
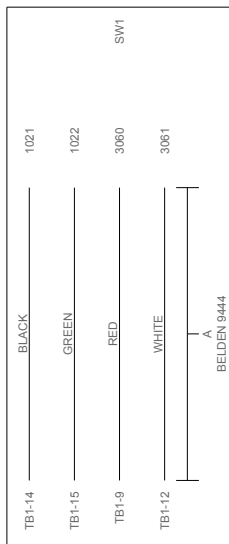
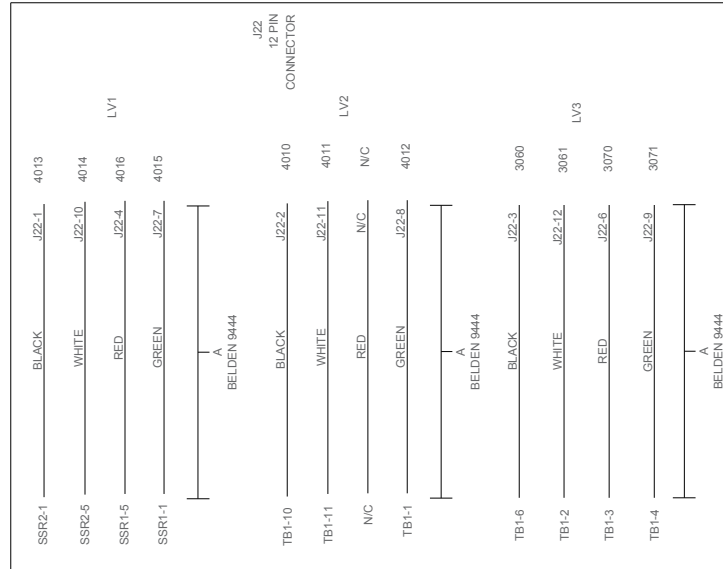
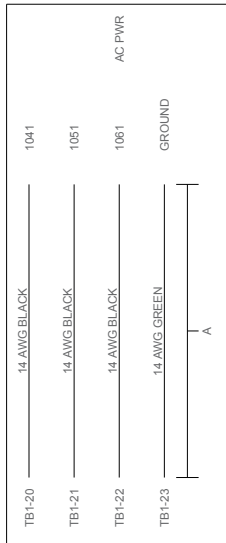
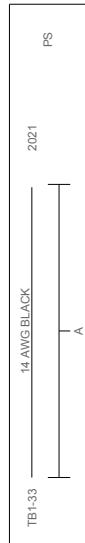

# OPTIONAL SAFE TEMP II WI-FI WIRING DIAGRAM

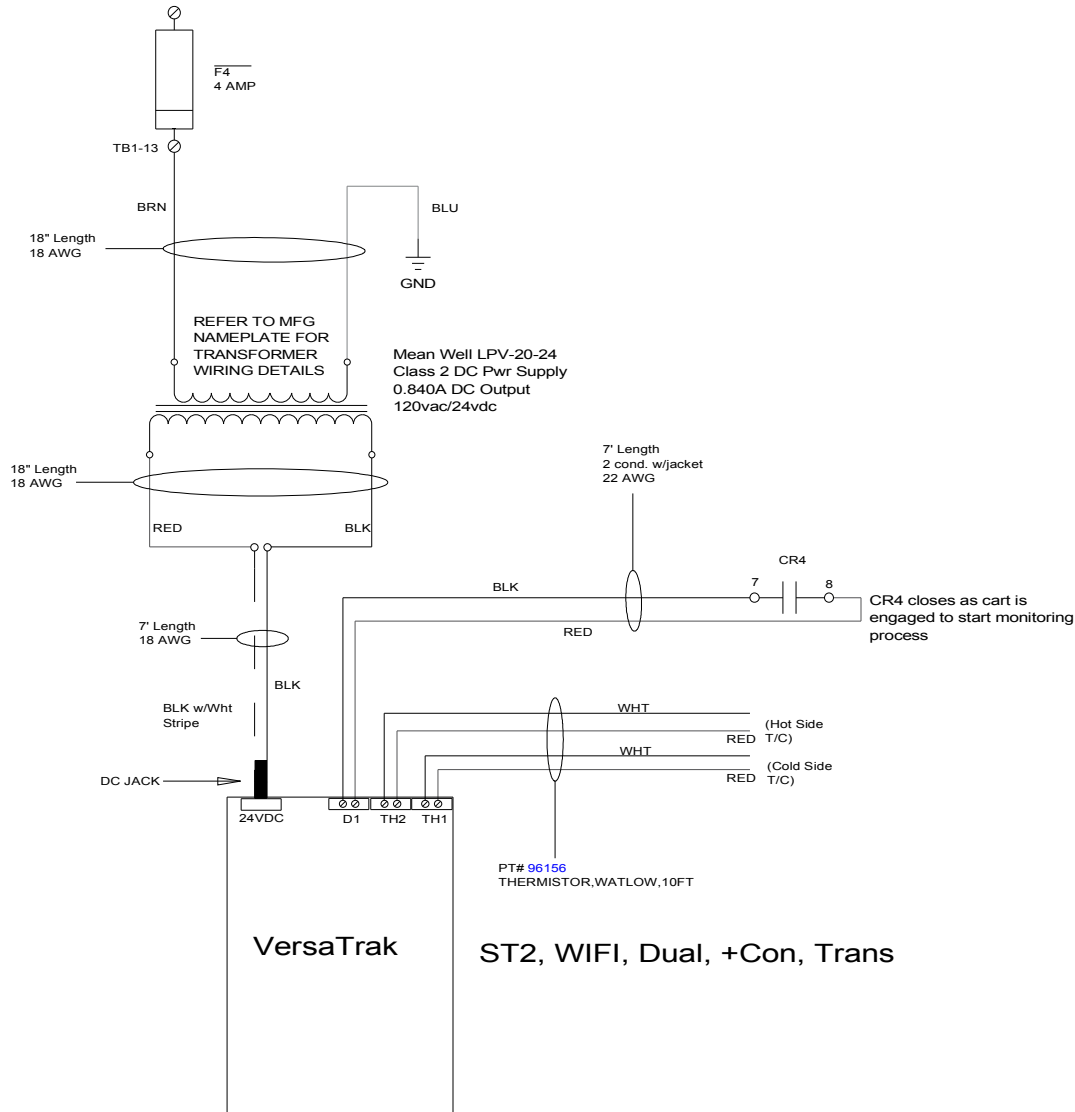

## Harness Lengths

- D1: 7'
- DC Jack: 7'
- BRN / BLU: 18"
- RED / BLK: 18"
- TH1: 10'
- TH2: 10'