

ALTO SHAAM®

OPERATION and CARE MANUAL



HOT & COLD MERCHANDISER

1000-HCM

HALO  **HEAT. COOK/HOLD/SERVE SYSTEMS**



W164 N9221 Water Street • P.O. Box 450 • Menomonee Falls, Wisconsin 53052-0450 U.S.A.

PHONE: 262.251.3800

800.558.8744 U.S.A./CANADA

FAX: 262.251.7067 • 800.329.8744 U.S.A. ONLY

262.251.1907 INTERNATIONAL

WEBSITE:

www.alto-shaam.com

ALTO-SHAAM®- MERCHANDISERS

UNPACKING and SET-UP

The Alto-Shaam Hot & Cold Merchandiser has been thoroughly tested, checked for calibration, and inspected to insure only the highest quality cabinet is provided. When you receive your cabinet, check for any possible shipping damage and report it at once to the delivering carrier. See

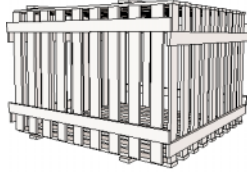

Transportation Damage and Claims section located in this manual.

The cabinet, complete with unattached items and accessories, may be delivered in one or more packages. Make certain the number of packages received matches the packing list and the accompanying bill of lading.

Save all the information and instructions packed inside the cabinet. Complete and return the warranty card to the factory as soon as possible to insure prompt service in the event of a warranty parts and labor claim.

The unit should NOT be used in any area where it may be affected by steam, grease, dripping water, high temperatures, drafts from ventilator openings, radiant heat from light fixtures that are too close or any other severely adverse conditions. The case is designed to be used in areas that maintain a temperature at or below 75°F (24°C) dry bulb and a 55% relative humidity. The case must be installed level in order for the drain in the refrigerated section to work properly.

The unit must be bolted to its base. In order to maintain standards established by the National Sanitation Foundation, stationary models mounted directly on top of an base must be sealed to both the base and the floor with a R.T.V. or silastic meeting N.S.F. requirements. Counter and table units must be mounted on legs of a sufficient 4" height to provide minimum unobstructed space beneath the unit. Any countertop mounted installations must have adequate ventilation at the bottom of the unit for proper air circulation. (Refer to counter layout in this manual).

NOTE: Any claims for warranty must include the full model number and serial number of the cabinet.

ELECTRICAL INSTALLATION

An identification tag is permanently mounted on the cabinet.

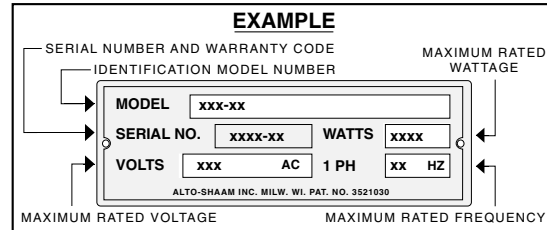

ENSURE POWER SOURCE MATCHES VOLTAGE STAMPED ON NAMEPLATE OF UNIT

A proper receptacle or outlet configuration, as required for this unit must be installed by a licensed electrician in accordance with applicable, local electrical codes. Permanent wiring for this unit must be installed by a licensed electrician in accordance with applicable local electrical codes. Position the merchandiser so that the power supply cord is easily accessible in case of an emergency.

WARMING CHARACTERISTICS

The cabinet is equipped with a special, low-heat-density, heating cable. Through the Halo Heat concept, the heating cable is mounted against the walls of the warming compartment to provide an evenly applied heat source, controlled by an electronic thermostat. The design and operational characteristics of the unit eliminates the need for a moisture pan or a heat circulating fan. Through even heat application, the quality of a food product is maintained for short periods or for longer time periods, up to several hours. The heated compartment is equipped with an electronic thermostat, pilot light, and digital display to monitor inside air temperature.

REFRIGERATION CHARACTERISTICS

The cabinet is equipped with a 1/3 horsepower compressor, R-404A refrigerant, low pressure safety switch in the event a refrigerant leak should occur, and a timer/defrost mechanism. Each cabinet is equipped with an electronic thermostat and digital display to monitor inside air temperature.

START-UP

1. Before operating the merchandiser, clean the interior and exterior of the unit with a damp cloth and mild soap solution. Rinse carefully.
2. Clean and install the cabinet wire shelves inside the hot and cold cavities, the bottom baffle pan in the hot cavity, and the external condensate drip pan underneath the cold cavity.
3. Clean glass with a window cleaner.
4. After final hook-up, locate the circuit breaker box under the unit and flip breaker switches to the ON position for full power to the merchandiser.
5. Let the case run through at least one defrost before loading with product, checking the duration of defrost (preferably two or more) and frequency, to make sure the case is defrosting properly. Check the operating temperature to make sure the case is functioning within the guidelines recommended for this case.

OPERATIONAL PROCEDURES

1. SETTING TIMER / DEFROST MECHANISM.

The timer/defrost mechanism is located behind the end panel on the refrigerated side of the merchandiser. The panel can be removed by unscrewing two screws located at the top of the panel. Lift up and slide bottom of panel out to remove. Press spring clip at right center of timer defrost box and open the metal case door.

- A. To set the time of day, grasp knob in the center of the inner 2-hour dial and rotate it in a counter-clockwise direction. This will revolve the outer dial. Line up the correct time of day on the outer dial with the time pointer. **Do not try to set the time control by grasping the outer dial. Rotate the inner dial only.**
- B. To set the mechanical defrost termination, push down and rotate the copper pointer on the inside 2-hour dial until it is opposite the desired time. Twenty (20) minutes is recommended in order to avoid frost build-up on the coils and avoids warming of products kept in the cold compartment.
- C. Slide the screw start pins out of the holder on the right side and place the start pins in the outer 24-hour dial at the time of day that the defrosting should occur, and screw into place. **Caution:** Leave at least 1 hole between each adjacent pin. It is recommended that the start pins be placed every 6 hours to coincide with off-peak times such as before the store opens, after the store closes and lull periods during the business day to prevent the excess loss of chilled air when the doors are continuously being opened.

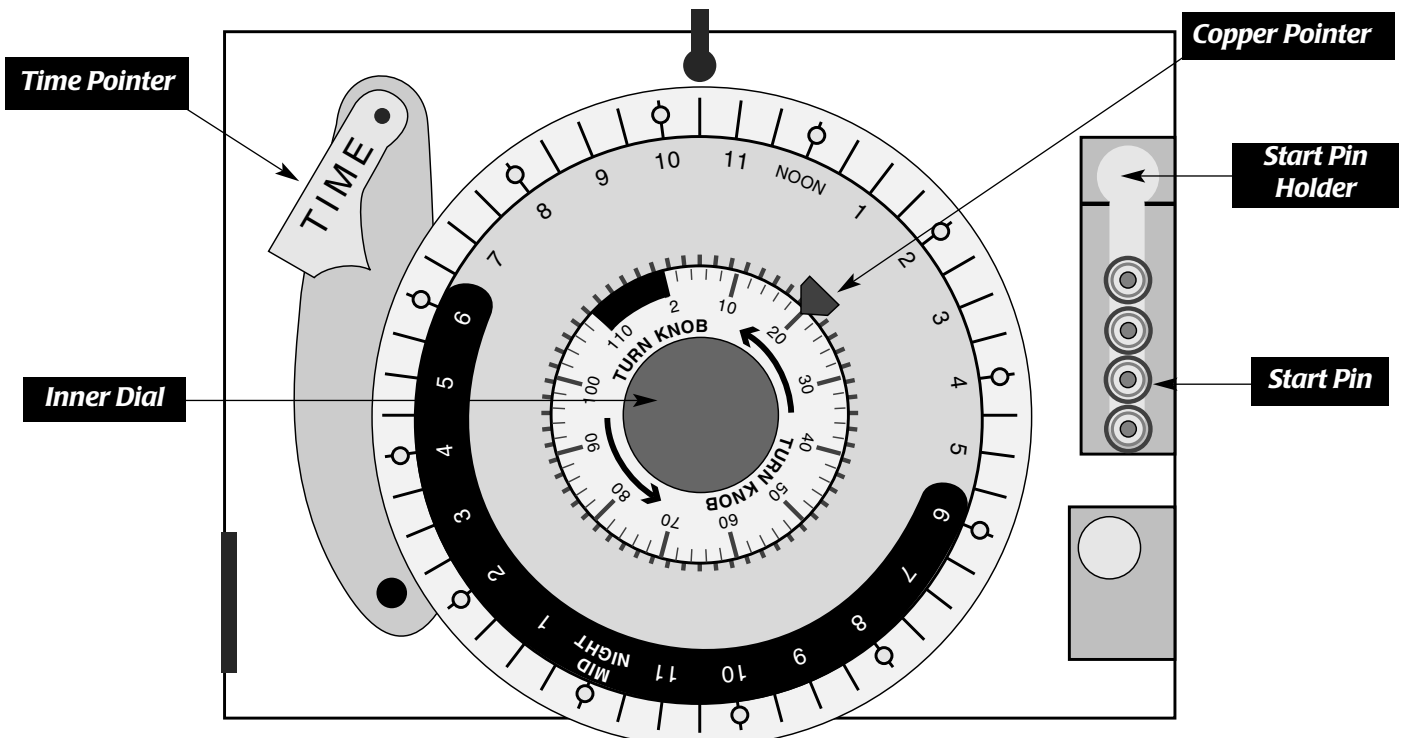

OPERATIONAL PROCEDURES

Thermostat Control Description and Function

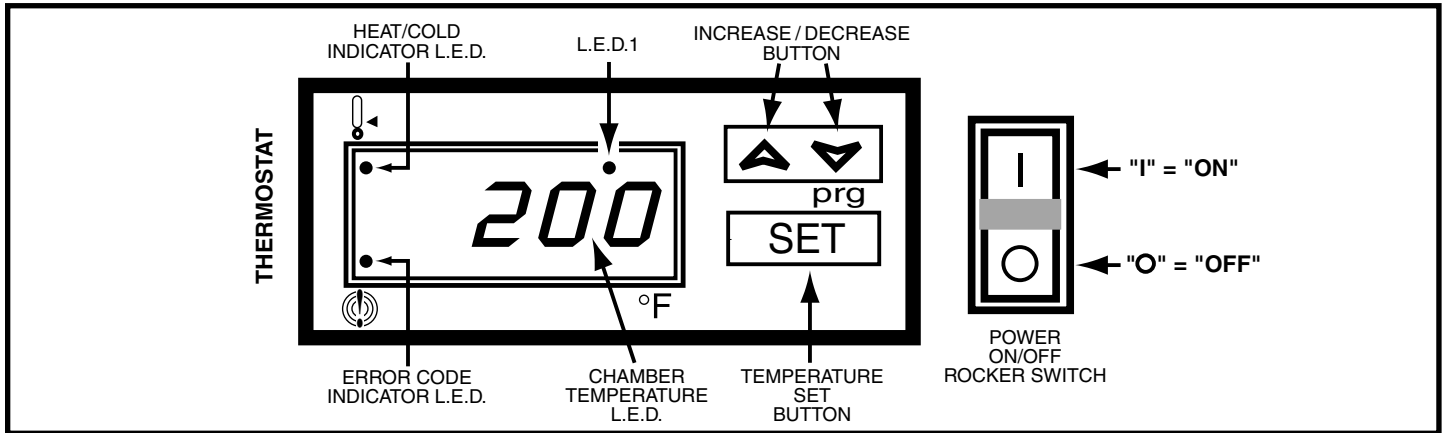

The L.E.D., Light Emitting Diode, referred to is an electronic device providing illumination. The control has a three-digit L.E.D. display. When the warm or cold cabinet is in operation, the L.E.D. will show the chamber's internal temperature. The display will also show programming and diagnostic information.

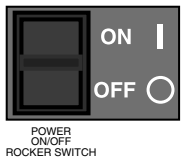

ON/OFF Rocker Switch

The Power On/Off Rocker Switch positions may be marked with the international "I" for On and "O" for Off.



UP/DOWN Arrow Rocker Button

The UP/DOWN arrow rocker button is used to increase or decrease the set-point temperature. The minimum set-point temperature for the hot side is 90°F (32°C) while the maximum set-point temperature is 200°F (93°C). The temperature range for the cold side is 27°F to 40°F (3°C to 5°C).



SET Button

The SET button is used to display the current set-point temperature or program a new set-point temperature. Pushing the SET button once will display the set-point temperature value for five seconds. Holding the SET button allows the programming mode to become active.

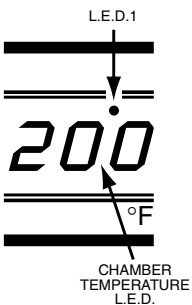

L.E.D. Display

The L.E.D. display will show the set-point temperature value when programming, or the warm or cold chamber's temperature when calling for heat or cold. When programming a new set-point temperature, the L.E.D.1 indicator will blink. When a new set-point temperature is chosen, the Chamber Temperature L.E.D. will flash three times to confirm.

HEAT or COLD INDICATOR L.E.D.

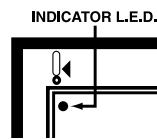

The Heat or Cold Indicator L.E.D. will illuminate and remain lit while the unit is calling for heat or cold. It will go out when the air temperature inside the chamber reaches the set-point temperature on the control.

ERROR CODE DISPLAYS

Open-Circuited

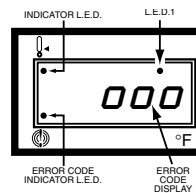

If "000" is displayed in the Error Code L.E.D., the sensor is open-circuited. Follow Trouble Shooting Guide instructions in this Operation and Care Manual.

Short-Circuited

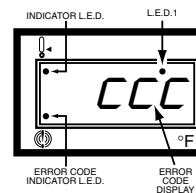

If "CCC" is displayed in the Error Code L.E.D., the sensor is short-circuited. Follow Trouble Shooting Guide instructions in this Operation and Care Manual.

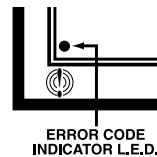

ERROR CODE INDICATOR L.E.D.

If either of the above mentioned errors codes should occur, the Error Code Indicator L.E.D. will be illuminated and remain so until error is cleared.

OPERATIONAL PROCEDURES

Programming and Operating Thermostat Control

Turn Power On

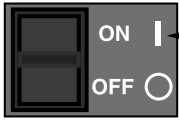

Press the "ON" or "I" position of the rocker switch to turn on control.

CHANGE SET-POINT TEMPERATURE



+



Press and hold the SET button for at least 3 seconds. After L.E.D.1 indicator blinks, release the Set Button. The control is now in the programming mode. **Press and hold** the UP or DOWN arrow rocker button to change the value shown in the display. Store the value by pressing the SET button.

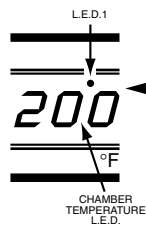

The new set-point value will flash three times to confirm.

HEAT or COLD INDICATOR L.E.D.

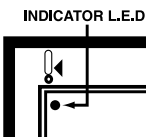

The Indicator L.E.D. will illuminate as the warming or cooling chamber calls for heat or cold. It will extinguish when the chamber's interior temperature reaches the set-point.

PREHEATING or PRECHILLING THE UNIT

Always preheat the warming chamber at 200°F (93°C) for 30 minutes before loading the merchandiser with hot food. Always prechill the cooling chamber at 36°F (2°C) for 60 minutes before loading with cold food.

LOADING THE CABINET

Load the merchandiser with **hot or cold food only**. The purpose of this unit is to maintain hot food or cold food at proper serving temperature. Use a food thermometer to make certain all hot food has reached an internal temperature range of 140° to 160°F (60° to 71°C). Do not fill cabinet

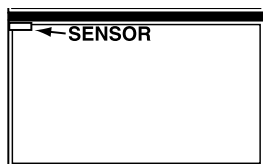

closer than 2" from the sensor. Make certain door is securely closed after loading. Reset the control to 160°F (71°C) for hot food or 37° to 40°F (3° to 4°C) for cold food. **This will not neces-**

sarily be the final setting. Proper temperature range for the food being held will depend on the type and quantity of product. It is advisable to periodically check the internal temperature of each item to assure maintenance of proper food serving temperature.

CAUTION

The unit should be unplugged and a qualified service technician should be consulted if any of the following situations occur:

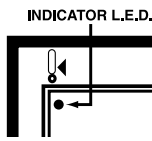

- The Indicator L.E.D. does not illuminate after normal start-up.
- The warm or cool cabinet does not hold the temperature as set.
- The cabinet fails to heat or cool with the L.E.D. illuminated.
- The cabinet heats or cools continuously with the control "OFF".
- Refer to Trouble Shooting Guide in this manual.

ELECTRONIC CONTROL ACCURACY

The electronic control is a precise instrument and is designed to offer trouble-free service. If you suspect the temperature inside the cabinet does not match the temperature indicated on the digital display, after stabilizing, follow the instructions listed below.

1. Make certain the power meets the requirements of the appliance, voltage and current rating as indicated on identification tag.
2. Verify the temperature inside the cabinet with a quality thermal indicator.
 - A. With the exception of the metal shelves, completely empty the cabinet.
 - B. Make certain the sensor, located inside the cabinet at the ceiling, is completely clean.
 - C. Suspend the thermal indicator in the center of the cabinet.
 - D. Allow the temperature, set on the electronic thermostat, to stabilize for a minimum of one hour before comparing the digital display with the reading on the thermal indicator.

DO NOT OPEN THE CABINET DOOR(S) DURING THE TEMPERATURE STABILIZATION PERIOD.

If the reading on the thermal indicator does not match the digital display within 10°F (6°C), contact a qualified service technician for appropriate action.

OPERATIONAL PROCEDURES

HEATED COMPARTMENT

1. PREHEAT AT 200°F (93°C) FOR 60 MINUTES.

The electronic thermostat is preset at the factory at 175°F (79°C). Set the electronic thermostat to 200°F (93°C). The heat indicator "OUT" light will illuminate and remain lit while the unit is calling for heat. Allow a minimum of 60 minutes for preheating before loading the merchandiser with product. The digital display will indicate air temperature of the heated compartment. The heat indicator "OUT" light will go out when the air temperature inside the unit reaches the temperature set on the electronic thermostat.

2. LOAD THE HEATED COMPARTMENT WITH HOT FOOD ONLY.

The purpose of the Hot & Cold Merchandiser is to maintain hot food at proper serving temperature inside the hot cavity section. **Only hot food should be placed into the heated compartment of the merchandiser.** Before loading the merchandiser with food, use a food thermometer to make certain all products have reached an internal temperature range of 165°F (74°C). Any food product not within the proper temperature range should be heated before loading it into the heated compartment. For best results, use a Halo Heat Cooking and Holding Oven or Combitherm Oven to bring the product within the correct temperature range.

3. RESET THE THERMOSTAT TO 180°F (82°C).

After the compartment has been filled with product, check to make certain the doors are securely closed, and reset the thermostat to 180°F (82°C).

The proper temperature range for the products being held will depend on the type and quantity of product. When holding food for prolonged periods, it is advisable to periodically check the internal temperature of each item with a food thermometer to assure maintenance of the proper temperature range of 150° to 160°F (66° to 71°C).

4. WHEN NOT IN USE, TURN POWER SWITCH OFF.

REFRIGERATED COMPARTMENT

1. PRE-CHILL AT 36°F (2°C) FOR 60 MINUTES.

The electronic thermostat is preset at the factory at 36°F (2°C). The indicator "OUT" light will illuminate and remain lit while the unit is calling for cold air. Allow a minimum of 60 minutes for pre-chilling before loading the merchandiser with product. The digital display will indicate air temperature of the refrigerated compartment. The cold indicator "OUT" light will go out when the air temperature inside the unit reaches the temperature set on the electronic thermostat.

2. LOAD THE COLD COMPARTMENT WITH CHILLED FOOD ONLY.

The purpose of the Hot & Cold Merchandiser is to maintain cold food at proper serving temperatures inside the cold cavity section. **Only chilled food should be placed into the refrigerated compartment of the merchandiser.** Air flow for the refrigeration compartment must be kept clear on both ends of the unit.

3. RESET THE THERMOSTAT IF NEEDED.

After the compartment has been filled with product, check to make certain the doors are securely closed, and set the thermostat if needed.

The proper temperature range for the products being held will depend on the type and quantity of product. When holding food for prolonged periods, it is advisable to periodically check the temperature of each item with a food thermometer to assure maintenance of the proper temperature range of 37° to 40°F (3° to 5°C).

4. WHEN NOT IN USE, TURN POWER SWITCH OFF.



SANITATION GUIDELINE

Food flavor and aroma are usually so closely related that it is difficult, if not impossible, to separate them. There is also an important, inseparable relationship between cleanliness and food flavor. Cleanliness, top operating efficiency, and appearance of equipment contribute considerably to savory, appetizing foods. Good equipment that is kept clean, works better and lasts longer.

Most food imparts its own particular aroma and many foods also absorb existing odors. Unfortunately, during this absorption, there is no distinction between *GOOD* and *BAD* odors. The majority of objectionable flavors and odors troubling food service operations are caused by bacteria growth. Sourness, rancidity, mustiness, stale or other *OFF* flavors are usually the result of germ activity.

The easiest way to insure full, natural food flavor is through comprehensive cleanliness. This means good control of both visible soil (dirt) and invisible soil (germs). A thorough approach to sanitation will provide essential cleanliness. It will assure an attractive appearance of equipment, along with maximum efficiency and utility. More importantly, a good sanitation program provides one of the key elements in the prevention of food-borne illnesses.

A controlled holding environment for prepared foods is just one of the important factors involved in the prevention of food-borne illnesses. Temperature monitoring and control during receiving, storage, preparation, and the service of foods are of equal importance.

INTERNAL FOOD PRODUCT TEMPERATURES		
HOT FOODS		
DANGER ZONE	40° TO 140°F	(4° TO 60°C)
CRITICAL ZONE	70° TO 120°F	(21° TO 49°C)
SAFE ZONE	140° TO 165°F	(60° TO 74°C)
COLD FOODS		
DANGER ZONE	ABOVE 40°F	(ABOVE 4°C)
SAFE ZONE	36°F TO 40°F	(2°C TO 4°C)
FROZEN FOODS		
DANGER ZONE	ABOVE 32°F	(ABOVE 0°C)
CRITICAL ZONE	0° TO 32°F	(-18° TO 0°C)
SAFE ZONE	0°F OR BELOW	(-18°C OR BELOW)

The most accurate method of measuring safe temperatures of both hot and cold foods is by internal product temperature. A quality thermometer is an effective tool for this purpose, and should be routinely used on all products that require holding at a specific temperature.

A comprehensive sanitation program should focus on the training of staff in basic sanitation procedures. This includes personal hygiene, proper handling of raw foods, cooking to a safe internal product temperature, and the routine monitoring of internal temperatures from receiving through service.

Most food-borne illnesses can be prevented through proper temperature control and a comprehensive program of sanitation. Both these factors are important to build quality service as the foundation of customer satisfaction. Safe food handling practices to prevent food-borne illness is of critical importance to the health and safety of your customers. HACCP, an acronym for Hazard Analysis (at) Critical Control Points, is a quality control program of operating procedures to assure food integrity, quality, and safety. Taking steps necessary to augment food safety practices are both cost effective and relatively simple. While HACCP guidelines go far beyond the scope of this manual, additional information is available by contacting the USDA/FDA Food-borne Illness Education Information Center at (301)504-6803.

GENERAL HOLDING GUIDELINE

Chefs, cooks and other specialized food service personnel employ varied methods of cooking. Proper holding temperatures for a specific food product must be based on the moisture content of the product, product density, volume, and proper serving temperatures. Safe holding temperatures must also be correlated with palatability in determining the length of holding time for a specific product.

Halo Heat maintains the maximum amount of product moisture content without the addition of water, water vapor, or steam. Maintaining maximum natural product moisture preserves the natural flavor of the product and provides a more genuine taste. In addition to product moisture retention, the gentle properties of Halo Heat maintain a consistent temperature throughout the cabinet without the necessity of a heat distribution fan, thereby preventing further moisture loss due to evaporation or dehydration.

In an enclosed holding environment, too much moisture content is a condition which can be relieved. A product achieving extremely high temperatures in preparation must be allowed to decrease in temperature before being placed in a controlled holding atmosphere. If the product is not allowed to decrease in temperature, excessive condensation will form increasing the moisture content on the outside of the product.

Most Halo Heat Holding Equipment is provided with a thermostat control between 60° and 200°F (16° to 93°C). If the unit is equipped with vents, close the vents for moist holding and open the vents for crisp holding.

HOLDING TEMPERATURE RANGE		
MEAT	FAHRENHEIT	CELSIUS
BEEF ROAST — Rare	140°F	60°C
BEEF ROAST — Med/Well Done	160°F	71°C
BEEF BRISKET	160° — 175°F	71° — 79°C
CORN BEEF	160° — 175°F	71° — 79°C
PASTRAMI	160° — 175°F	71° — 79°C
PRIME RIB — Rare	140°F	60°C
STEAKS — Broiled/Fried	140° — 160°F	60° — 71°C
RIBS — Beef or Pork	160°F	71°C
VEAL	160° — 175°F	71° — 79°C
HAM	160° — 175°F	71° — 79°C
PORK	160° — 175°F	71° — 79°C
LAMB	160° — 175°F	71° — 79°C
POULTRY		
CHICKEN — Fried/Baked	160° — 175°F	71° — 79°C
DUCK	160° — 175°F	71° — 79°C
TURKEY	160° — 175°F	71° — 79°C
GENERAL	160° — 175°F	71° — 79°C
FISH/SEAFOOD		
FISH — Baked/Fried	160° — 175°F	71° — 79°C
LOBSTER	160° — 175°F	71° — 79°C
SHRIMP — Fried	160° — 175°F	71° — 79°C
BAKED GOODS		
BREADS/ROLLS	120° — 140°F	49° — 60°C
MISCELLANEOUS		
CASSEROLES	160° — 175°F	71° — 79°C
DOUGH — Proofing	80° — 100°F	27° — 38°C
EGGS — Fried	150° — 160°F	66° — 71°C
FROZEN ENTREES	160° — 175°F	71° — 79°C
HORS D'OEUVRES	160° — 180°F	71° — 82°C
PASTA	160° — 180°F	71° — 82°C
PIZZA	160° — 180°F	71° — 82°C
POTATOES	180°F	82°C
PLATED MEALS	180°F	82°C
SAUCES	140° — 200°F	60° — 93°C
SOUP	140° — 200°F	60° — 93°C
VEGETABLES	160° — 175°F	71° — 79°C

THE HOLDING TEMPERATURES LISTED ARE SUGGESTED GUIDELINES ONLY

CARE and CLEANING



The cleanliness and appearance of this equipment will contribute considerably to operating efficiency and savory, appetizing food. There is an important relationship between cleanliness and food flavor and aroma. Good equipment that is kept clean works better and lasts longer.

CLEAN THE HOT & COLD MERCHANDISER DAILY.

1. Disconnect the merchandiser from its power source.
2. Remove any left over food products and store in another case.
3. Remove the wire shelves, side racks and baffle pan. Clean these items separately with warm water or commercial detergent. Rinse well with a sanitizing solution.
4. Remove all loose debris which may clog the drain in the refrigerated compartment. Clean the interior walls of the merchandiser with a damp cloth and any good alkaline or alkaline chlorinated based commercial detergent or grease solvent at the recommended strength. Use a plastic scouring pad for difficult areas. Avoid the use of abrasive cleaning

compounds, chloride based cleaners, or cleaners containing quaternary salts. Rinse well to remove all residue and wipe dry. *NOTE: Never use hydrochloric acid (muriatic acid) on stainless steel.*

5. Remove the slide out drain pan underneath the unit, empty and wash with warm soapy water or commercial detergent.
6. To help maintain the protective film coating on polished stainless steel, clean the exterior of the cabinet with a cleaner recommended for stainless steel surfaces. Spray the cleaning agent on a cloth and wipe with the grain of the stainless steel.
7. Remove the pull-out door gasket and wash in hot soapy water or in the dishwasher. Always replace gasket before operating the merchandiser.
8. Clean the glass with a window cleaner.
9. Clean the menu panels with soap or mild detergent and water. Dry with a clean, damp chamois. Grease and oil may be removed with naphtha or hexane. **DO NOT USE HOUSEHOLD CLEANERS CONTAINING AMMONIA.** To avoid scratching, do not use dry cloths or scouring compounds.

Always follow appropriate state or local health (hygiene) regulations regarding all applicable cleaning and sanitation requirements for equipment.

3300-HCM BASE

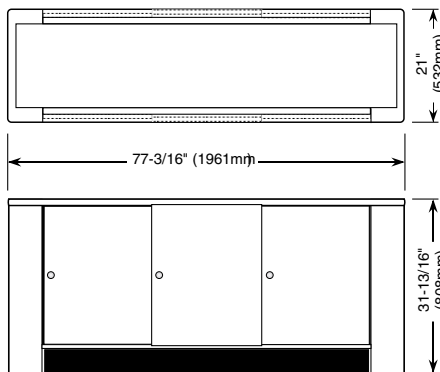

AT NO TIME SHOULD THE COMPARTMENTS, OR THE CABINET EXTERIOR BE STEAMED CLEANED, WASHED DOWN, FLOODED WITH WATER OR LIQUID SOLUTION. DO NOT USE WATER JET TO CLEAN. SEVERE DAMAGE OR ELECTRICAL HAZARD COULD RESULT, VOIDING THE WARRANTY.

UN-23734 RACK

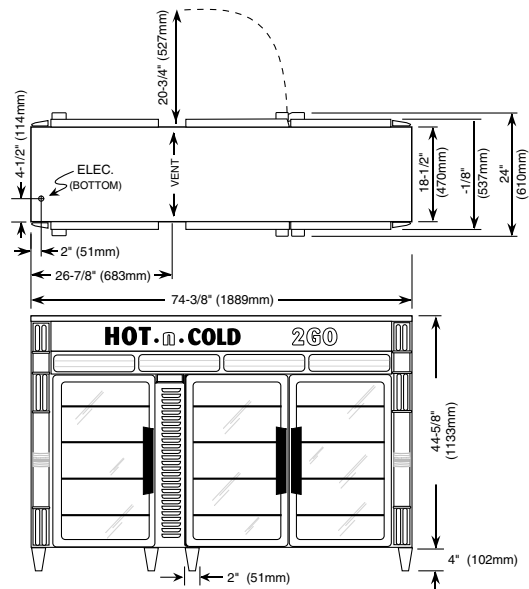
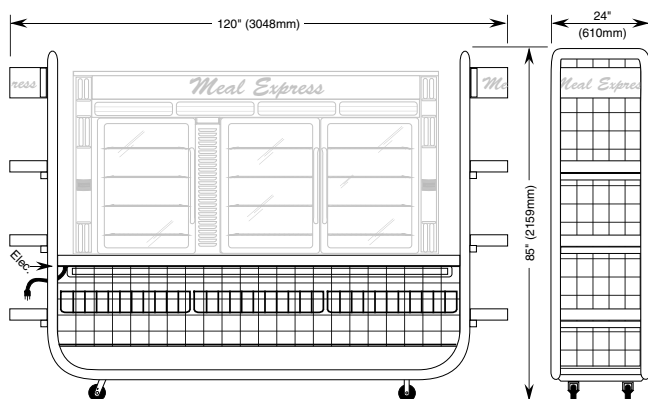

Hot and Cold Merchandiser • Model 1000-HCM

INTERIOR	<ul style="list-style-type: none"> —Four (4) 15 watt fluorescent lamps —Four (4) stainless steel side racks —Eight (8) chrome plated wire shelves spaced at 3-3/8" (87mm) centers
INSIDE DIMENSIONS (W X D X H)	<p>Hot Compartment: 38-1/2" x 18-1/2" x 29" (978mm x 470mm x 737mm)</p> <p>SHELVES: 33" x 17-7/8" (938mm x 454mm)</p> <hr style="border-top: 1px dotted black;"/> <p>Cold Compartment: 17-7/8" x 18-1/2" x 29" (454mm x 470mm x 737mm)</p> <p>SHELVES: 15-7/8" x 17-7/8" (403mm x 454mm)</p>
ELECTRICAL	<p>120/208-240 V.A.C. — 60 Hz, 1 Ph BARE END NO PLUG 3700 Watts, 15.4 Amps</p> <hr style="border-top: 1px dotted black;"/> <p>220 V.A.C. — 50 Hz, 1 Ph BARE END NO PLUG 3520 Watts, 16.0 Amps</p>
NET WEIGHT	610 lb (264 kg)
SHIP WEIGHT	930 lb (366 kg)
OPTIONS & ACCESSORIES	<p>Color Match Side PanelsFACTORY QUOTE</p> <p>Customized Signage</p> <p style="padding-left: 20px;">— 66-1/4" w x 7-1/4" h (1682mm x 184mm)FACTORY QUOTE</p> <p>Meal Express Graphic PackagePE-24012</p> <p>Menu Panel PackageFACTORY QUOTE</p> <p>Stainless Steel Shelves, HOT SECTION (4) . .SH-22817</p> <p>Stainless Steel Shelves, COLD SECTION (2) . .SH-22818</p>

3300-HCM BASE

UN-23734 RACK

EXTERIOR DIMENSIONS (H x W x D)	<p>33-13/16" x 77-1/4" x 21-7/8" (808mm x 1962mm x 556mm)</p>	<p>85" x 120" x 24" (2159mm x 3048mm x 610mm)</p>
ELECTRIC	N/A	120 V.A.C. – 60 Hz, 1 Ph
NET WEIGHT	172 lb (78 kg)	375 lb (228 kg)
SHIP WEIGHT	290 lb (132 kg)	475 lb (295 kg)
OPTION	Color Match PanelsFACTORY QUOTE	Custom GraphicsFACTORY QUOTE



This chart is provided for the assistance of *qualified technicians only* and is not intended for use by untrained or unauthorized service personnel. If your unit is not operating properly, check the following before calling your authorized service agent. Check the power applied to the unit. Plug in outlet? Fuse OK?

Do not attempt to repair or service beyond this point. Contact manufacturer for nearest authorized service agent. Repairs made by any other service agent without prior authorization by manufacturer will void the warranty on the unit.

Trouble Shooting Guide

Error Code	Possible Cause	Action Required
<p>1. Control displays "OOO".</p>	<p>A. Sensor is open circuited.</p> <p>B. Associated wiring is open circuited.</p> <p>C. Control is faulty.</p>	<p>Detach the sensor from the terminal block. Use an Ohm meter to measure the resistance of the sensor. Check sensor at 32°F (0°C) using a container of ice water. If Ohm reading is 100, replace display. If Ohm reading is not 100, replace sensor.</p> <p>Check wires for integrity. Check for proper and secure connections at the thermostat and terminal block. If necessary, re-secure the faulty connections.</p> <p>Energize system after the above steps have been completed. If control still reads "OOO", contact factory.</p>
<p>2. Control displays "CCC".</p>	<p>A. Sensor is short circuited.</p> <p>B. Associated wiring is short circuited.</p> <p>C. Control is faulty.</p>	<p>Detach the sensor from the terminal block. Use an Ohm meter to measure the resistance of the sensor. Check sensor at 32°F (0°C) using a container of ice water. If Ohm reading is 100, replace display. If Ohm reading is not 100, replace sensor.</p> <p>Check wires for integrity. Check for proper and secure connections at the thermostat and terminal block. If necessary, re-secure the faulty connections.</p> <p>Energize system after the above steps have been completed. If control still reads "CCC", contact factory.</p>
<p>3. Unit does not operate.</p>	<p>A. Insufficient power supply.</p> <p>B. Defective power cord or plug.</p>	<p>Check power source.</p> <p>Check and replace if necessary.</p>
<p>4. No display in electronic control.</p>	<p>A. Faulty power supply board.</p> <p>B. Faulty electronic control.</p>	<p>Check line voltage for 24V across pins 6 and 7 on the power supply board.</p> <p>Replace control.</p>
<p>5. Cannot control temperature but sensor and electronic control check OK.</p>	<p>A. Faulty relay.</p> <p>B. Heating element sensor.</p>	<p>Replace relay.</p> <p>Replace element.</p>
<p>6. Temperature readout incorrect.</p>	<p>A. Dirty or faulty sensor.</p> <p>B. Faulty control.</p>	<p>Detach the sensor from the terminal block. Use an Ohm meter to measure the resistance of the sensor. Check sensor at 32°F (0°C) using a container of ice water. If Ohm reading is 100, replace display. If Ohm reading is not 100, replace sensor.</p>

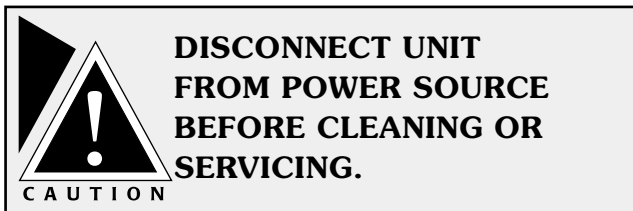

SERVICE VIEW PARTS LIST

4-20-00	QTY PER UNIT	ALTO-SHAAM PART NO.
PART DESCRIPTION		
1. BOTTOM BRACKET	6	BT-23451
2. HANDLE, DOOR	6	HD-23423
3. HOT GASKET	2	GS-22970
4. HOT SHELF	4	SH-22817
5. REFRIGERATOR GASKET	2	GS-22971
6. REFRIGERATOR SHELF	4	SH-22818
7. SKYLIGHT	6	GL-22972
8. TOP BRACKET	6	BT-23452
9. TORQUEMASTER	6	HD-22973
10. TORQUEROD	6	HD-22974
11. PIN-HINGE	6	PI-2894
12. EVAPORATOR COIL	1	RE-22816
13. CAPILLARY TUBING, 6' (1829mm)	1	RE-22815
14. CONDENSING UNIT, 120/208-240	1	RE-22813
CONDENSING UNIT, 220V	1	RE-24013
15. DRIER, CONDENSING UNIT	1	RE-22814
16. LOW PRESSURE CONTROL	1	SW-33091
17. TIMER/DEFROST CLOCK, 60HZ	1	TR-33090
TIMER/DEFROST CLOCK, 50HZ	1	TR-33424
18. EVAPORATOR FAN	1	FA-3861
19. BULB HOLDER (STATIONARY)	4	LP-33094
BULB HOLDER (SPRING)	4	LP-33093
20. BULB, FLOURESCENT	4	LP-33095
21. BALLAST, 120/208-240V	2	LP-33092
BALLAST, 220V	2	LP-33423
22. LEGS, 4" (102mm)	6	LG-2044
23. CORDSET, 120/208-240V, 10' (3048mm)	1	CD-3557
CORDSET, 220V, 10' (3048mm)	1	CD-3304
24. THERMOSTAT, DIGITAL	2	TT-33563
25. SWITCH, 16A, ROCKER	2	SW-3409
26. SWITCH, MAIN POWER	1	SW-3715
27. RELAY	2	RL-3736
28. TRANSFORMER	2	TN-3935
29. THERMOSTAT, ELECTRONIC		TT-33563
30. TERMINAL BLOCK, UPPER		BK-3023
31. SENSOR	2	SN-33541
SENSOR TERMINAL BLOCK		BK-33546
32. PLASTIC DECOR, SIGN ENDS	4	GL-23442
33. MENU BOARD (NOT SHOWN)	1	MB-22976
34. DECOR STRIP ASSEMBLY	1	14047
35. PLEXI HEADER, HOT•N•COLD 2GO	2	GL-22978
36. DOOR ASSEMBLY	6	DR-22979
37. HEATING CABLE, 132' (40234mm) (NOT SHOWN)		CB-3045
38. FUSEHOLDER FOR CONTROL	2	FU-33227
FUSE	4	FU-33070
39. FUSEHOLDER FOR BALLAST	1	FU-33227
FUSE, 120/208-240V	2	FU-33376
FUSE, 220V	2	FU-33422
40. PANEL OVERLAY	1	PE-22622
41. BAFFLE PAN, HOT CAVITY (NOT SHOWN)	1	13536
42. EXTERNAL CONDENSATE DRIP PAN(NOT SHOWN)	1	13561
43. SIDE RACKS. HOT SIDE	2	13528
SIDE RACKS, COLD SIDE	2	13521
44. EVAPORATOR FAN	1	FA-3861

NOTE

**DO NOT USE ABRASIVE CLEANERS
ON THE EXTERIOR OF THE
MERCHANDISER.
USE A NON-ABRASIVE CLEANSER
OR DISTILLED WHITE VINEGAR TO
REMOVE WATER SPOTS
OR OTHER STAINS.**

Cable Replacement Kit

Heating Cable Service Kit No. 4880

includes:

CB-3045 . . . Cable Heating Element 134 feet
CR-3226 . . . Ring Connector 4
IN-3488 . . . Insulation Corner 1 foot
BU-3105 . . . Shoulder Bushing 4
BU-3106 . . . Cup Bushing 4
SL-3063 . . . Insulating Sleeve 4
TA-3540 . . . Electrical Tape 1 roll
ST-2439 . . . Stud, 10-32 4
NU-2215 . . . Hex Nut 8



**Disconnect unit
from power source
before cleaning
or servicing.**

SERVICE VIEWS * Model 1000-HCM

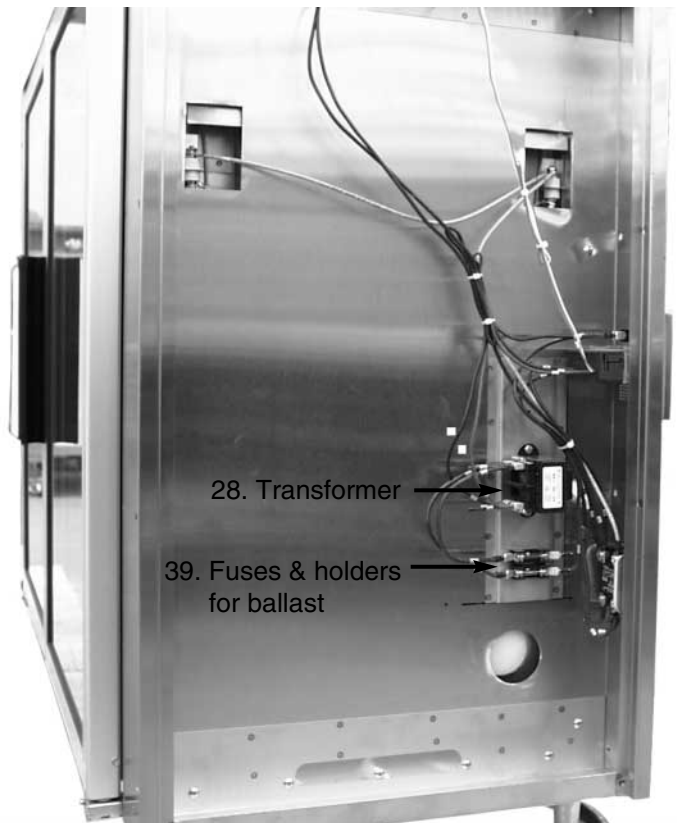

SERVICE VIEWS * Model 1000-HCM

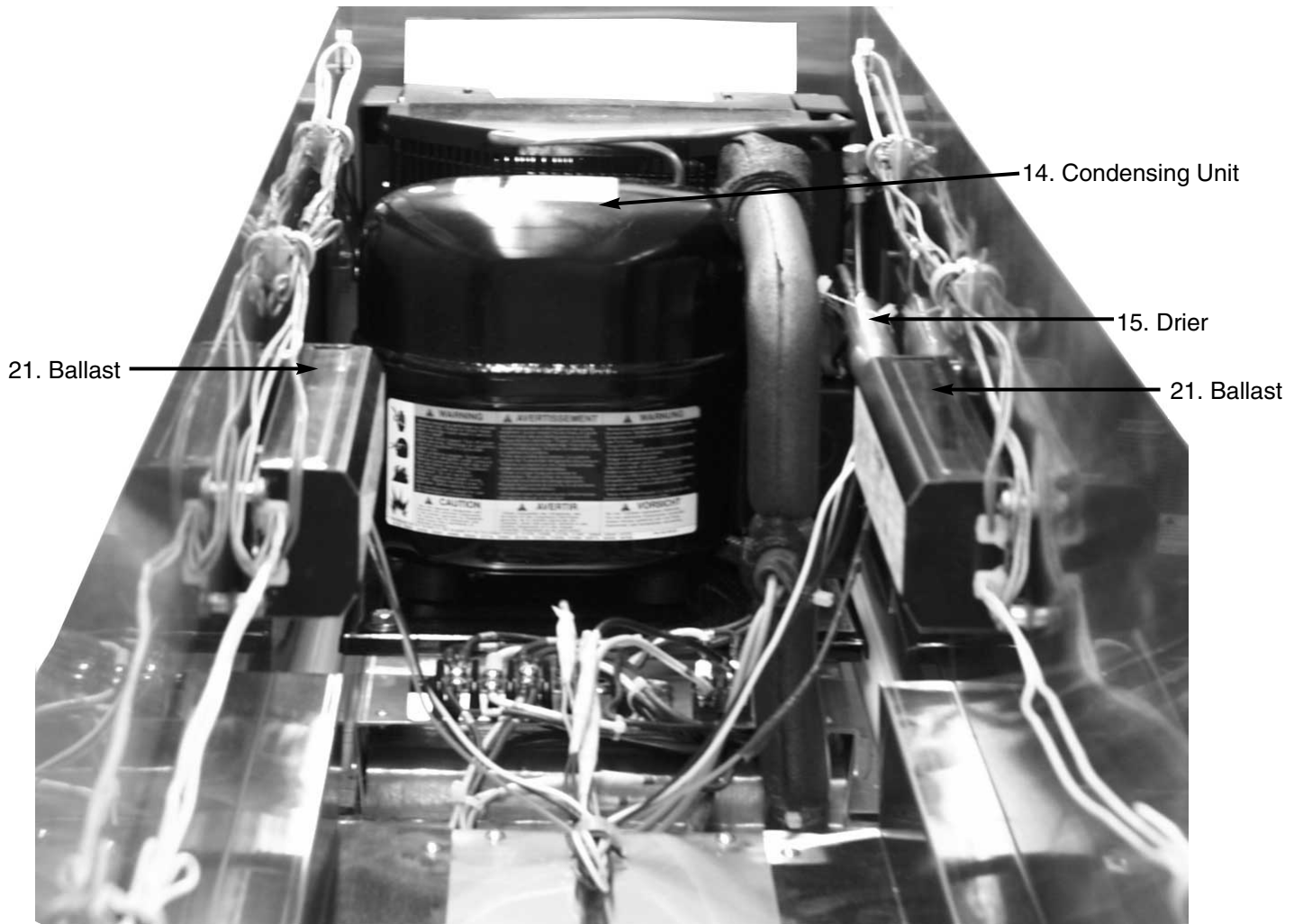

120/208-240V
60HZ
3696W
15.4A

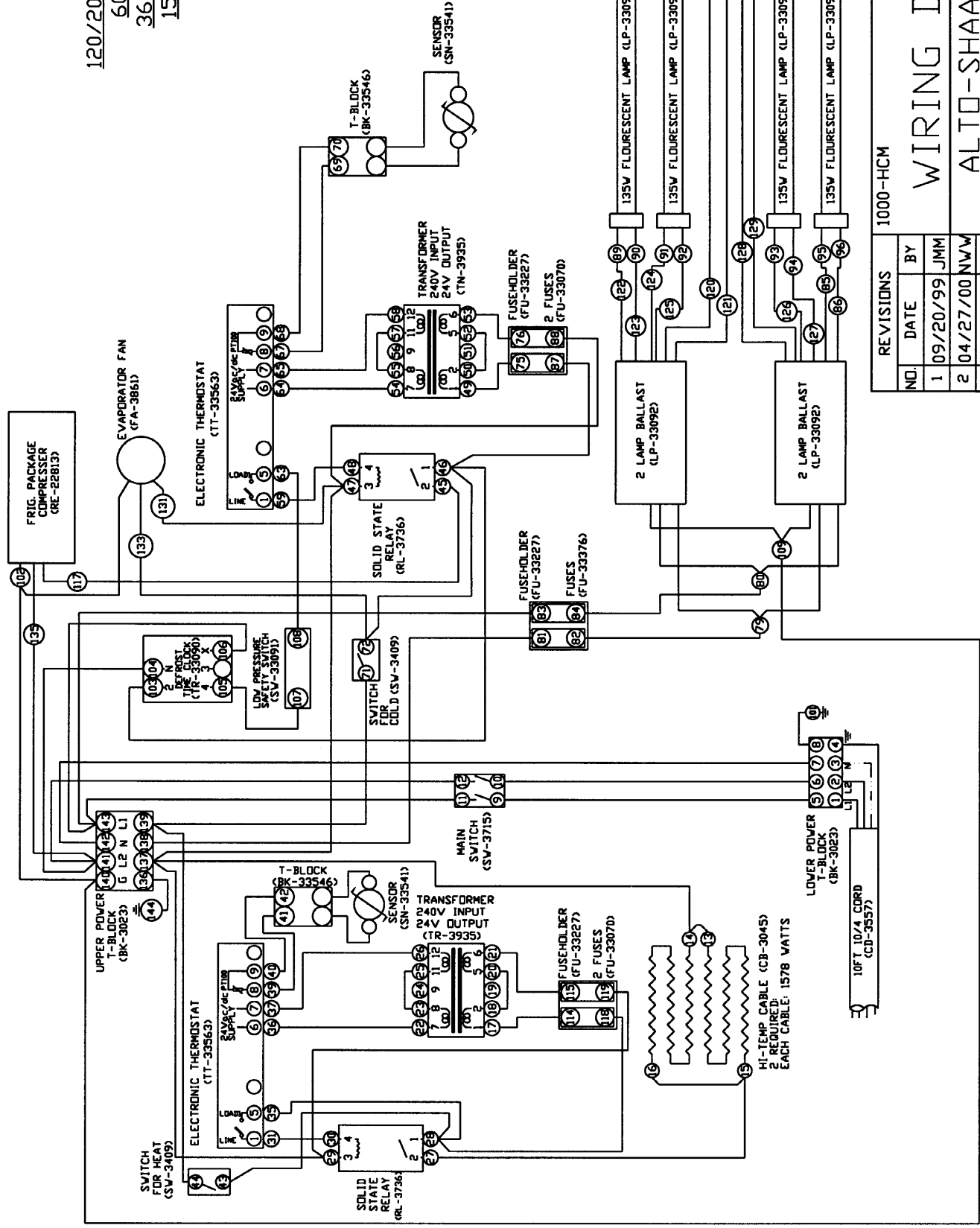

REVISIONS		1000-HCM	120/208-240V, 60HZ
NO.	DATE	BY	
1	09/20/99	JMM	
2	04/27/00	NWW	
3			
4			
5			

WIRING DIAGRAM

ALTO-SHAAM INC.
MENDONNEE FALLS, WISCONSIN

NOTE #1: ALL NUMBERS IN () = ALTO-SHAAM PART NUMBERS.
NOTE #2: SEE DRAWING #C-8842 FOR WIRE ASSEMBLIES.

DRAWN BY	RS	SCALE	NONE	DWG. NO.	
APP'D	MS	DATE	3/03/98		A-7477

220V
50HZ
3520W
16.0A

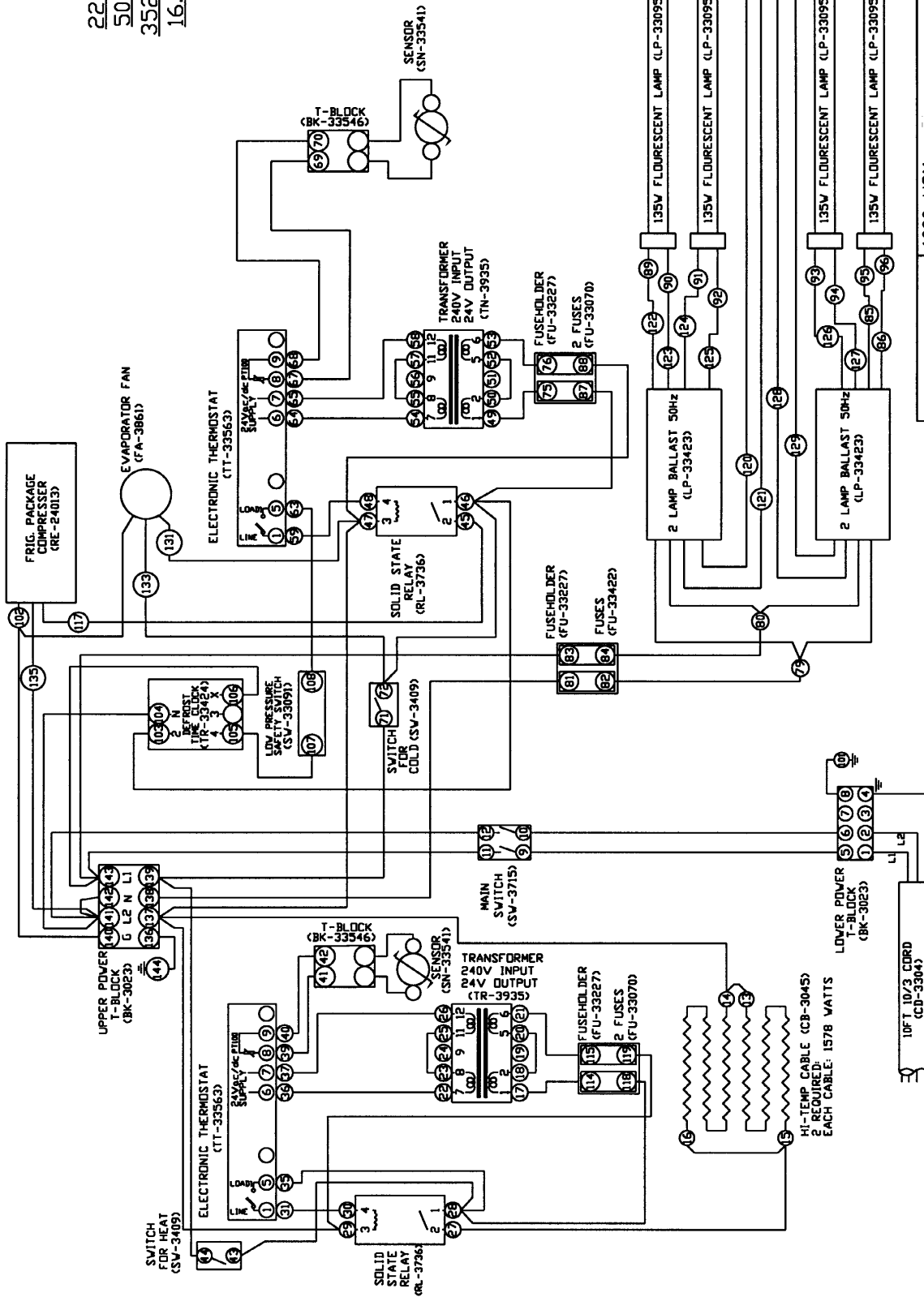

REVISIONS		1000-HCM	
NO.	DATE	BY	
1	09/20/99	JMM	
2	04/27/00	NW	
3			
4			
5			

220V, 50Hz, 1PH
WIRING DIAGRAM
ALTO-SHAAM INC.
MENDOTA FALLS, WISCONSIN

NOTE #1: ALL NUMBERS IN () = ALTO-SHAAM PART NUMBERS.
NOTE #2: SEE DRAWING #C-8843 FOR WIRE ASSEMBLIES.

DRAWN BY RS
SCALE NONE
DATE 3/03/98

APP'D MS
DWG. NO. A-7478

TRANSPORTATION DAMAGE and CLAIMS



All Alto-Shaam equipment is sold F.O.B. shipping point, and when accepted by the carrier, such shipments become the property of the consignee.

Should damage occur in shipment, it is a matter between the carrier and the consignee. In such cases, the carrier is assumed to be responsible for the safe delivery of the merchandise, unless negligence can be established on the part of the shipper.

1. Make an immediate inspection while the equipment is still in the truck or immediately after it is moved to the receiving area. Do not wait until after the material is moved to a storage area.
2. Do not sign a delivery receipt or a freight bill until you have made a proper count and inspection of all merchandise received.
3. Note all damage to packages directly on the carrier's delivery receipt.
4. Make certain the driver signs this receipt. If he refuses to sign, make a notation of this refusal on the receipt.
5. If the driver refuses to allow inspection, write the following on the delivery receipt:
Driver refuses to allow inspection of containers for visible damage.
6. Telephone the carrier's office immediately upon finding damage, and request an inspection. Mail a written confirmation of the time, date, and the person called.
7. Save any packages and packing material for further inspection by the carrier.
8. Promptly file a written claim with the carrier and attach *copies* of all supporting paperwork.

We will continue our policy of assisting our customers in collecting claims which have been properly filed and actively pursued. We cannot, however, file any damage claims for you, assume the responsibility of any claims, or accept deductions in payment for such claims.

ALTO-SHAAM® LIMITED WARRANTY

Alto-Shaam, Inc. warrants to the original purchaser that any original part that is found to be defective in material or workmanship will, at our option, subject to provisions hereinafter stated, be replaced with a new or rebuilt part.

The labor warranty remains in effect one (1) year from installation or fifteen (15) months from the shipping date, whichever occurs first.

The parts warranty remains in effect one (1) year from installation or fifteen (15) months from the shipping date, whichever occurs first.

Exceptions to the one year part warranty period are as listed:

- A. Halo Heat cook/hold ovens include a five (5) year parts warranty on the heating element. Labor will be covered under the terms of the standard warranty period of one (1) year or fifteen (15) months.
- B. Alto-Shaam Quickchillers include a five (5) year parts warranty on the refrigeration compressor. Labor will be covered under the terms of the standard warranty period of one (1) year or fifteen (15) months.

This warranty does not apply to:

1. Calibration
2. Replacement of light bulbs and/or the replacement of display case glass due to damage of any kind.
3. Equipment damage caused by accident, shipping, improper installation or alteration.
4. Equipment used under conditions of abuse, misuse, carelessness or abnormal conditions.
5. Any losses or damage resulting from malfunction, including loss of product or consequential or incidental damages of any kind.
6. Equipment modified in any manner from original model, substitution of parts other than factory authorized parts, removal of any parts including legs, or addition of any parts.

This warranty is exclusive and is in lieu of all other warranties, expressed or implied, including the implied warranties of merchantability and fitness for purpose. In no event shall the Company be liable for loss of use, loss of revenue, or loss of product or profit, or for indirect or consequential damages. This warranty is in lieu of all other warranties expressed or implied and Alto-Shaam, Inc. neither assumes or authorizes any persons to assume for it any other obligation or liability in connection with Alto-Shaam equipment.

ALTO-SHAAM, INC.

Warranty effective January 1, 2000

Record the model and serial numbers of the unit for easy reference.

Always refer to both model and serial numbers in your correspondence regarding the unit.

Model: _____
Serial Number: _____
Purchased From: _____
Date Installed: _____ Voltage: _____

HALO HEAT COOK/HOLD/SERVE SYSTEMS BY ALTO-SHAAM®
W164 N9221 Water Street • P.O. Box 450 • Menomonee Falls, Wisconsin 53052-0450

PHONE: 262.251.3800

FAX: 262.251.7067 - 800.329.8744 U.S.A./CANADA

WEBSITE:

800.558.8744 U.S.A./CANADA

262.251.1907 INTERNATIONAL

www.alto-shaam.com

PRINTED IN U.S.A.