

Remote Filter

MODELS FKF, FKF-H
Service Manual
Serial Numbers 122085 and higher



Fresh ideas in foodservice equipment

BKI LIMITED WARRANTY

2812 Grandview Dr. • Simpsonville, SC 29680 • USA
(864) 963-3471 • Toll Free: (800) 927-6887 • Fax: (864) 963-5316

WHAT IS COVERED

This warranty covers defects in material and workmanship under normal use, and applies only to the original purchaser providing that:

- ☒ The equipment has not been accidentally or intentionally damaged, altered or misused;
- ☒ The equipment is properly installed, adjusted, operated and maintained in accordance with national and local codes, and in accordance with the installation and operating instructions provided with this product.
- ☒ The serial number rating plate affixed to the equipment has not been defaced or removed.

WHO IS COVERED

This warranty is extended to the original purchaser and applies only to equipment purchased for use in the U.S.A.

COVERAGE PERIOD

- ☒ Warranty claims must be received in writing by BKI within one (1) year from date of installation or within one (1) year and three (3) months from date of shipment from the factory, whichever comes first.
- ☒ COB Models: One (1) Year limited parts and labor.
- ☒ COM Models: Two (2) Year limited parts and labor. COM convection ovens also have a two (2) year door warranty.
- ☒ CO1 Models: Two (2) Year limited parts and labor. Five (5) Year limited door warranty.
- ☒ BevLes Products: Two (2) Year limited parts and labor.
- ☒ Warranty period begins the date of dealer invoice to customer or ninety (90) days after shipment date from BKI, whichever comes first.

WARRANTY COVERAGE

This warranty covers on-site labor, parts and reasonable travel time and travel expenses of the authorized service representative up to (100) miles round trip and (2) hours travel time and performed during regular, weekday business hours.

EXCEPTIONS

Any exceptions must be pre-approved in advance and in writing by BKI. The extended door warranty on convection ovens years 3 through 5 is a parts only warranty and does not include labor, travel, mileage or any other charges.

EXCLUSIONS

- ☒ Negligence or acts of God,
- ☒ Thermostat calibrations after (30) days from equipment installation date,
- ☒ Air and gas adjustments,
- ☒ Light bulbs,
- ☒ Glass doors and door adjustments,
- ☒ Fuses,
- ☒ Adjustments to burner flames and cleaning of pilot burners,
- ☒ Tightening of screws or fasteners,
- ☒ Failures caused by erratic voltages or gas suppliers,
- ☒ Unauthorized repair by anyone other than a BKI Factory Authorized Service Center,
- ☒ Damage in shipment,
- ☒ Alteration, misuse or improper installation,
- ☒ Thermostats and safety valves with broken capillary tubes,
- ☒ Freight - other than normal UPS charges,
- ☒ Ordinary wear and tear,
- ☒ Failure to follow installation and/or operating instructions,
- ☒ Events beyond control of the company.

INSTALLATION

Leveling, as well as proper installation and check out of all new equipment - per appropriate installation and use materials – is the responsibility of the dealer or installer, not the manufacturer.

REPLACEMENT PARTS

BKI genuine Factory OEM parts receive a (90) day materials warranty effective from the date of installation by a BKI Factory Authorized Service Center.

Table of Contents

Table of Contents	1
Introduction.....	2
Safety Precautions	2
Safety Signs and Messages	2
Safe Work Practices	3
Safety Labels	5
Operation.....	6
Controls and Indicators	6
BLF/FKM Filtering Procedure.....	6
DNF Filtering Procedure	8
Filter Pad Replacement.....	10
Replacement Parts	11

Introduction

Congratulations! You have chosen an **FKF** Remote Filter that will give you many years of fine service from the original manufacturer, **BKI**. The FKF Remote Filter is designed to filter shortening used in BKI's Electric Pressure Fryer (model BLF and FKM only) and Donut Fryer (model DNF only).

The BKI name and trademark on this unit assures you of the finest in design and engineering -- that it has been built with care and dedication -- using the best materials available. Attention to the operating instructions regarding proper installation, operation, and maintenance will result in long lasting dependability to insure the highest profitable return on your investment.

NOTICE

PLEASE READ THIS ENTIRE MANUAL BEFORE OPERATING THE UNIT. If you have any questions, please contact your BKI Distributor. If they are unable to answer your questions, contact the BKI Technical Service Department, toll free: 1-800-927-6887. Outside the U.S., call 1-864-963-3471.

Safety Precautions

Always follow recommended safety precautions listed in this manual. Below is the safety alert symbol. When you see this symbol on your equipment, be alert to the potential for personal injury or property damage.



Safety Signs and Messages

The following Safety signs and messages are placed in this manual to provide instructions and identify specific areas where potential hazards exist and special precautions should be taken. Know and understand the meaning of these instructions, signs, and messages. Damage to the equipment, death or serious injury to you or other persons may result if these messages are not followed.

⚠ DANGER

This message indicates an imminently hazardous situation which, if not avoided, will result in death or serious injury.

⚠ WARNING

This message indicates a potentially hazardous situation, which, if not avoided, could result in death or serious injury.

⚠ CAUTION

This message indicates a potentially hazardous situation, which, if not avoided, may result in minor or moderate injury. It may also be used to alert against unsafe practices.

NOTICE

This message is used when special information, instructions or identification are required relating to procedures, equipment, tools, capacities and other special data.

Safe Work Practices

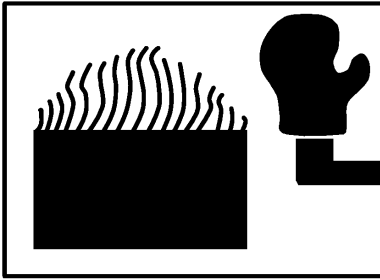

Wear Safe Clothing Appropriate To Your Job

Always wear your insulated mitts when handling the fryer basket or touch any hot metal surfaces. You received a pair of insulated mitts with your fryer. If you lose or damage your mitts, you can buy new ones at your local restaurant equipment supply store or from your local **BKI** Distributor.

Always wear non-skid shoes when working around the fryer or any other equipment that uses shortening. Never wear loose clothing such as neckties or scarves while operating your fryer. Keep loose hair tied back or in a hair net while operating your fryer.

Always wear appropriate personal protection equipment during the filtering process to guard against possible injury from hot oil.

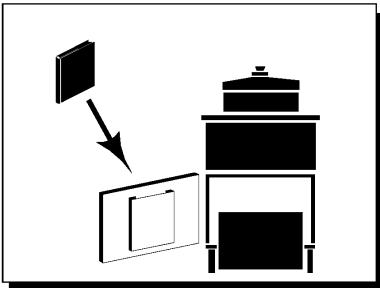

Keep this manual with the Equipment

This manual is an important part of your equipment. Always keep it near for easy access.

If you need to replace this manual, contact:

BKI

Technical Services Department
2812 Grandview Drive
Simpsonville, S.C. 29680

Or call toll free: 1-800-927-6887
Outside the U.S., call 864-963-3471

Or download from our website:
<http://www.bkideas.com/na/service.htm>



Protect Children

Keep children away from this equipment. Children may not understand that this equipment is dangerous for them and others.

NEVER allow children to play near or operate your equipment.

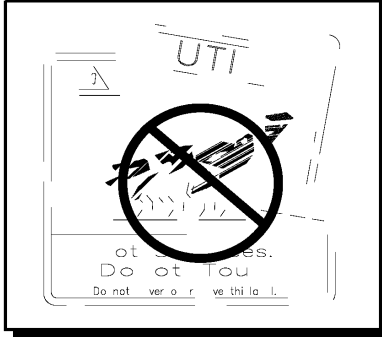

Keep Safety Labels Clean and in Good Condition

Do not remove or cover any safety labels on your equipment. Keep all safety labels clean and in good condition. Replace any damaged or missing safety labels. Refer to the Safety Labels section for illustration and location of safety labels on this unit.

If you need a new safety label, obtain the number of the specific label illustrated on page 5, then contact:

BKI

Technical Services Department
2812 Grandview Drive
Simpsonville, S.C. 29680
Or call toll free: 1-800-927-6887
Outside the U.S., call 864-963-3471

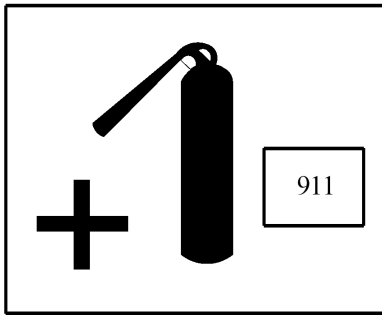

Be Prepared for Emergencies

Be prepared for fires, injuries, or other emergencies.

Keep a first aid kit and a fire extinguisher near the equipment. You must use a 40-pound Type BC fire extinguisher and keep it within 25 feet of your equipment.

Keep emergency numbers for doctors, ambulance services, hospitals, and the fire department near your telephone.

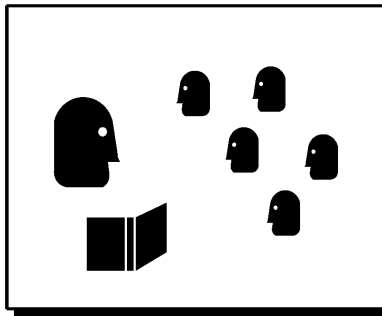

Know your responsibilities as an Employer

- Make certain your employees know how to operate the equipment.
- Make certain your employees are aware of the safety precautions on the equipment and in this manual.
- Make certain that you have thoroughly trained your employees about operating the equipment safely.
- Make certain the equipment is in proper working condition. If you make unauthorized modifications to the equipment, you will reduce the function and safety of the equipment.

Safety Labels

N0352

OPERATING INSTRUCTIONS FOR THE FRY KING FILTERING SYSTEM

NOTICE

FRY KING FILTERS SHOULD BE FILTERED ONCE EVERY THREE LOADS OF FOOD.
FILTER PADS SHOULD BE CHANGED ONCE A DAY.

1. TURN THE THERMOSTAT TO THE OFF POSITION. REMOVE THE FRY BASKET.
2. MAKE CERTAIN THAT THE FILTER PAD IS CLEAN AND NOT TORN.
3. PLUG FILTER CORD INTO THE FRYER'S POWER SUPPLY RECEPTACLE. IMPORTANT: MAKE CERTAIN THAT THE FILTER VAT IS UNDER THE MAIN DRAIN VALVE, AND FILTER SCREEN IS IN PLACE.
4. TO PREVENT EXCESSIVE SPLASHING, OPEN MAIN DRAIN VALVE SLOWLY UNTIL OIL STARTS TO FLOW EVENLY.
5. CLOSE FILTER FLOW VALVE.
6. CONNECT HOSE TO QUICK CONNECT COUPLING BY PRESSING HOSE FITTING INTO COUPLING FIRMLY.
7. POINT NOZZLE AT SLIGHT ANGLE BEHIND HEATING ELEMENTS AND TURN FILTER SWITCH TO ON POSITION.
8. AFTER POT HAS BEEN RINSED, TURN FILTER SWITCH TO OFF AND WIPE OUT POT.
9. AFTER POT IS CLEAN, CALRODS ARE CLEAN, AND ALL RESIDUE HAS BEEN

REMOVED FROM THE POT, CLOSE MAIN DRAIN VALVE, TURN FILTER SWITCH TO ON POSITION, AND PUMP OIL THROUGH THE HOSE INTO THE POT. CONTINUE UNTIL THE FILL MARK HAS BEEN REACHED. TURN FILTER SWITCH TO OFF POSITION. IF THE FILL MARK HAS NOT BEEN REACHED, ADD NEW OIL BACK UNTIL THE PROPER LEVEL HAS BEEN REACHED.

10. REMOVE FILTER HOSE BY DISCONNECTING QUICK CONNECT VALVE. HOLD FILTER HOSE, WITH NOZZLE DOWN, OVER POT TO DRAIN ALL EXCESS OIL FROM HOSE.

TO BEGIN FRYING AGAIN:

11. AFTER FILTERING IS COMPLETED TURN FRY/FILTER SWITCH TO FRY AND SET THERMOSTAT TO DESIRED TEMPERATURE. WHEN THERMOSTAT CYCLES OFF, STIR OIL. WHEN THERMOSTAT CYCLES THE NEXT TIME, BEGIN FRYING.
12. IF NO FURTHER FRYING IS ANTICIPATED, TURN FRY/FILTER SWITCH TO OFF AND CLOSE FRYER LID.

N0313

N0521

⚠ CAUTION

To reduce risk of fire and electric shock, use this appliance to filter only one fryer at a time containing a maximum 70 lbs. (10 gal.) of oil

Do not cover or remove this label. N0521

N0202

⚠ DANGER

HIGH VOLTAGE.

Turn power off before servicing.

May have more than one disconnect switch.

Do not cover or remove label. N0202

N0188

⚠ WARNING

Disconnect filter hose before pressing reset button

Hot oil can resume flowing when reset button is pressed.

Do not cover or remove this label. N0188

N0158

⚠ WARNING

CONNECT ONLY TO APPROVED 3 PRONG GROUNDED CIRCUIT. FAILURE TO DO SO COULD RESULT IN SERIOUS INJURY.

⚠ WARNING

CONNECT ONLY TO APPROVED 3 PRONG GROUNDED CIRCUIT. FAILURE TO DO SO COULD RESULT IN SERIOUS INJURY.

DO NOT COVER OR REMOVE THIS LABEL

N0158

Operation

Controls and Indicators

The FKF and FKF-H have a power switch to turn the pump motor on or off. It also contains a pump motor reset switch. If the motor overheats while filtering, it will automatically shut off. To reactivate the pump motor, wait 15 minutes to allow the motor to cool then press the switch. The FKF-H also has a heater mounted on the pump that melts residual solid shortening within the pump. This heater has a power switch used to turn it on or off.

BLF/FKM Filtering Procedure



Always wear appropriate personal protection equipment during the filtering process to guard against possible injury from hot oil.

1. Set the **FILTER/OFF/FRY** switch on the fryer to **OFF**.
2. Turn the thermostat to the off position and remove the fryer basket.
3. Make certain that the FKF filter unit filter pad is clean and not torn.
4. Position the FKF filter unit under the main drain valve and make sure it's filter screen is in place.
5. If solid shortening has been used and needs to be melted in the pump, follow the instructions below, otherwise skip to the next step:
 - a. Plug the pump heater power cord into the BLF/FKM receptacle.
 - b. Turn the pump heater power switch on.
 - c. Position the **FILTER/OFF/FRY** switch to **FILTER**. The heater will begin to melt the shortening in the pump.
 - d. Wait 30 minutes to ensure all shortening in the pump has melted.
 - e. Position the **FILTER/OFF/FRY** switch to **OFF**.
 - f. Turn the pump heater power switch off.
 - g. Unplug the pump heater power cord from the BLF/FKM receptacle.
6. Plug the FKF pump motor power cord into the BLF/FKM receptacle.
7. Place the pump motor power switch on.
8. Move the DRAIN handle on the fryer slowly to the OPEN position until the shortening starts to flow evenly. This will prevent excessive splashing of hot shortening.
9. When the pot is empty, place the DRAIN handle in the CLOSED position.

To refill the pot through the drain valve, use the steps below:

1. Make certain that the braided hose (located on the drain valve) is connected to it's mating part on the FKF filter unit.

⚠ WARNING

Hot shortening may splash out of the pot causing severe injury when filling the pot if the lid is not closed. To prevent shortening splashes, close the lid before filling.

2. Close the lid to prevent shortening splashes.
3. Position the **FILTER/OFF/FRY** switch to **FILTER** and shortening will automatically pump into the pot.
4. After 1 minute carefully open the lid to check the level of the shortening.
5. Let the filter continue to pump the shortening until the fill mark in the fryer pot is reached or until air starts bubbling through the shortening.
6. As soon as air is seen in the shortening, position the **FILTER/OFF/FRY** switch to **OFF** to prevent shortening degradation and prevent the filter pump and lines from filling up with shortening.
7. Add new shortening if the fill mark has not been reached.
8. Disconnect the braided hose.
9. Remove the FKF unit from under the BLF/FKM fryer and place in a storage location.

To refill the pot through the filter hose, use the steps below:

1. Make certain that the filter hose is connected to it's mating part on the FKF filter unit.
2. Holding the hose by the handle, place hose nozzle inside the pot.

⚠ WARNING

Hot shortening may splash out of the pot causing severe injury when filling the pot if the lid is not held down over the hose nozzle. To prevent shortening splashes, hold the lid down over the hose nozzle.

3. Hold the lid down over the hose nozzle to prevent shortening splashes.
4. Position the **FILTER/OFF/FRY** switch to **FILTER** and shortening will automatically pump into the pot.
5. After 1 minute, hold the hose by the handle and carefully raise the lid to check the level of the shortening.
6. Let the filter continue to pump the shortening until the fill mark in the fryer pot is reached or until air starts bubbling through the shortening.
7. As soon as air is seen in the shortening, position the **FILTER/OFF/FRY** switch to **OFF** to prevent shortening degradation.
8. Add new shortening if the fill mark has not been reached.
9. Disconnect the filter hose. Hold the filter hose, with nozzle down, over the pot to drain all excess oil from the hose.
10. Remove the FKF unit from under the BLF/FKM fryer and place in a storage location.

DNF Filtering Procedure

**WARNING**

Always wear appropriate personal protection equipment during the filtering process to guard against possible injury from hot oil.

1. Set the fryer **POWER** switch to the **ON** position.
2. Set the **FILTER MOTOR** switch on the fryer to **OFF**.
3. Turn the thermostat to the off position and remove the screen lifter.
4. Make certain that the FKF filter unit filter pad is clean and not torn.
5. Position the FKF filter unit under the main drain valve and make sure it's filter screen is in place.
6. If solid shortening has been used and needs to be melted in the pump, follow the instructions below, otherwise skip to the next step:
 - a. Plug the pump heater power cord into the fryer power receptacle.
 - b. Turn the pump heater power switch on.
 - c. Position the **FILTER MOTOR** switch to **ON**. The heater will begin to melt the shortening in the pump.
 - d. Wait 30 minutes to ensure all shortening in the pump has melted.
 - e. Position the **FILTER MOTOR** switch to **OFF**.
 - f. Turn the pump heater power switch off.
 - g. Unplug the pump heater power cord from the fryer power receptacle.
7. Plug the FKF pump motor power cord into the fryer power receptacle.
8. Place the pump motor power switch on.
9. Move the DRAIN handle on the fryer slowly to the OPEN position until the shortening starts to flow evenly. This will prevent excessive splashing of hot shortening.
10. When the pot is empty, place the DRAIN handle in the CLOSED position.
11. Make certain that the filter hose is connected to it's mating part on the FKF filter unit.
12. Holding the hose by the handle, place hose nozzle inside the pot.

**WARNING**

Hot shortening may splash out of the pot causing severe injury when filling the pot if the lid is not held down over the hose nozzle. To prevent shortening splashes, hold the lid down over the hose nozzle.

13. Hold the lid down over the hose nozzle to prevent shortening splashes.
14. Position the **FILTER MOTOR** switch to **ON** and shortening will automatically pump into the pot.

15. After 1 minute, hold the hose by the handle and carefully raise the lid to check the level of the shortening.
16. Let the filter continue to pump the shortening until the fill mark in the fryer pot is reached or until air starts bubbling through the shortening.
17. As soon as air is seen in the shortening, position the **FILTER MOTOR** switch to **OFF** to prevent shortening degradation.
18. Add new shortening if the fill mark has not been reached.
19. Disconnect the filter hose. Hold the filter hose, with nozzle down, over the pot to drain all excess oil from the hose.
20. Remove the FKF unit from under the fryer and place in a storage location.

Filter Pad Replacement

The filter pad must be replaced daily. If the shortening has a milky color when it is pumped into the pot, the filter pad should be replaced immediately.

CAUTION

If the filter pad is not properly closed, breading crumbs will get through the pad opening and clog the pump. Ensure that the filter pad is properly closed upon replacement.

1. Place the filter screen inside the filter pad.
2. Fold the end of the pad and seal with the bag clip.

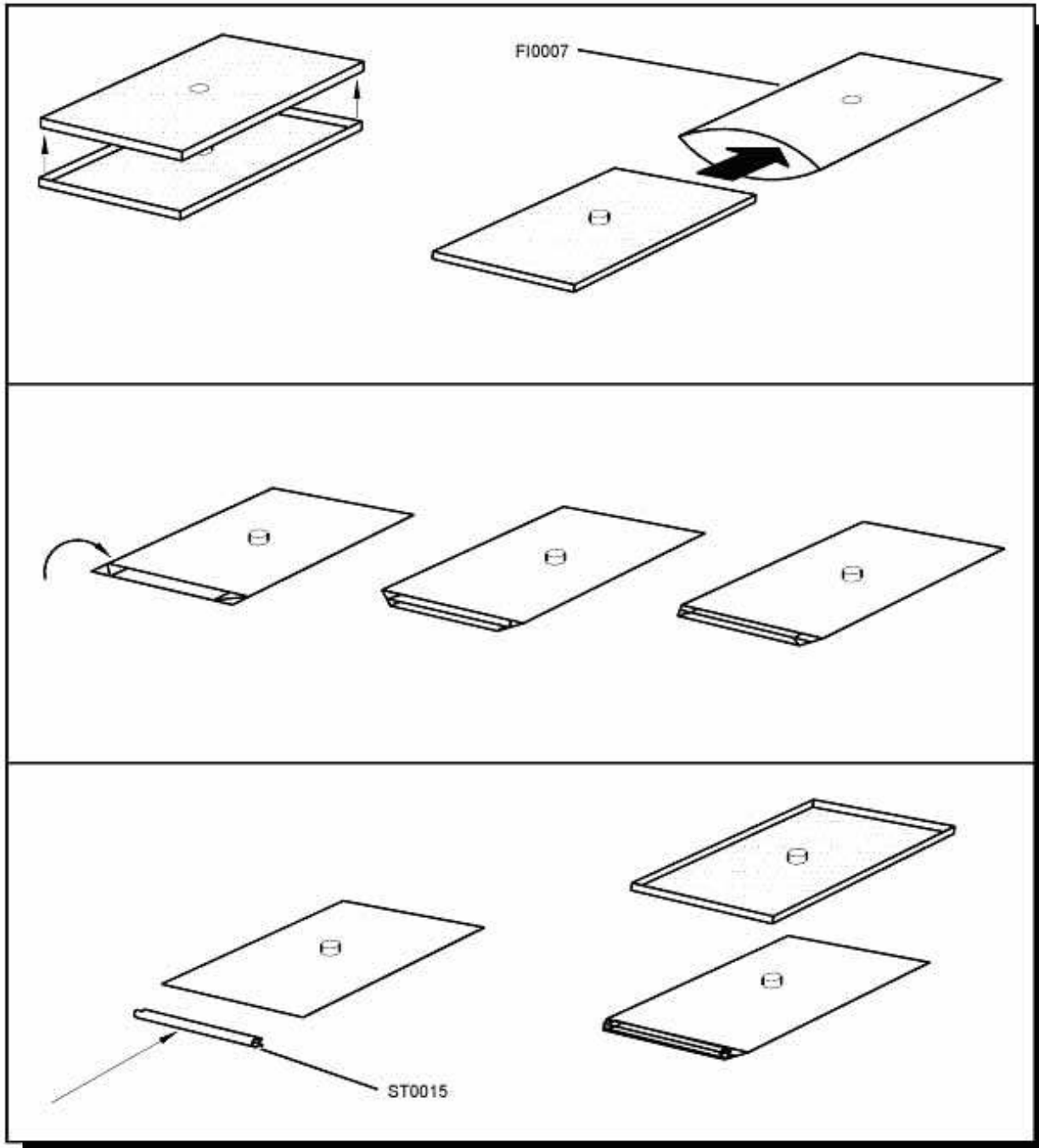

Replacement Parts

Use the information in this section to identify replacement parts. To order replacement parts, call your local BKI sales and service representative. Before calling, please note the serial number, model number and voltage on the rating tag affixed to the unit.

ITEM #	PART #	QTY	DESCRIPTION
1	WFKFA006	1	FKF BASE UNIT WELDMENT
2	C0400	4	CASTER, 121-2R FKF
3	SB2306	1	S/S CRUMB BASKET WELD, FKF
4	SB2307 or SB7704	1	OIL CONTAINER WELD, FKF or OVERSIZE OIL VAT WELD, FKF
5	SB2319	1	FILTER HEATING ASSY, HAIGHT (ACCESSORY)
6	FT0105	1	UNION, 3/8 HANDLE BAR
7	FKFA058	1	TUBING, SCREEN TO UNION FKF
8	FC0003	1	FEMALE COUPLING
9	SB7659	1	FILTER SCREEN FITTING SPOTWELD
10	O0013	1	O-RING, FLUOROCARBON V680-70
11	FS0002	1	FILTER SCREEN, INTERCEPTOR
12	FC0004	1	NUT SCREEN RETAINING FKM-F &
13	FS0001	1	FILTER SCREEN, BOTTOM
14	FS0003	1	FILTER SCREEN, TOP
15	FT0506	2	ELL, 5/8 TUBE TO 1/2NPT FEMALE
16	P0081	1	PLUG, F-H4F4-7-7 QUIK DISCONN
17	FKFA061	1	TUBING, PUMP TO DISCONNECT,FKF
18	B0851	1	BUSHING, BLK HEX REDUCING
19	M0053	1	MOTOR, LEESON LESS CORD/PUMP
20	FI0007	1	FILTER, FKM-F 13.5 X 20.5
21	ST0015	1	FILTER BAG CLIP FKM-F
22	FKFA068	1	MOTOR COVER, FKF
23	FKFA069	1	CORD NEST, FKF
24	S0103	1	SWITCH, RKR DPST 15A 250V LAMP
25	FKFA063	1	SWITCH ENCLOSURE, FKF
26	CS0006	1	CORD SET, 250V 23" BLK FKF
27	FT0195	2	NIPPLE, 1/2 X 2 BLK
28	P0070	1	PUMP ONLY FOR HAIGHT MOTOR
29	FKFA060	1	TUBING, PUMP TO UNION, FKF
30	SB2332	1	FILTER HOSE, FEMALE SOCKET (ACCESSORY)

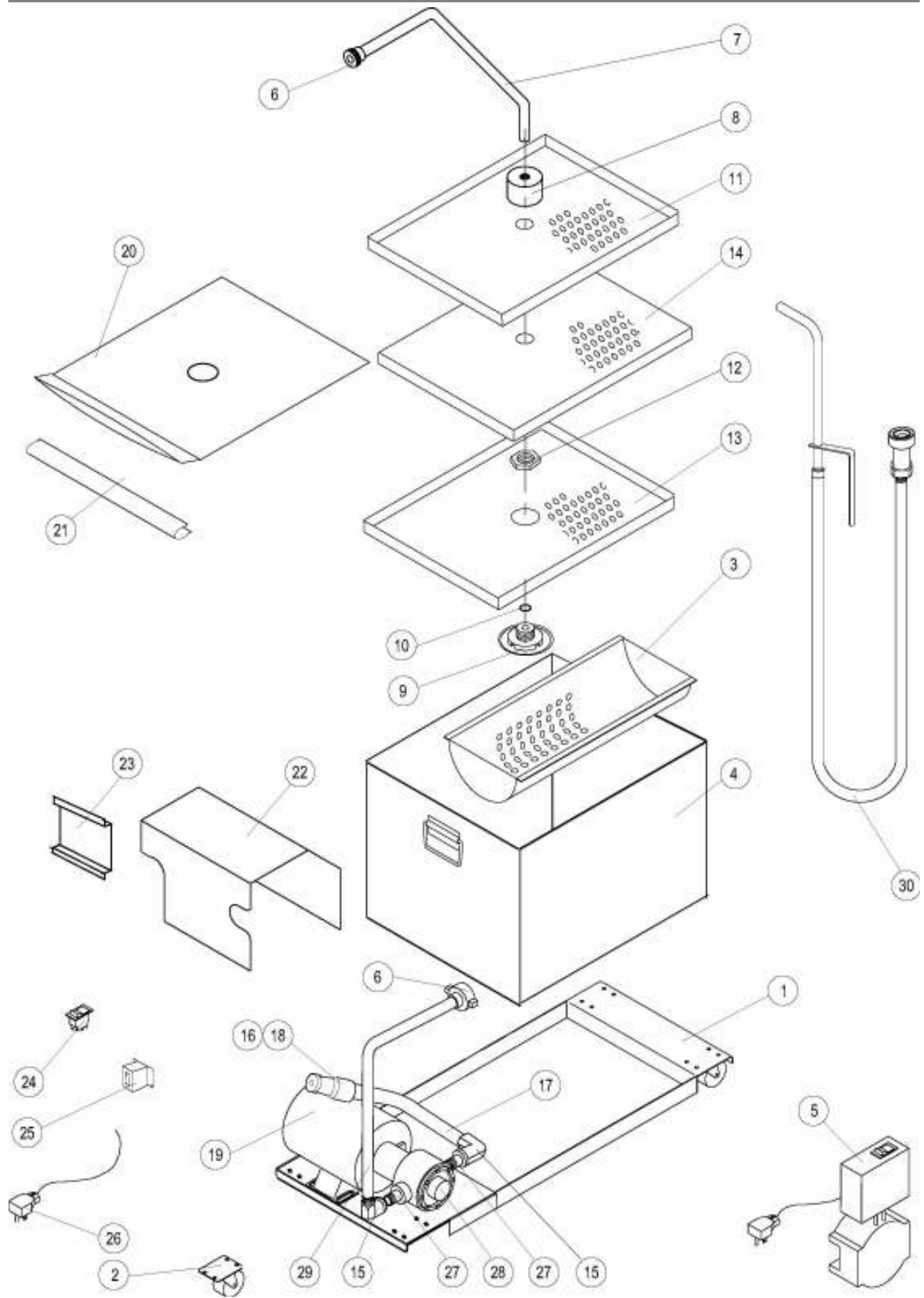



2812 Grandview Dr., Simpsonville, S.C. 29680, USA
<http://www.bkideas.com>

Made and printed in the U.S.A
LI0171/0407

CS-TM-023.01

Revised 3/26/13

REVISION HISTORY

<u>REVISION</u>	<u>DATE</u>	<u>REVISED BY</u>	<u>DESCRIPTION</u>
01	03/26/13	KW	Initial Release-Supersedes all previous releases