

GAS STEAM/CONVECTION AND CONVECTION OVENS

INSTRUCTIONS FOR INSTALLATION AND USE (for the United Kingdom)

Contents

	Page
- Installation diagrams	4
- Appliance identification	31
I. MAIN FEATURES	32
1. Description of appliance	32
2. Table 1: Technical data	33
3. Precautions	34
4. Safeguarding the environment	34
4.1 Packaging	34
4.2 Use	34
4.3 Cleaning	34
4.4 Disposal	34
II. INSTRUCTIONS FOR INSTALLATION	35
1. Place of installation	35
1.1 Reference standards	35
2. Positioning	35
3. Combusted gas discharge	35
3.1 Foreword	35
3.2 Installation of accessories	35
3.3 Warnings regarding the fluing system	35
4. Electrical connection	36
4.1 Installing the power supply cable	36
5. Water mains connection	36
5.1 Water supply characteristics	37
5.2 Water drain system	37
6. Gas connection	38
7. Conversion to a different gas type	38
7.1 Access to components	38
7.2 FITTING THE BURNER-BLOWER FLOW REDUCER (PLATE)	38
7.3 Changing the gas valve diaphragm (nozzle)	38
7.4 Gas valve adjustment	38
7.5 Table 2: Nozzles and adjustments / Gas types	39
7.6 Appliance gas type sticker	40
8. Safety devices	40
9. Operation check	40
10. Servicing	40
11. Troubleshooting	40
12. Layout of main components	40
III. INSTRUCTIONS FOR USE	41
1. Opening the oven door	41
1.1 6- and 10-grid models	41
1.2 20-grid models	41
2. Closing the oven door	41
2.1 6- and 10-grid models	41
2.2 20-grid models	41
3. Description of the control panel	42
3.1 Introduction	42
3.2 Main controls	42
3.3 Main cooking modes	42
3.4 Special cooking modes	42
3.5 Additional functions	42
USING THE OVEN	44
4. Operating level A, B and C	44
4.1 Switching the oven on	44
4.2 Selecting the controls	44
4.3 Manual controls	44
4.4 Automatic controls	48
5. Information and error codes	51
6. Switching off in the event of a fault	52
7. Care and maintenance	52
7.1 Periodic maintenance of the boiler	53
7.2 Replacing consumable components	54
7.3 Special cleaning instructions	54
- CONTROL PANEL FIGURES	295

- APPLIANCE IDENTIFICATION

Identification dataplate

L.C. Made in E.E.C. 51M12

PNC 9PDX 260462 05

2. TABLE 1: TECHNICAL DATA

6GN1/1			
(AOS061E)			
260450-260510	260462	260456	260457
260451-260511	260463	260457	260458
o	o	o	o
**	**	**	**
	230	200	

I. MAIN FEATURES

1. DESCRIPTION OF APPLIANCE

This booklet describes a number of appliance models. For more detailed information about the model in your possession, refer to "**Technical Data**" table 1.

The appliance has the following features:

- Digital temperature indicator.
- Thermostatic probe for measuring the core temperature of products (core temperature probe).
- Continuous monitoring of cooking parameters throughout the entire cooking cycle.
- Periodic draining and automatic washing of the boiler to prevent the build-up of lime-scale (only available on certain models).
- Boiler lime-scale level indicator (see corresponding paragraph)(only available on certain models).

- Oven chamber automatic fast steam drain device for gratins.
- Air-break anti-backup drain device to prevent backflows from the drainage system from entering the oven (only available on certain models).
- Oven chamber lighting.
- Double-action door opening **safety** mechanism designed to protect the user from scalding steam (only available on certain models).
- Double-glazed oven door for reduced heat dispersion into the kitchen and low temperatures on the exterior of the oven.
- Daily oven chamber cleaning cycle (CLEANING SYSTEM) (only available on certain models).
- Self-diagnostics system indicating oven faults using error codes (see "**Information and error codes** ").

For UK and COMMONWEALTH only:

This appliance is designated as a forced draught burner, therefore the appliance is classed as COMCAT5 and only installers who held the relevant gas qualification are allowed to install/commission and service this product.

WARNING:

Failure to use a qualified/authorised installer WILL INVALIDATE THE WARRANTY conditions and may render the appliance inoperative.

If any doubt please consult the manufacturer for further advice.

Under no circumstances must this product be used unless installed and /or commissioned by a qualified engineer.

Noise emission data: Noise emissions generated by the appliances described in this booklet do not exceed 70 dB (A).

★ Your appliance model is indicated in the box marked **PNC** on the Identification dataplate affixed to the bottom left hand side of the oven.

★★ Gas consumption was calculated in the following conditions:

- Temperature 15°C;
- Atmospheric pressure 1013.25 mbar;
- Net calorific value :
 - G30 (Hi=45.65 MJoule/kg)
 - G31 LPG (Hi=46.34 MJoule/kg)
 - G20 natural gas (Hi=34.02 MJoule/m3)
 - G25 natural gas (Hi=29.25 MJoule/m3)
 - LPG (Japan) (Hi=46.34 MJoule/kg)
 - 13A natural gas (Japan) (Hi=34.02 MJoule/m3)

for AUSTRALIA

- Propane Gas (Hi=95.8 MJ/m3)
- Natural Gas (Hi=37.8 MJ/m3)

^ FUNCTIONAL LEVEL (C=Convect, Covection).

2. TABLE 1: TECHNICAL DATA

n° of GRIDS	6 GN 1/1			10 GN 1/1			10 GN 2/1			20 GN 1/1			20 GN 2/1			
PNC *	A ^	267500		267520			267502		267522	267503		267523	267504		267505	
		267510 ^{oo}					267512 ^{oo}			267513 ^{oo}			267514 ^{oo}		267515 ^{oo}	
		237500					237502			237503			237504		237505	
		237510 ^{oo}					237512 ^{oo}			237513 ^{oo}			237514 ^{oo}		237515 ^{oo}	
		647500					647502			647503			647504		647505	
		647510 ^{oo}					647512 ^{oo}			647513 ^{oo}			647514 ^{oo}		647515 ^{oo}	
	268700		268520			268702		268522	268703		268523	268704		268705		
	268780					268782			268783			268784		268785		
	268510 ^{oo}		238720			268512 ^{oo}		238722	268513 ^{oo}		238723	268514 ^{oo}		268515 ^{oo}		
	268700 ^{oo}					268702 ^{oo}			268703 ^{oo}			268704 ^{oo}		268705 ^{oo}		
	238500					238502			238503			238504		238505		
	238700					238702			238703			238704		238705		
	238510 ^{oo}					238512 ^{oo}			238513 ^{oo}			238514 ^{oo}		238515 ^{oo}		
	238710 ^{oo}					238712 ^{oo}			238713 ^{oo}			238714 ^{oo}		238715 ^{oo}		
	648500					648502			648503			648504		648505		
	648510 ^{oo}					648512 ^{oo}			648513 ^{oo}			648514 ^{oo}		648515 ^{oo}		
	648540					648542						648544				
	648570					648572										
		269700				269702			269703			269504		269505		
		269710 ^{oo}				269712 ^{oo}			269713 ^{oo}			269714 ^{oo}		269715 ^{oo}		
		269780				269782						269784		269785		
		269790				269792			269793					269795		
		239500				239502			239503			239504		239505		
		239700				239702			239703			239704		239705		
		239510 ^{oo}				239512 ^{oo}			239513 ^{oo}			239514 ^{oo}		239515 ^{oo}		
		239710 ^{oo}				239712 ^{oo}			239713 ^{oo}			239714 ^{oo}		239715 ^{oo}		
		649500				649502			649503			649504		649505		
	649510 ^{oo}				649512 ^{oo}			249513 ^{oo}			249514 ^{oo}		649515 ^{oo}			
	649540				649542						649544					
	649570				649572											
CONVECTOR ° BOILER **	o	o	x			o	o	x	o	o	x	o	o		o	o
POWER SUPPLY VOLTAGE (VOLT)	230 1 ~	230 1 ~	100 1 ~			230 1 ~	230 1 ~	100 1 ~	230 1 ~	230 1 ~	100 1 ~	230 1 ~	230 1 ~		230 1 ~	230 1 ~
FREQUENCY (Hz)	50 / 60	50 / 60	50 / 60			50 / 60	50 / 60	50 / 60	50 / 60	50 / 60	50 / 60	50 / 60	50 / 60		50 / 60	50 / 60
Electrical power draw (Kw)	0,25	0,25	0,41			0,3	0,3	0,46	1	1	1	0,5	0,5		2	2
Power supply cable cross section (mm ²)	3x1,5	3x1,5	3x1,5			3x1,5	3x1,5	3x1,5	3x1,5	3x1,5	3x1,5	3x1,5	3x1,5		3x1,5	3x1,5
ISO 7/1 gas connection Diameter	1/2" M	1/2" M	1/2" M			1/2" M	1/2" M	1/2" M	1/2" M	1/2" M	1/2" M	1" M	1" M		1" M	1" M
Nominal heat output (Kw)	17	10	17			35	20	35	45	27	45	58	40		95	55
Boiler unit nominal heat output (Kw)	10		10			20		20	25		25	25			55	
Convactor unit nominal heat output (Kw)	10	10	10			20	20	20	27	27	27	40	40		55	55
Gas category	II2H3P	II2H3P	II2H3P			II2H3P	II2H3P	II2H3P	II2H3P	II2H3P	II2H3B/P	II2H3P	II2H3P		II2H3P	II2H3P
Construction type	A3 B13	A3 B13	A3 B13			A3 B13	A3 B13	A3 B13	A3 B13	A3 B13	A3 B13	A3 B13	A3 B13	A3 B13	A3 B13	A3 B13
Diagram of fumes discharge system	1a-1b-1c					1a-1b-1c			1a-1b-1c			1a-1b-1c			1a-1b-1c	
G20 natural gas supply pressure - (mbar)	20	20				20	20				20	20			20	20
G25 natural gas supply pressure - (mbar)																
L.P.G. G31 supply pressure (mbar)	30	30				30	30				30	30			30	30
Consumption (kg/h)G30 **	1,34	1,34				2,76	2,76		3,55	3,55		4,57	4,57		7,49	7,49
Consumption (kg/h)G31 L.P.G. **	1,32 ^{oo}	1,32 ^{oo}				2,72 ^{oo}	2,72		3,5 ^{oo}	3,5		4,5 ^{oo}	4,5		7,38	7,38
Consumption (m3/h) G20 natural gas **	1,8	1,8				3,7	3,7		4,76	4,76		6,14	6,14		10,1	10,1
Consumption (m3/h) G25 natural gas **																
Maximum oven load (kg)	30	30	30			50	50	50	100	100	100	100	100		200	200

for Japan

13A natural gas supply pressure - (mbar)			13						13			13				
L.P.G. supply pressure (mbar)			25						25			25				
Consumption (kg/h) L.P.G. **			1,32 ^{oo}					2,72 ^{oo}				3,49 ^{oo}				
Consumption (m3/h) 13A natural gas **			1,33					2,73				3,52				

for AUSTRALIA

PHASES (No)	1+N	1+N					1+N	1+N					1+N	1+N			1+N	1+N
BS/P connection Ø	1/2" M	1/2" M					1/2" M	1/2" M					1/2" M	1/2" M			1/2" M	1/2" M
Natural Gas test point pressure - (KPa)	1	1					1	1					1	1			1	1
Propane Gas test point pressure (KPa)	2.75	2.75					2.75	2.75					2.75	2.75			2.75	2.75
Propane Gas consumption (MJ/h) **	30.6	30.6					30.6	30.6					30.6	30.6			30.6	30.6
Natural Gas consumption (MJ/h) **	30.6	30.6					30.6	30.6					30.6	30.6			30.6	30.6

3. PRECAUTIONS

• Before installing or using the appliance read this instruction booklet carefully because it contains important information concerning safety, operation and maintenance.



• Keep this instruction booklet in a safe place for future consultation by other users or purchasers in the event that the appliance is resold.

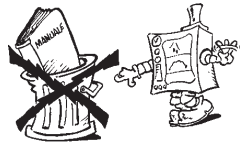

Important: Installation and maintenance of the appliance and its conversion to a different gas supply must only be performed by a qualified installer authorised by the manufacturer.

- This appliance is intended for collective use and is expressly designed for cooking food. Any other use is deemed improper. **The appliance must only be used by trained staff.**
- This appliance is not intended for use by people (including children) with limited physical, sensory or mental abilities or without experience and knowledge of it, unless they are supervised or instructed in its use by a person responsible for their safety.
- Switch off the appliance if it breaks down or malfunctions.
- **Only contact the technical service centre authorised by the manufacturer for repairs and only use original spare parts. Failure to comply with the above requirement may jeopardise the safety of the appliance and invalidate the guarantee.**
- Do not wash the appliance with water jets.



- Do not use products containing chlorine (bleach, hydrochloric acid etc.) even diluted, to clean steel surfaces.
- Do not use corrosive substances (e.g. muriatic acid) to clean the floor under the appliance.
- For more information, refer to the section on "Care and maintenance".

4. SAFEGUARDING THE ENVIRONMENT

4.1 PACKAGING

• All the packaging materials used are environmentally friendly. They may be stored at no risk or burnt at an authorised incineration plant. Plastic materials suitable for recycling are marked with the following symbols:



polyethylene : external wrapping film, instructions booklet bag and gas injectors bag



polypropylene: top packaging panels and straps



expanded polystyrene: protective surround elements

4.2 USE

• The appliance has been designed and perfected under laboratory testing conditions to offer exceptional levels of performance. However, to minimise energy consumption (electricity, gas and water), do not leave the appliance in operation for long periods without food in the oven chamber and avoid conditions that reduce efficiency (e.g. door open). We also recommend preheating the appliance immediately prior to use.

4.3 CLEANING

• To minimise the emission of pollutants into the environment, clean the appliance (externally and, where necessary, internally) with products that are at least 90% biodegradable.

4.4 DISPOSAL

- The appliance must be disposed of properly at the end of its service life.
- The appliance is made from more than 90% recyclable materials (stainless steel, iron, aluminium, galvanised sheet steel, etc.). These materials may therefore be scrapped in accordance with local waste disposal regulations at a conventional recycling plant.
- Make the appliance unusable by cutting off the power cord. Also remove any compartment or interior closure device fitted on the appliance to prevent persons from becoming trapped inside.

The symbol on the product indicates that this product should not be treated as domestic waste, but must be correctly disposed of in order to prevent possible negative consequences for the environment and the human health.

Regarding the recycling of this product, please contact the sales agent or dealer of your product, your after-sales service or the appropriate waste disposal service.

for AUSTRALIA

• Warnings:

- Do not store or use gasoline or other flammable vapours, liquids or items in the vicinity of this or any other appliance.
- Do not spray aerosols in the vicinity of this appliance while it is in operation.
- Never check for leaks with an open flame
- The appliance is not suitable for a marine environment.

II. INSTRUCTIONS FOR INSTALLATION

Important: The oven outer panels must be removed to perform the operations described in this chapter. Since the appliance must be switched on to make certain adjustments, exercise the utmost care when working in the vicinity of live electrical parts.

1. PLACE OF INSTALLATION

• The appliance must only be installed in adequately ventilated premises.

1.1 REFERENCE STANDARDS

• Install the appliance according to the prescriptions of current safety standards.

for AUSTRALIA

• This appliance shall be installed only by authorised persons and in accordance with the manufacturer's installation instructions, local gas fitting regulations, municipal building codes, electrical wiring regulations, local water supply regulations, AS5601-gas installation, health authorities and any other statutory regulations.

2. POSITIONING

- Unpack the appliance and carefully remove the protective film from the outer panels to avoid leaving any trace of adhesive. Use a suitable solvent to remove any adhesive residues.
- **Dispose of the packaging as instructed in the chapter on "Safeguarding the environment"**
- Refer to the installation diagrams at the beginning of this booklet for the space requirements and connection dimensions of the appliance.
- Clearance of approximately **50 cm** must be left between the appliance's left side panel and adjacent structures in order to provide space for maintenance operations when needed; the right side panel and the rear panel of the appliance must be at least **10 cm** from adjacent structures.
- Place the appliance in the required position and adjust the height of the work surface using the adjustable feet.
- The appliance is not suitable for built-in installation.

Important:

Make sure steam from the oven's drain or adjacent appliances does not enter the aeration vents under the appliance, designed to cool internal components located at the bottom of the appliance.

3. COMBUSTED GAS DISCHARGE

3.1 FOREWORD

In relation to the combustion technology utilised, gas fired steam/convection ovens are classified in accordance with their "**Construction Type**". For each of these types of appliances applicable regulations stipulate a specific type of combusted gas discharge system.

Consequently, before installing the discharge system:

a) identify the "**Construction type**" of your model in **Table 1** (technical data) or by checking the appliance identification dataplate;

b) choose the diagram with the type of construction among those shown below, depending on how you intend to exhaust the appliance fumes from the place of installation (e.g. discharge under extraction hood, direct to the outside, or in a central flue).

3.2 WARNINGS REGARDING THE FLUING SYSTEM

Before installation check, on the basis of the contents of the reference standard, to ensure that the volume aspirated by the fumes exhausting system is greater than the volume of combusted gas produced by the appliance (see point 1.1).

If the solution of combusted gas discharge under an extractor hood is chosen, observe the distance (shown in the figure) between the top of the discharge pipe and the lowest point of the hood filters. This distance is defined on the basis of discharge pipe diameter "D".

In the case of discharge direction to the outside or into a central flue (Fig. "1c"), the discharge ducts must NOT present an overall length in excess of 3 metres, must NOT have any reductions in diameter, and must be subjected to periodic inspection and, when necessary, cleaning.

Warning: Since combusted gas (see figure) can reach very high temperatures, check the heat resistant properties of extension ducts if fitted and the filters in the extractor hood to ensure the materials are compatible with the temperature conditions. In addition, periodically check the condition of the filters which, if excessively fouled with fat and dirt, will reduce the efficiency of the suction system and may catch fire.

3.3 INSTALLATION OF ACCESSORIES

Accessories can be easily installed by following the figures below together with the relative key.

The screw holes for fixing accessories "A" and "F" are 3.5 mm in diameter and they must be drilled in-situ on the oven cover in correspondence with the punch marks.

4. ELECTRICAL CONNECTION

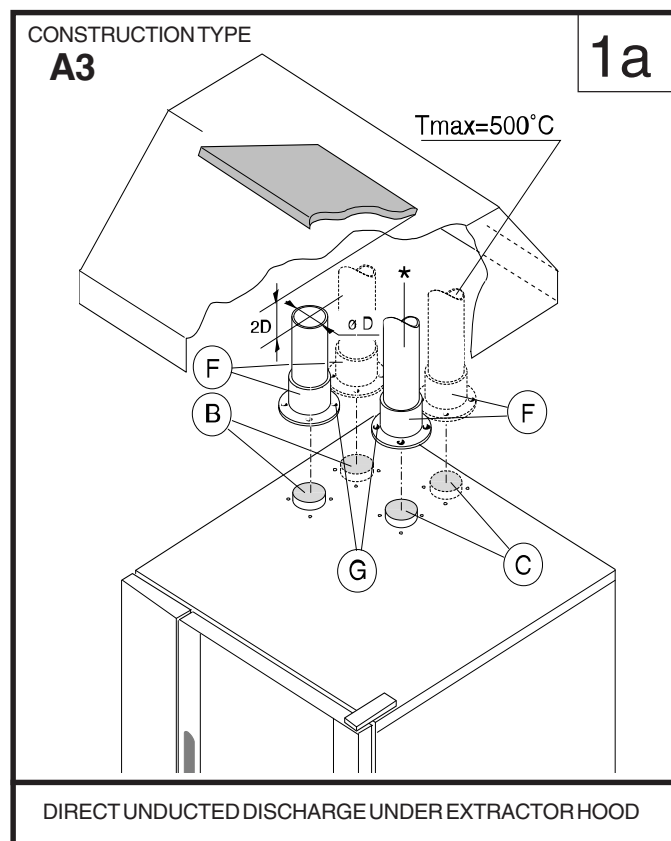

LEGENDA:

- A:** Cam / draught damper accessory (to be ordered from manufacturer)
B: Boiler combusted gas discharge
C: Oven chamber convector combusted gas discharge
E: Adapter ring for commercial ducts (to be ordered from manufacturer)
F: Conical connections for single outlet (supplied) **(always install)**
G: Fixing screws (supplied);
 *: Commercial extension pipes (not supplied)

SILICONE:

Apply silicone sealant between contact surfaces

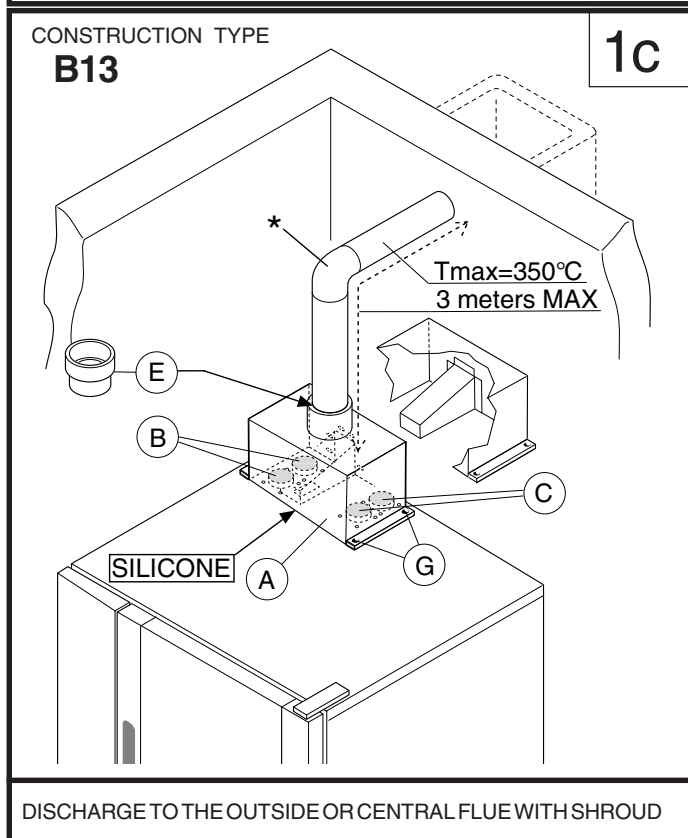
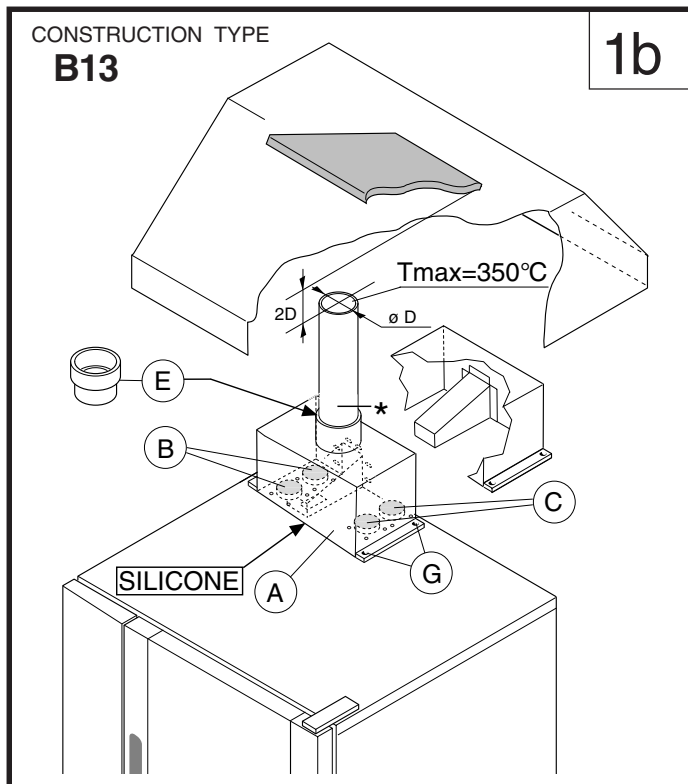

The appliance must be connected to the mains power supply in compliance with current regulations.

- Before connecting the appliance to the mains supply, make sure that the voltage and frequency shown on the appliance identification dataplate correspond with those of the power supply.
- The appliance must be permanently connected to the mains

LEGENDA:

- A:** Cam / draught damper accessory
(to be ordered from manufacturer)
- B:** Boiler combusted gas discharge
- C:** Oven chamber convector combusted gas discharge
- E:** Adapter ring for commercial ducts
(to be ordered from manufacturer)
- F:** Conical connections for single outlet (supplied)
(always install)
- G:** Fixing screws (supplied);
- ***: Commercial extension pipes (not supplied)

SILICONE:

Apply silicone sealant between contact surfaces

power supply with an H05 RN-F type cable. The power supply cable must be protected by a metal or rigid plastic conduit. If the appliance is connected by way of an existing lead, do not insert the cable conduit into the appliance and make particularly sure that the conduit has no sharp edges.

- The appliance must be suitably earthed. The earthing conductor must therefore be connected to the terminal marked \perp on the connection terminal board. The appliance must also be connected to an earth bonding system.

This connection is made using the stop screw marked ∇ located on the outside of the appliance near the power cable inlet. The bonding wire must have a minimum cross-section of 10 mm².

4.1 INSTALLING THE POWER SUPPLY CABLE

To access the power supply cable connection terminal board, proceed as follows:

Model 6 - 10 - 20 GN

- Remove the left side panel.
- Connect the power supply cable to the terminal board according to the instructions given in the wiring diagram and fasten the power supply cable by means of the cable clamp.

The manufacturer declines all responsibility if the applicable safety regulations are disregarded.

5. WATER MAINS CONNECTION

(Refer to the installation diagrams at the beginning of this booklet).

When connecting the appliance to the water system with flexible tubes they must be new and not used.

The appliance is fitted with two separate water inlets ("B" and "N"). The water lines supplying both inlets must be fitted with a mechanical filter and shut-off cock.

Before fitting the filters allow the water to flow out for sufficient time to flush any solid particles from the piping.

Pressure between 150 and 450 kPa (1.5-4.5 bar).

WATER INLET "N"

Attention (water inlet N)

If the supply pipes provided with the appliance are not long enough for installation, use longer ones with **int. diameter at least $\phi 20$ mm** and free of elbow unions.

Note:

To check correct water installation, make sure the rotating wash arm (CLEANING SYSTEM) does not turn below 100 rpm (120 max).

5.1 WATER SUPPLY CHARACTERISTICS

The appliance must be supplied with **drinking water** having specific characteristics given in this section.

HARDNESS FILTER

Water inlet	Appl.	Hardness		
		°f	ppm	°dH
B	A ^	0,5 - 5	5 - 50	0,28 - 2,8
	B ^	0,5 - 5	5 - 50	0,28 - 2,8
	C ^	max 5	max 50	max 2,8
N	A ^	max 5	max 50	max 2,8
	B ^	max 40	max 400	max 22
	C ^	max 5	max 50	max 2,8

^ OPERATING LEVEL (C = Convect, Convection).

The **hardness values** given in the table are for reducing scaling inside the steam generator and possible cooking compartment washing system.

If the available water does not have these hardness characteristics a water softener must be installed.

Therefore the Automatic Water Softener with automatic regeneration for installing on the inlet line, can be requested as an accessory; it has a Resin Sterilizer kit (also by request).

HARDNESS AND CHLORIDE FILTERS

The **chloride concentration (Cl-) (ppm - mg/l)** values with **pH (>7)** and **Conductivity ($\mu\text{S/cm}$)** (measured at 20°C) must be such as to not damage the steel structures inside the oven (only water inlet B).

Therefore the characteristics of the available water must be identified in the graph given at the end of this handbook (page 299), if necessary installing at the inlet the type of filter indicated in the relevant area of the values.

The filters indicated are:

- No filter for chloride (Cl-) in the conforming area (Normal)
- Nanofilter
as an accessory on request, called Water Filter.
- Osmotizer.

Make sure the water coming out the filter is inside the optimum area (Normal).

These filters also have the function of reducing the water hardness to optimum values (below 5°f), and therefore also act as a water softener.

ATTENTION: Periodical checking according to the filter manufacturer's instructions is important to maintain its efficiency and avoid the risk of corrosion in the appliance.

Level C ovens are convection ovens. If water having characteristics outside those specified is used to create humidity inside the oven, there will be the risk corrosion of the compartment and that present inside it.

Carry out regular maintenance of the water softeners and filters to ensure their optimum efficiency.

To avoid damage to the appliance, after every periodical regeneration do a filter cleaning cycle without introducing water in the oven.

The manufacturer declines any liability in case of incorrect maintenance.

Important:

The use of dosing systems designed to prevent the build-up of lime-scale in pipes (i.e. polyphosphate dosing systems) is prohibited since such systems may impair the performance of the appliance.

For UK and COMMONWEALTH only:

In accordance with "the water supply (Water Fittings) Regulations 1999", it is mandatory that this appliance when installed to the mains water supply has fitted an approved "double check valve" connected upstream of the appliance. Failure to comply with these regulations may lead to the appliance being disconnected.

5.2 WATER DRAIN SYSTEM

- OVEN level A -

The oven is supplied with an air-break system to prevent any backflow from the drainage system from reaching the oven's internal circuits and the cooking chamber. The presence of this system means that the drain pipe can be connected directly to the mains drainage system or routed to a floor gully with grating. The flexible drainage hose or rigid pipe can be directed to the side or rear of the appliance if the oven is not positioned against a wall; this line must not be directed towards the front of the appliance to prevent interference with roll-in grid racks. The drainage pipe internal diameter must be no smaller than the oven drain outlet (1" 1/4), **no longer than 1 metre** and must resist temperatures of up to at least 100°C. Avoid restrictions in the case of flexible hose pipes, do not fit elbows on metal pipes anywhere along the drainage line. Also avoid horizontal sections in which water might collect (minimum gradient 5%).

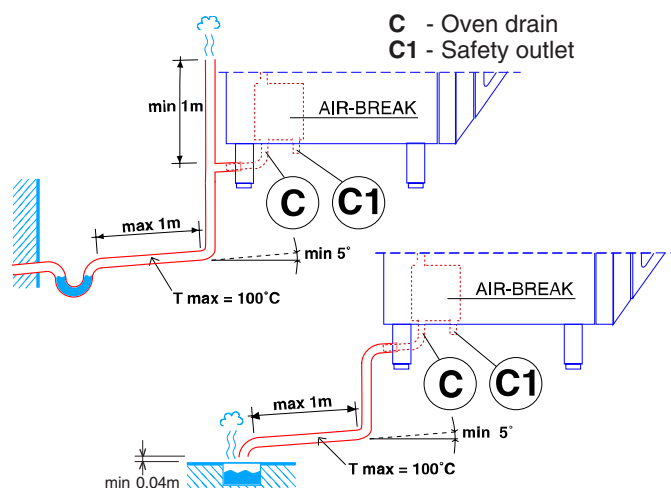

Important:

- Do not obstruct the safety outlet C1.
- Do not connect the safety outlet C1 to the drainage system.

Note:

If water comes out of the AIR-BREAK (safety outlet C1) this means the drain C is blocked. Any elimination of the obstruction **must be carried out by specialised technical personnel**.

- OVEN level B and C -

Connect drain fitting "C" to a drain pipe of the same diameter which is between 0.5 and 3 metres in length and is resistant to temperatures of at least 100°C. The drain pipe must be siphoned (height 80 mm) to an open drain "O" ("Air-Break") or floor grating (see Fig. 12b) in order to prevent any back-flow from the sewage system from reaching the piping inside the oven or oven chamber. Check the hoses and elbows on metal pipes for kinks or pinching along the entire drain line and make sure the drain line has a minimum gradient of 5° to prevent water from collecting inside the system.

Important: The drain system must be installed so that any vapours from the open drain do not enter the aeration vents under the appliance.

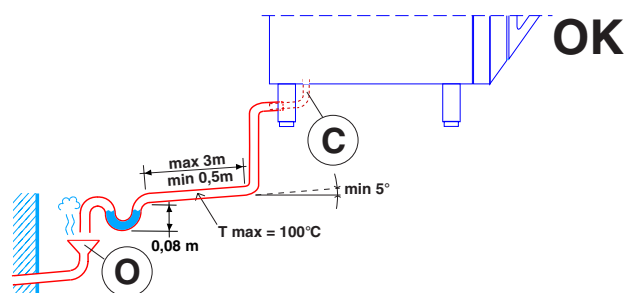

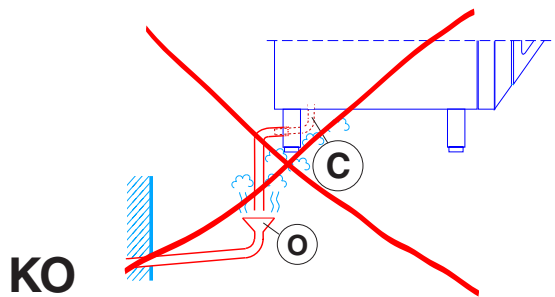

KO

6. GAS CONNECTION

6.1 WARNINGS

- Make sure the appliance is set up for the type of gas with which it will be supplied, if it is not, follow the instructions in chapter 7 "Conversion to a different gas type".
- The gas inlet connector is yellow in colour.
- Before installing consult your local gas utility company to check the compatibility between the available supply and the consumption of the appliance.
- Before hooking up the appliance to the gas pipeline remove the plastic protective plug from the gas connector.
- Fit a rapid gas shut-off cock upline from the appliance in an easily accessible position.
- On completion of installation, use soapy water to check gas connections for leaks.
- It is not possible to adjust the combustion air ventilation capacity.
- If the appliance is hooked up to a supply with a different gas type with respect to the factory setting, after making the necessary changes check that it is working correctly (see heading 8 "Operation Check").

6.2 NOMINAL HEAT OUTPUT

For data concerning the nominal heat output refer to "Technical Data" in Table 1.

This parameter is determined by the pressure of the gas supply and the diameter of the gas valve diaphragm (nozzle).

The appliance nominal heat output must always be checked (by the authorised installer or by the gas utility company), both in the case of new installations and conversion to a different gas type or following maintenance work.

It is strictly prohibited to make changes to the nominal heat output.

6.3 CHECKING THE SUPPLY PRESSURE (Fig. 2a)

The gas supply pressure must be measured upline from the gas shut-off cock with the appliance operating (following conversion operations in the event of a different type of gas supply), using a pressure gauge with minimum resolution of 0.1 mbar and proceeding as outlined below:

- 1) Remove the left hand side panel to gain access to the gas valve;
- 2) Loosen sealing screw "C" from the gas valve pressure test point and connect the pressure gauge hose in its place;
- 3) Open the gas shut-off cock;
- 4) Start a mixed cooking cycle (see "Instructions for use") in such a way that all the burners can be lit;
- 5) Check that the pressure reading is within the values given in the following table:

GAS TYPE

PRESSURE (MBAR)

	Nom.	Min.	Max.
G20 natural gas	20	17	25
G31 L.P.G.	37	25	45
for Japan			
G20 natural gas	13	10	25
G31 L.P.G.	25	20	33

for AUSTRALIA

Natural gas
L.P.G.

PRESSURE (KPa)

Nom.	Min.	Max.
1	-	-
2.75	-	-

If the values are not within the values shown in the table the appliance will not function.

In this case inform your gas utility company of the problem;

6) Once you have measured the supply pressure stop the cooking cycle and close the gas shut-off cock.

7) Disconnect the pressure gauge and carefully refit and tighten sealing screw "C";

8) Refit the previously removed side panel.

7. CONVERSION TO A DIFFERENT GAS TYPE

Warning: Conversion to a different type of gas the appliance is factory set for a specific gas type as specified on the stickers affixed to the packing and to the appliance. To convert the appliance for use with a different gas type adhere strictly to the procedure outlined below.

7.1 ACCESS TO COMPONENTS

- Remove the appliance left hand side panel.

7.2 REPLACING THE BURNER-BLOWER REDUCER (PLATE)

(Fig. 2b)

The reducer (plate) must be replaced for gas G30 and G31 (LPG) only in some models as specified in the TABLE 2 (following pages). The diameter of the middle hole of the reducer is given in mm.

- Unscrew the 2 nuts "F" fixing plate "L" to burner "H".
- Unscrew the 4 nuts "F" fixing blower "G" to burner "H".
- Replace plate "L" (including the 2 gaskets "M") with the plate for gas G30 and G31 (LPG)
- Insert the 2 pins "L1" of plate "L" in the 2 slots "H1" and retighten the 2 nuts "P" (with corresponding washers).
- Retighten the 4 nuts "F" (with corresponding washers).

7.3 REPLACEMENT OF THE GAS VALVE DIAPHRAGM (NOZZLE) (Fig. 2a)

• Unscrew the hex nut of connector "A" with the relative seal "A1" and replace diaphragm "B" (nozzle) with the specific component in relation to the type of gas to be used for relative burner (convector or boiler) and the model of oven in question (see Table 2 - following pages). The diaphragm (nozzle) diameter shown in hundredths of a millimetre is marked on the body of the diaphragm (e.g. diameter 3.5 mm, marking: 350)

- Fully tighten connecting hex nut "A" with the relative seal "A1".
- Repeat the above operations for the other valves (if present) and proceed with the indications specified in the next heading.

7.3.1 PARAMETER ADJUSTMENT

- Change the electronic card parameters relevant to the burner fan control as indicated in the SERVICE MANUAL (not supplied).

7.4 GAS VALVE ADJUSTMENT (Fig. 2a)

Note: the adjustments described below must be performed exclusively by a technician authorised by the manufacturer.

To adjust the pressure (negative) of the gas valve, adapting it to a different type of gas with respect to the factory set type, proceed as follows:

7.5 TABLE 2: NOZZLES AND ADJUSTMENTS / GAS TYPES

FIGURE		2a - 2b																			
n° of GRIDS		6 GN1/1				10 GN1/1				10 GN2/1				20 GN1/1				20 GN2/1			
CONVECTOR ° BOILER **		°		**		°		**		°		**		°		**		°		**	
REFERENCE		∅	#	∅	#	∅	#	∅	#	∅	#	∅	#	∅	#	∅	#	∅	#	∅	#
Diaphragm (nozzle) gas valve Heading 7.3	G30	5,25	525	4,75	475	5,5	550	5,8	580	5,8	580	5,8	580	5,5	550	5,8	580	5,8	580	6	600
	G31 L.P.G. Popane Ga&U)	5,5	550	5	500	5,7	570	6,15	615	6,25	625	6,15	615	5,7	570	6,15	615	6,25	625	6,25	625
	G20 - 13 A Naua Ga&U)	6	600	6	600	7	700	7,5	750	7,8	780	7,5	750	7	700	7,5	750	7,8	780	7,5	750
	G25 naturalgas	6,75	675	6,75	675	8	800	8,5	850	8,5	850	9	900	8	800	9	900	9,25	925	9	900
REPLACING °° burner-blower reducer (plate) Heading 7.2	G30 Popane Ga&U)	12		12		18		18°		18°		18°		18		18°		18°		21	
	G31 L.P.G. Popane Ga&U)	12		12		18		18°		18°		18°		18		18°		18°		21	
	G20 - 13 A Naua Ga&U)	12		12		18		21		21		21		18		21		21		21	
	G25 naturalgas	12		12		18		21		21		21		18		21		21		21	
Ventilator * (ring) burner	G30 G31 L.P.G. Popane Ga&U)	F		F		R		G		G		G		R		G		G		G	
	G20 - 13 A Naua Ga&U)	F		F		R		G		G		G		R		G		G		G	
	G25 naturalgas	F		F		R		G		G		G		R		G		G		G	
Adjustment pressure (negative) gas valve (Pa) Heading 7.4	G30	0 / -10		0		0		0 / -10		0		0 / -10		0		0 / -10		0		0	
	G31 L.P.G. Popane Ga&U)	0 / -10		0		0		0 / -10		0		0 / -10		0		0 / -10		0		^ 0	
	G20 - 13 A Naua Ga&U)	0		0		0		0		0 / -20		0		0		0		0		^ 0 / -20	
	G25 naturalgas	0 / -10		0 / -10		0		0		0		0 / -10		0		0 / -10		0		v 0 / -10	

∅ = diameter (mm)
= punch marking
^ (up) = upper burner gas valve
v (down) = lower burner gas valve
F (Fuchsia)
R (Red)
G (Green)

* Air ventilator (coloured ring) "N" (fig. 2b) of the fan blower must **not** be changed; the colours indicated in the table are for checking purposes only.

(AU) = AUSTRALIA

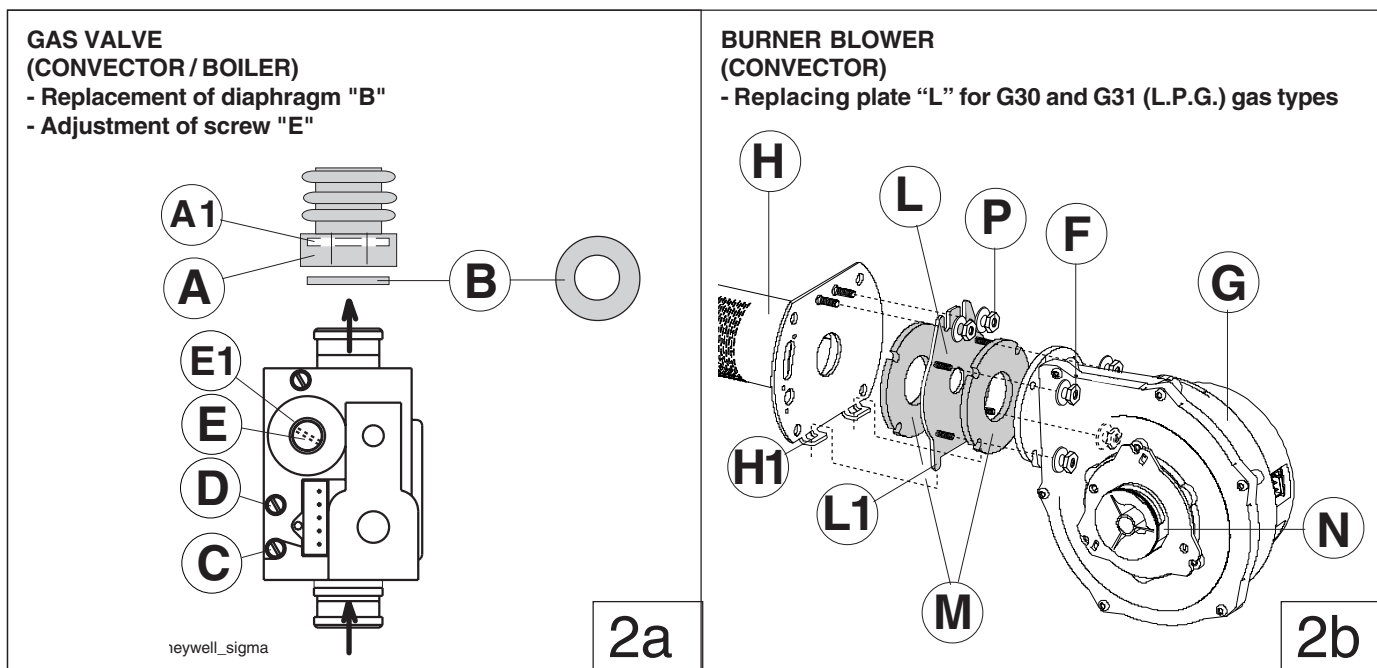

- Loosen the sealing screw "D" in the gas valve pressure test point and connect a **pressure gauge with minimum resolution of 1 Pa**;
- Remove adjuster screw cap "E1".
- Light the burner and select on the control panel a HOT AIR cooking cycle for the convector and a STEAM cycle for the boiler (See "Instructions for use").
- 1 minute after lighting the burner use a suitable tool to adjust screw "E" of the gas valve to regulate the pressure (**negative**) until the pressure gauge reading is aligned with the value shown in TABLE 2 (following pages) corresponding to the burner in question. Wait for a few minutes and (if the value changes) adjust screw "E" again.
- When the adjustment is concluded refit cap "E1" and seal it with red paint, taking care not to clog the vent holes in the valve.
- Turn off the burner.
- Repeat the above procedure for the other valves (if present).

Caution:
When the conversion procedures are concluded refit the oven outer panels

7.6 APPLIANCE GAS TYPE STICKER

After setting up the appliance for a different type of gas, use the sticker relative to the type of gas to be used and affix it to the outside of the oven in a clearly visible position. Choose the required sticker from those available in the supplied pouch.

8. SAFETY DEVICES

The appliance is fitted with the following safety devices:

- **Fuses** (see electrical circuit diagram) located behind the control panel.
To change a fuse unscrew and remove the retainer cap and replace the blown fuse with an identically rated component; the fuse rating value is specified on the relative dataplate.
- **Oven chamber safety thermostat** with manual reset, located behind the control panel; when this device trips, convection heating power is disconnected.
- **Boiler safety thermostat** manual reset type thermostat located behind the control panel, trips to shut off the gas supply to the boiler burner.

The thermostat must be reset exclusively by specialised technical personnel after the cause of the trip has been eliminated.

- Automatic reset **thermal protection** inside the **fan unit**: this device trips in the event of overheating of the fan motor; this cut-out protects the appliance by disconnecting the power supply.

9. OPERATION CHECK

- Switch on the appliance in accordance with the following section "Instructions for use".
- With the aid of the Instruction Booklet, explain operation, routine maintenance, and cleaning to the user.

Important:
- Exercise due care since certain areas of the oven exterior become hot during use.
- Do not cover the exhaust outlets on top of the appliance.

- With oven hot, check the correct working of the door closing mechanism. If necessary, adjust closing by adjusting the position of the catch.

10. SERVICING

All components requiring routine maintenance may be easily reached by opening the control panel, removing the left side panel, or removing the rear panel.

11. TROUBLESHOOTING

Malfunctions may occur even when the appliance is used correctly.

Burner fails to light (message "burn" appears on display TM, see "Instructions for use" chapter 5).

Possible causes:

- The ignition electrode is incorrectly positioned or the insulation is damaged.
- The ignition / flame control device is damaged.
- The ignition electrode high tension lead is broken or shorting to ground.
- Insufficient gas pressure.
- Faulty gas valve.
- Burner fan unit damaged, insufficient air pressure in combustion chamber.
- Electronic control panel is damaged.
- Blown fuse, check electrical diagram.
- Oven chamber temperature probe damaged (error EPt1 - see "Instructions for use" chapter 5).
- Temperature limiter trip.
- High room air humidity (condensation): ventilate the kitchen.

Burner flame extinguishes (message "burn" appears on display TM, see "Instructions for use" chapter 5).

Possible causes:

- Power supply polarity (Phase/Neutral) inverted.
- Electrical supply to oven is "Phase/Phase" type. In this case fit the special "Transformer Kit" available from the manufacturer on request.
- Faulty gas valve.
- Flame detector electrode incorrectly positioned or in open circuit.
- Burner fan unit damaged (lockout situation).
- Flame control device damaged
- High room air humidity (condensation): ventilate the kitchen.

Oven chamber temperature thermostat control is incorrect.

Possible causes:

- Electronic control panel faulty.
- Oven chamber temperature probe is dirty, faulty, or interrupted, see error EPt1 (see "Instructions for use" chapter 5).

Oven fails to turn on. Possible causes:

- Electronic control panel is damaged.
- Fuse F2 blown due to damaged control circuit components.

Oven chamber lamps damaged

CAUTION: Before changing oven chamber lamps switch off the appliance.

12. LAYOUT OF MAIN COMPONENTS

(All work inside the appliance must be carried out exclusively by a trained installer authorised by the manufacturer)

Removing the control panel provides access to the following components:

- Electronic circuit boards
- Oven chamber temperature limit thermostat
- Fuses
- Door microswitch
- Oven chamber lamp transformer
- Geared motor for the oven chamber pressure relief butterfly valve.

Remove the appliance left hand side panel to gain access to all the other components.

III. INSTRUCTIONS FOR USE

Before switching on the appliance, read this instruction booklet carefully because it contains important information concerning correct use of the appliance. If you require further information about the oven's features and cooking performance, consult your local dealer.

- Do not place pans or utensils on top of the oven to avoid obstructing the fumes and steam exhaust outlets.
- Do not insert objects (eg, trays) below the bottom of the oven so as not to obstruct the holes of entry or exit of cooling air.
- Periodically (at least once a year) the appliance should undergo a general inspection. For this purpose we recommend taking out a service contract.
- The core temperature probe is a precision instrument and must be handled with care. Avoid knocks, do not apply excessive force when inserting the probe, and do not pull on the lead (take care particularly when using roll-in racks). **The guarantee does not cover damage to the temperature probe caused by improper use.**
- When using the **mixed** cooking cycle, do not exceed cooking temperatures of 200-210°C. Higher temperatures might impair the performance of the oven chamber seals.
- When placing food in the oven leave a gap of at least 40 mm between each pan to facilitate circulation of hot air.
- If the oven is installed near appliances that produce greasy fumes (e.g. fryer), make sure to use the **air filter** (not supplied), to be placed under the **control panel**, to protect the internal electronic components.
- During **preheating** of the oven 20 GN 1/1 or 2/1, insert the trolley (without food) to close the bottom opening between the compartment and door. This prevents steam from coming out and into the control panel with consequent damage to the electronic board.

• **Do not add salt to foods when inside the oven chamber, particularly during cooking cycles with humidification.**

• **Do not cook with flammable liquids such as alcoholic spirits.**

The maximum height at which the trays are placed in the oven must not exceed 1.6 m. This applies if installed according to the instructions and using original accessories (except for stacked ovens). In case of stacked ovens or in any other case when the above distance is exceeded, the following sticker (supplied) must be placed on the front of the oven in a visible position at a height of 1.6 m from the floor.



ATTENTION: To avoid burns, do not use recipients containing liquids (or products that become liquid with cooking) on levels that are not easily visible. This is to prevent spilling during handling.

1. OPENING THE OVEN DOOR

1.1 6- AND 10-GRID MODELS

Important! Risk of burns.

Open the door with due care when the appliance is hot.

- a) Turn the door handle all the way in either direction (indifferently) to fully open the oven door.
If there is a cooking program in progress it will be interrupted.

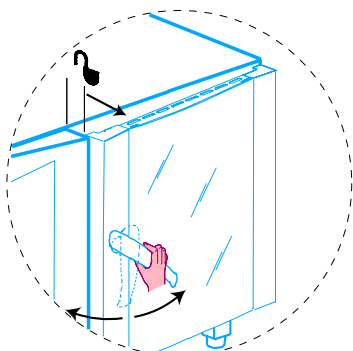

MODELS with SAFETY SYSTEM (by request)

The oven is equipped with a **safety system** to protect the user against scalding steam when the door is opened wide. Proceed as follows:

- a) Turn the oven door handle clockwise as far as it will go. The door opens slightly and is arrested by the **door safety device**.
If there is a cooking program in progress it will be interrupted.

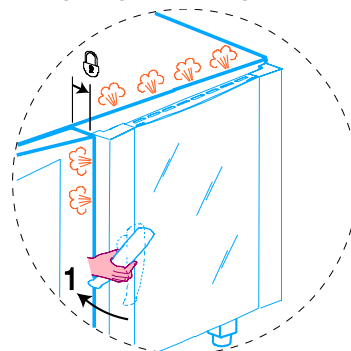

- b) Turn the handle all the way counter-clockwise to open the oven door fully.

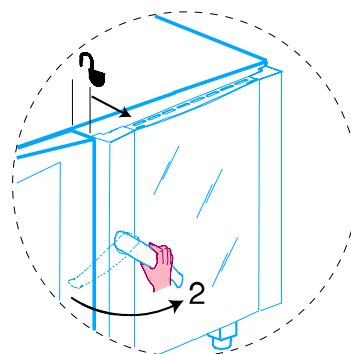

1.2 20-GRID MODELS

Important! Risk of burns.

Open the door with due care when the appliance is hot.

- a) Turn the handle 90° anticlockwise to open the door fully. If there is a cooking program in progress it will be interrupted.

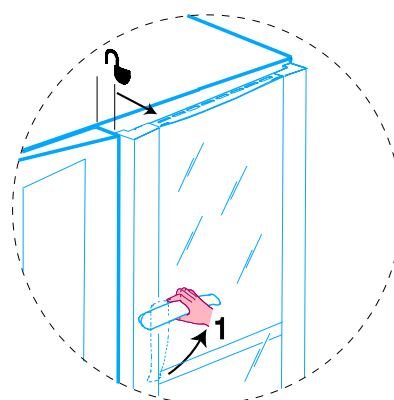

2. CLOSING THE OVEN DOOR

2.1 6- AND 10-GRID MODELS

To close the oven door press it until it locks.

2.2 20-GRID MODELS

- a) Turn the door handle anticlockwise as far as it will go and press the door closed against the oven.
b) Keeping the door pressed closed, lock it by turning the handle to the vertical position.

3. DESCRIPTION OF THE CONTROL PANEL

3.1 INTRODUCTION

To aid understanding of the operation of the oven, find the folding double page showing the control panel for your model among those included at the back of this handbook and then open it out and keep it open while reading this section.

The following headings describe all the functions available on the various models in the range.

Some functions are shared by all models, others are available on specific models.

3.2 MAIN CONTROLS

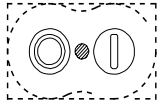

Main switch



Cooking cycle/program start/stop.

3.3 MAIN COOKING MODES



Air-convection cycle: To roast and gratin with a maximum temperature of 300°C.



Mixed cycle: superheated steam. Uses the oven chamber heaters and steam generation system at the same time to keep food soft (maximum temperature 250°C).



Steaming cycle: ideal for steam cooking (operating temperature automatically set at 100°C).

You can set **low temperature steam** for gentle cooking of foods in vacuum packs and for thawing (temperature from 25°C to 99°); **superheated steam**(temperature from 101°C to 130°).

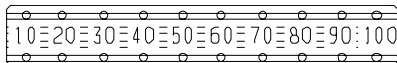

Displaying the humidity value: allows you to display the humidity level of the **air-convection, mixed and regeneration** cycles.



Digital thermometer/thermostat: to control the temperature in the oven chamber.

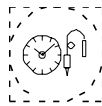

Timer to control cooking time.

Digital thermometer/thermostat: to control product core temperature.

3.4 SPECIAL COOKING MODES



Utilities

Functions useful for the type of cooking to be executed.



Pause phase: set a time in this mode to delay the start of cooking programs or to set a pause interval between two cooking cycles (e.g. for dough proving).



Regeneration cycle: gives ideal humidity conditions for rapid heating of products to be regenerated (maximum temperature 300°C).

The regeneration program is composed of a single phase with the following characteristics:

- a special cycle with controlled humidity of 20 % (adjustable if required);
- a preset temperature value of 120°C (adjustable if required);
- use of full power;
- a **preset time of 30 minutes** (adjustable if required) **and once started, remains active with door open or closed.**

Important! Risk of burns.
Open the door with due care when the appliance is hot.

Alternatively to the set cooking time it can also accept **Cont** cooking time or the core probe.



Cook and hold cycle: for long slow cooking, typically for meat (large joints).

It can be used in combination with **convection, mixed, steam and regeneration** modes.

Fan operation is intermittent.

HACCP

HACCP: serves to record the cooking program in compliance with **HACCP standards (Hazard Analysis and Critical Control Points)**. Depending on the system requested you can record cooking data on a dedicated printer or directly on a PC.



Clean Cycle: automatic or semiautomatic oven cleaning cycle (see section 7. CARE AND MAINTENANCE).



Low speed cycle (fan): for delicate cooking such as for baking cakes. Can be combined with any other cycle.



Reduced power cycle (heating): for delicate cooking such as for baking cakes. Can be combined with any other cycle.



Cooking with ECO-DELTA: for cooking large pieces of food (5kg and above, e.g. whole turkey, leg of pork, etc.). In this cooking mode a temperature setting of between 1°C and 120°C is chosen.

In this case, cooking is moderate and long, because the CHAMBER temperature is automatically adjusted according to that inside the food (CORE PROBE), maintaining a constant difference (ECO-DELTA) between them, from start to end of cooking.

E.g:

COOKING:	START	END
ECO-DELTA =	80°... 80...80...	80...	80°C (set)
CORE PROBE =	10°... 11...12...	40...	60°C (set)
CHAMBER =	90°... 91...92...	120...	140°C (result)



Air-convection cycle with oven chamber vent open: suitable for very dry cooking cycles; allows evacuation of humidity when necessary (maximum temperature 300°C).



Door open indicator LED.



Limescale LED: when this LED starts flashing the boiler needs to be descaled. Follow the instructions in section 7.



Boiler status LED:

- **LED off:** boiler ready;
- **LED flashing:** boiler being filled or no water. **Make sure the oven water supply is working!**



Cooking parameter adjustment: allows adjustment of cooking values (humidity, temperature and time).



Automatic sequence phases: to execute a 2-phase cooking cycle switching from one phase to the other automatically (LEVEL B e C ONLY).

3.5 ADDITIONAL FUNCTIONS

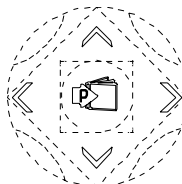

Set of controls for management of the programs library: control keys to store, edit or delete cooking programs (LEVEL A only).



Program selector : to find and select the cooking programs stored in the memory (LEVEL A only).



Manual water injection into cooking chamber: serves to boost humidity levels during the cooking cycle.



Boiler manual water draining: press this button to drain the water from the boiler.

Important! To prevent the build-up of lime-scale inside the boiler:

- Make sure the water supply corresponds with the required characteristics - see Installation.
- Always empty the boiler at the end of each day.

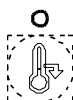

Rapid oven cooling: useful for passing from one type of cooking to another that requires a lower temperature; it allows the fan to run and automatic water (TS < 180°C) injection even when oven door is open.

Important! Risk of burns.
Open the door with due care when the appliance is hot.

Before using the oven check that:

- the external safety electric switch is on;
- the gas shut-off cock is open;
- the water supply cocks are open;
- the fumes and steam discharge outlets are not blocked.

USING THE OVEN

4. OPERATING LEVEL A, B and C (C=Convect, Covection)

Cooking of food is carried out by heating it and can be achieved in a specific MODE, at a specific TEMPERATURE, a specific TIME and HUMIDITY level. Therefore these parameters must be set in order to execute a COOKING CYCLE.

On this basis, the oven functions mainly by carrying out the operations shown in the following headings:

--- SETTING THE COOKING CYCLE ---

- SELECTING COOKING MODE
- SETTING COOKING TEMPERATURE
- SETTING COOKING TIME
- SETTING AND USING THE PROBE
- SETTING COOKING HUMIDITY
- COOKING CYCLE START

There are also several other headings illustrating support functions such as:

- MANUAL CYCLE (CONTINUOUS COOKING)
- UTILITIES
- COOKING PHASES IN AUTOMATIC SEQUENCE

Lastly (with reference to level A ovens), there is a heading describing the storage of cooking cycles as recipes (e.g. CHICKEN RECIPE) or programs, entitled:

- STORING RECIPES OR PROGRAMS

4.1 SWITCHING THE OVEN ON

To switch the oven on press button I of this switch:

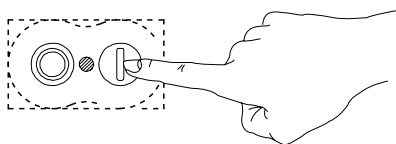

The following will occur:

- the relative button lights up;
- the control panel switches on and various functions flash;
- the Thermometer/Thermostat TS display shows the oven chamber temperature;
- the oven chamber lamp switches on;

- boiler in **filling** phase (flashing LED);

- boiler **ready** (LED off)

4.1.1 SWITCHING THE OVEN OFF

To switch the oven off press button O of this switch:

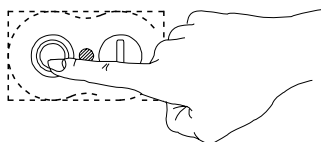

4.2 SELECTING THE CONTROLS (MANUAL or AUTOMATIC)

The control panel is divided in two parts, one for MANUAL controls and the other additional section for AUTOMATIC controls .

MANUAL controls

AUTOMATIC controls

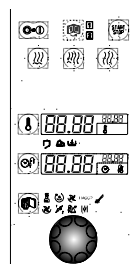

(level B e C)



(level A)

Use one of the two control modes according to your cooking needs in the level A oven.

The level BeC oven is equipped exclusively with MANUAL controls.

4.3 MANUAL CONTROLS

SETTING THE COOKING CYCLE

4.3.1 SELECTING COOKING MODE

After SWITCHING THE OVEN ON select one of the following cooking modes by pressing the relative illuminated button (button lights up):



steam conv/steam air-conv.

Set the cooking parameters as indicated in the following paragraphs.

Note:

The temperature and time displays flash for 5 seconds awaiting setting; if no value is set, the preset value (default value) will remain stored, which stops flashing.

4.3.2 SETTING THE COOKING TEMPERATURE

Press the following illuminated button (button lights up) to select cooking temperature:



The relative DISPLAY will show the TEMPERATURE in the CHAMBER (large numbers) and the TEMPERATURE TO BE SET (small numbers - flash for 5 seconds).

E.g.: 34°C

CHAMBER TEMPERATURE



E.g.: 200°C
COOKING
TEMPERATURE

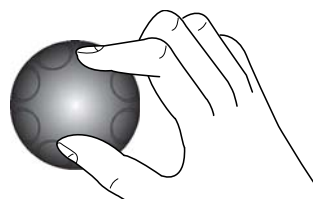

Turn the knob clockwise (to increase the value) or counter clockwise (to decrease the value) to set the desired COOKING TEMPERATURE in the small DISPLAY.

After 5 seconds the COOKING TEMPERATURE stops flashing to indicate that it has been SET.

Note

The temperature of the **steam** cycle is automatically set at 100°C. You can, however, set **low temperature steam** from 25°C to 99°C by turning the knob; superheated steam(temperature from 101°C to 130°).

Note 2

With the COMBI cycle it is possible to do a **dough proving** cycle by setting a temperature below 50°C (25 - 49°C). When the dough proving cycle is set as a first stage **compartment preheating** is excluded.

4.3.3 SETTING THE COOKING TIME

Press the following illuminated button (button lights up) to set cooking time:



The relative DISPLAY will show the TOTAL REMAINING TIME of the cooking cycle (large numbers) and the TIME TO BE SET (small numbers - flash for 5 seconds).

E.g. : 1 h 30'
TOTAL REMAINING TIME



E.g.: 1 h 30'
CURRENT REMAINING TIME

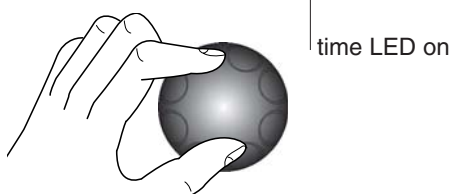

Turn the knob clockwise (to increase the value) or counter clockwise (to decrease the value) to set the desired cooking TIME on the small DISPLAY.

After 5 seconds the COOKING TIME display stops flashing to indicate that it has been SET.

Note:

In this case there is only one cooking cycle or phase so CURRENT remaining time and TOTAL remaining time will coincide.

4.3.4 SETTING AND USING THE PROBE (TO MONITOR PRODUCT CORE TEMPERATURE)

This temperature probe allows high precision control of the temperature reached at the core of the product being cooked so that the desired value can be set and the cooking cycle stopped automatically when the product core reaches the set temperature.

Important: The temperature probe is a precision instrument and must be handled with care. Avoid knocks, do not apply excessive force when inserting the probe, an do not pull on the lead (take care particularly when using roll-in racks). The guarantee does not cover damage to th core temperature probe caused by improper use.

1) Switch on the oven

Remove the product core temperature probe "C" from its seat "D" and insert it into the product without forcing it and making sure that the tip (sensitive element) is located in the proximity of the centre of the product.

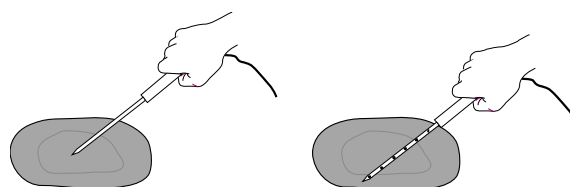
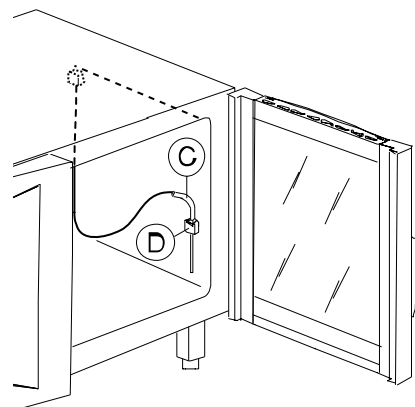

LEVEL B e C probe with 1 sensor LEVEL A MULTIPOINT probe with 6 sensors

The LEVEL A oven is equipped with a MULTIPOINT probe with 6 sensors located at intervals along the wand, enabling the correct temperature to be read in the centre of the product even if the probe tip is not positioned at the product core.

Close the oven door.

2) Select the desired cooking cycle and set the cooking temperature on thermostat TS.

Important: do not set the cooking time on Timer TM.

3) Set the TEMPERATURE of the CORE PROBE by pressing the following illuminated button **twice** (button lights up):

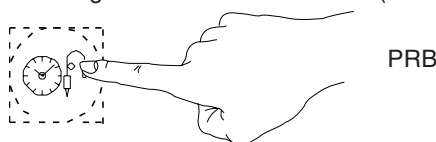

The relative DISPLAY will show the PROBE TEMPERATURE (large numbers) and the TEMPERATURE TO SET (small numbers - flash for 5 seconds).

E.g.: 57°C
CURRENT PROBE TEMPERATURE

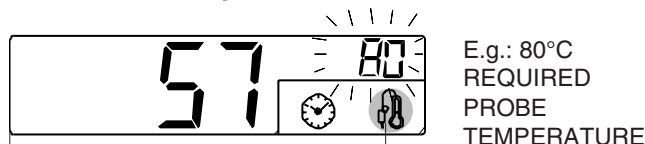

E.g.: 80°C
REQUIRED PROBE TEMPERATURE

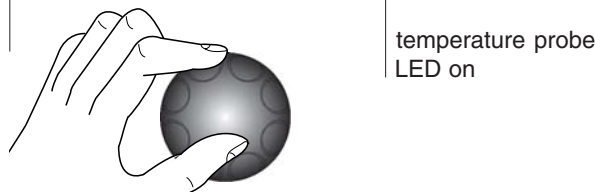

Turn the knob clockwise (to increase the value) or counter clockwise (to decrease the value) to set the DESIRED PROBE TEMPERATURE on the small DISPLAY.

After 5 seconds the DESIRED PROBE TEMPERATURE stops flashing to indicate that it has been SET.

Note:

Press the button again to switch from the PROBE function to the TIME function: the relative LED on the DISPLAY will light up.

4) **Start the cycle.** Press the **Cooking Start/Stop** button.

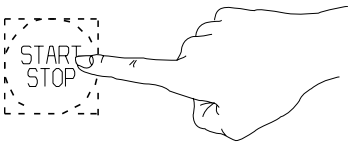

5) **Stop the cycle.** When the required product core temperature reaches the set temperature the oven stops automatically as described in heading 4.3.7 STOPPING THE COOKING CYCLE and elapsed cooking cycle time is shown on the large DISPLAY.

6) **Deactivating core probe mode.** (Possible only with no cooking cycle active). Set a cooking time on Timer **TM**.

Probe cooking mode is also deactivated when the oven is switched off.

At the end of the cycle total cooking cycle TIME is shown on the large DISPLAY.

4.3.5 SETTING COOKING HUMIDITY

LEVEL **A** and **C** ONLY

(Only in **CONVECTION**, **MIXED** and **REGENERATION** cooking modes)

Attention

When switching on the oven after several hours in which it has not been used, wait about 20 seconds (LAMBDA probe stabilisation time) to ensure accurate reading of the HUMIDITY value.

Note

To set humidity in AIR-CONVECTION cooking mode press the relative cycle selection button twice.

After selecting AIR-CONVECTION or MIXED cooking mode the large DISPLAY (LEVEL **A** only) will show OVEN CHAMBER HUMIDITY and the small display (LEVEL **A** 1%...100% and **C** 1/10...10/10) will show the humidity to be SET (flashes for 5 seconds).

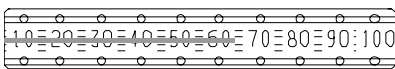

E.g.: 60 %
OVEN CHAMBER HUMIDITY



E.g.: 80 %
COOKING HUMIDITY

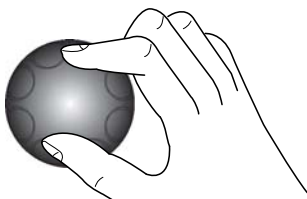

Turn the knob clockwise (to increase the value) or counter clockwise (to decrease the value) to set the desired COOKING HUMIDITY on the small DISPLAY.

After 5 seconds the COOKING HUMIDITY value stops flashing to indicate that it has been SET.

4.3.6 STARTING THE COOKING CYCLE

- make sure the oven door is closed;
- press the luminous start cooking button, which will light up (light FLASHING), for COMPARTMENT PREHEATING;

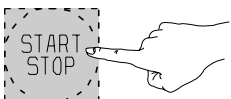

PrEH
Start COMPARTMENT PREHEATING
(light FLASHING)

The displays will show:

- **HU** humidity inside the compartment;
- **TS** automatic compartment preheating (PrEH). To skip preheating press the START button again.
- **TM** time remaining for end of cooking / **PRB** core probe temperature.

Note: In TIMED cooking, during preheating the set cooking time remains unchanged (COUNT-DOWN not activated).

At the end of preheating the message **LOAD** appears on the display **TS**:

- open the oven door and load the food.
- close the door, and the message **Strt** (START) appears on the display **TS**
- press the start cooking luminous button again; it will light up (FIXED light);

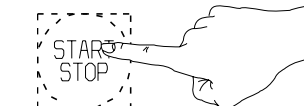

Start COOKING CYCLE
(light FIXED)

(COUNT-DOWN activated)

Note:

- No cooking cycle will be available (steam, mixed, air-convection or regeneration) until the boiler is ready (boiler LED switches off - see heading 4.1).

During this interval the time count will not start and the **Start cooking** button will flash (the same will occur when the oven door is opened).

Important! Risk of burns.

Open the door with due care when the appliance is hot.

4.3.7 STOPPING THE COOKING CYCLE

When the set time has elapsed the cooking cycle will stop automatically and the appliance's audible alarm will emit a continuous beep.

Open the door and remove the product.

Important! Risk of burns.

Open the door with due care when the appliance is hot.

Note:

- The audible alarm can be muted by performing any operation on the control panel or by opening the door.

To stop the cooking cycle **manually** press the **cycle Start/Stop** button and keep it pressed for **two** seconds.

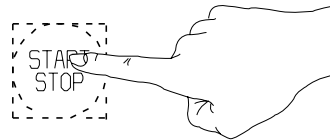

If this button is pressed for less than 2 seconds it will produce no result.

To repeat the last cooking cycle with identical parameters press the **Start/Stop** button again.

4.3.8 MANUAL CYCLE (CONTINUOUS COOKING)

Manual cooking cycles can be set by excluding the timer. Follow the instructions in heading 4.3.2 SETTING THE COOKING TIME until the display shows the word "**cont**", i.e. **continuous** cooking mode.

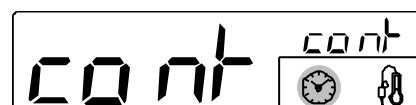

In this case the cooking cycle must be stopped manually by holding down the **Start/Stop** button for two seconds or by switching off the oven.

4.3.9 UTILITIES

- Switch on the oven by pressing button I.
- Set a cooking cycle for the following UTILITIES:



this is not necessary for the other utilities as they are already specific cycles.

- Press button **U** (UTILITY):



- The green UTILITY LEDs will light up and one will be flashing.



- Turn the knob clockwise or counter clockwise to select the utility required - the relative LED will flash (flashing GREEN colour).
- Press button **U** until the flashing LED relative to the UTILITY selected changes colour (flashing ORANGE colour).
- Wait a further 5 seconds for the LEDs relative to the selected utilities to illuminate steadily (steady ORANGE colour).
- Finally, start the cycle by pressing the START/STOP button.

A complete description of the different UTILITIES available is included in heading 3.4 SPECIAL COOKING MODES (page 42).

Note:

If the UTILITIES are not used for 7 seconds they are **automatically cut out**, signalled by the relative button switching off.

- To **cancel one** of the following preset UTILITIES (ORANGE steady):



press the **U** button and turn the knob to select it so that it flashes (ORANGE flashing).

Press the **U** button again so that the UTILITY changes colour (GREEN flashing) and is thus cancelled.

- To **cancel** the other UTILITIES set another cooking cycle.
- In case of **cycle already started**, stop it, keeping the START/STOP button pressed for 2 seconds before cancelling the UTILITY.

4.3.10 COOKING WITH TWO PHASES IN AUTOMATIC SEQUENCE

(LEVEL B and C ONLY)

Level B ovens allow the execution of cooking cycles composed of two sequential phases. For example:

- Phase 1:
 - air-convection 200°C
 - probe 70°C
- Phase 2:
 - mixed cycle 220°C
 - 40 minutes

The oven switches automatically from phase 1 to phase 2. To set a two-phase cycle proceed as follows:

- 1) Switch the oven;

- 2) Set the desired cooking mode, oven chamber temperature, and cooking time (or, alternatively, core probe temperature) as described in this handbook.
- 3) Press the "1-2" / "PHASE" button:

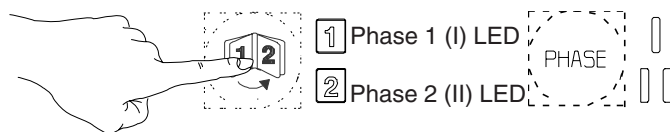

the phase 2 LED switches to RED (active phase) while the phase 1 LED is GREEN (inactive phase); at the same time the **cooking modes** button LEDs start flashing again to request a new setting for phase 2.

- 5) Select:

- phase 2 cooking mode;
- phase 2 oven chamber temperature;
- time (or core probe temperature) relative to phase 2;

- 6) The two-phase cooking cycle has now been set. Place the product to be cooked in the oven and press the START/STOP button to **start the cooking cycle**.

The cooking cycle will start from phase 1 (phase 1 LED RED) and **switch automatically** to phase 2 (phase 2 LED RED) when the first phase terminates.

When the oven switches from phase 1 to phase 2 the operator will be alerted by a brief audible signal.

When phase 2 is terminated the cooking cycle will stop automatically as already described.

4.3.11 Delta Cooking

This is an advanced method of cooking, by which the oven chamber temperature varies in function of the core temperature of the food.

The operator is able to select a **delta** value between $1^{\circ}\text{C} < 120^{\circ}\text{C}$, we recommend using between $20^{\circ}\text{C} < 70^{\circ}\text{C}$. The chamber temperature will be adjusted to automatically remain above the rising core temperature exactly by the set value.

This type of cooking is ideally suited to large joints of meat.

How to use it: Manual cooking mode.

- 1) Select the cooking mode, Ex. **Combi**.
- 2) Set a target core temperature value,
- 3) Go into **advanced utility functions (Bottom row on Control Panel)** and select



At this point you will see on the oven temperature display **25 °C** which is a **Delta** value (you can change it by highlighting the temp area and turning the dial to reach the desired Delta – for example **50°C**.)

Close the oven door and press the start button to activate the cooking cycle.

The core temperature of the meat may be for example **14 °C** when the cooking cycle is started, the oven temperature will go to **75°C**, (**50°C above core temp**), and then keep rising as the core temperature rises, maintaining a difference of **50°C** (As the core temperature of the meat rises by one degree so too does the oven temperature). The two temperatures will displayed in the lower line on the display.

If you selected a final core temperature of for ex. **67 °C**, the final oven chamber temperature will be **117 °C** at the end of the cooking cycle.

This cooking method is much slower than the 'normal' way of cooking but the benefits are higher yields and better quality.

4.4.2 SETTING THE TIME, DATE AND DELAY START

- TIME and DATE -

Proceed as follows to set the TIME and DATE:

- 1) Switch on the oven by pressing button I.
- 2) Hold down button TM until you hear a beep and the HOUR digits start flashing.



- 3) Turn the knob (while the hour digits are flashing) clockwise or counter clockwise to set the current hour.
- 4) Press button TM and set the MINUTES in the same way as for the hours (step 3).

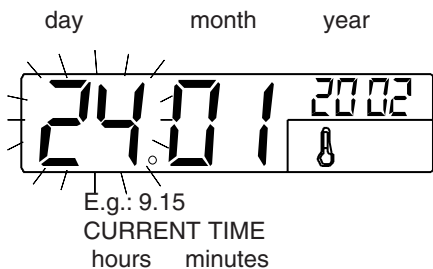

E.g.: 24-01-2002
CURRENT DATE

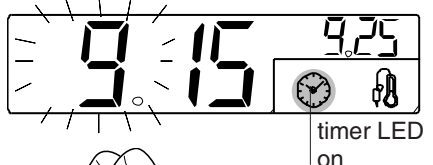

E.g.: 9.25
DELAY START
(10 minutes)

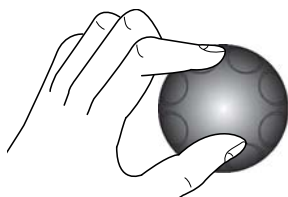

- 5) Press button TM again to set the DATE (shown on the TEMPERATURE DISPLAY) in the same way as the HOURS (previous step 3).
- 6) Press button TM to set the MONTH and YEAR repeating the procedure used to set the date.

- DELAY START- (delayed start of cooking cycle)

Once the TIME and DATE have been set (see previous heading) carry out these operations:

- 1) Press button P (program) and select the required recipe or program:



- 2) Press button P and select P: ADD DELAY.

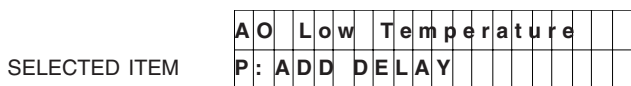

- 3) Press button P: a flashing letter D (Delay Start) will be displayed.

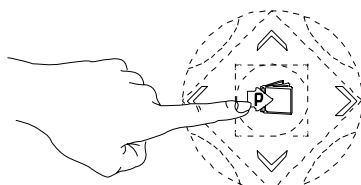

- 4) Set the required START time (shown in small numbers on the TM timer display) and press the START/STOP button. The cycle will start at the time set in the DELAY START option and the letter D will flash in alternation with a dot to remind the user that this function is active.

4.4.3 EDITING THE SET PARAMETERS

With the cooking cycle **blocked, started or stored**, use the relative commands to edit the following parameters:

- 1) cooking mode;
- 2) cooking temperature TS;
- 3) cooking time TM;
- 4) probe temperature PRB (in alternative to cooking time).

Note:

- When you edit the parameters of a STORED cooking program (during a cooking cycle) an asterisk "*" will appear alongside the program number.

- Editing the parameters of a STORED cooking program overwrites the original parameters with the new ones.

Proceed as follows if the oven is performing a **cooking cycle composed of various phases** and you wish to edit the parameters of the next phase to be executed:

- a) Press the START/STOP button to stop the current cooking cycle.
- b) Press the (>) button to display the phase you intend to edit, and enter the new values.
- c) Press the START/STOP button to resume the current cooking cycle.

4.4.4 STORING RECIPES OR PROGRAMS

RECIPES or programs (cooking cycles) can be stored with a sequential number and a descriptive name to assist in retrieval.

E.g.: -01----- (RECIPE n°)
CHICKEN (RECIPE description)
-02-----
POTATOES

Once a RECIPE (composed of one or more cooking phases) has been set using the **MANUAL** or **AUTOMATIC CONTROLS** carry out these operations:

- 1) Press button P

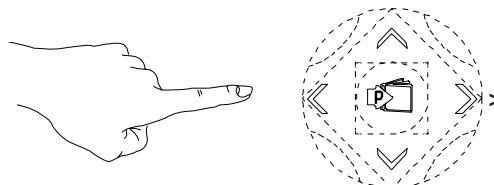

- 2) Press button P again to open the menu and select the MEMORIZE RECIPE option.



- 3) Press button P to start saving data, the SELECT NUMBER option is displayed.

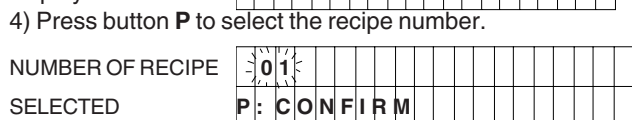
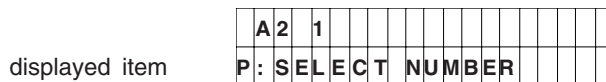

5) Select (while flashing) the RECIPE number in which you want to store the cycle you have just set up and confirm the number by pressing button **P**.

6) Select the EDIT NAME option

selected item	01																			
	P: EDIT NAME																			

7) Press button **P**, the dash "-" flashes.

DASH FLASH.	01																			
selected item	P: CONFIRM																			

8) Select the first letter required.

9) Press button (>) to enter the next letter as described in point 8 and so on for the rest of the letters to complete the description of the program (to DELETE a letter select the space).

10) Press button **P** to confirm the RECIPE NAME (e.g.: COOKING CHICKEN).

NAME RECIPE	01	C	O	O	K	I	N	G	C	H	I	C	K	E	N						
selected item	P: CONFIRM																				

11) Select the SAVE RECIPE option and press button **P** to save.

NAME OF RECIPE	01	C	O	O	K	I	N	G	C	H	I	C	K	E	N					
selected item	P: SAVE RECIPE																			

12) Press button **P** again for a few seconds to exit the programs (or select the EXIT option and then confirm).

Note: it is not compulsory to save programs in sequence (e.g. 01-02-03, etc.): you can assign programs with any number from 0 to 99. Numbers already used for another program are marked with a dot alongside, while unoccupied numbers are shown without a dot.

4.4.5 RECIPE OR PROGRAM SEARCH

There are two methods for finding a recipe or program:

- SEARCH BY NUMBER (recipe or program number)

- SEARCH BY NAME (recipe or program name)

Note:

When setting a cooking cycle, press the **P** button twice and select the menu item FIND BY NUMBER OR FIND BY NAME, or press **P**, holding it down for a few seconds to exit cycle setting and proceed as follows.

SEARCH BY NUMBER

Press button **P** and select the desired recipe or program.

SEARCH BY NAME

Press button **P** to open the list of recipes or programs.

program	AO	Low	Temperature																	
selected	P: MENU																			

Press the button **P** and select the item SEARCH BY NAME

program	AO	Low	Temperature																	
selected	P: SEARCH BY NAME																			

Press button **P** to begin the search and select the **first letter** of the name of the desired recipe, e.g. G (GOOSE).

letter G	AO	G																		
flashing	P: CONFIRM																			

Press the button **P** to confirm this letter, the first recipe or program starting with the letter G appears on the display.

first recipe
with letter G

14	G	A	M	M	O	N														
P: MENU																				

Select the name of the **desired recipe** from those beginning with the letter G.

desired recipe
selected

15	G	O	O	S	E															
P: MENU																				

4.4.6 USING PRESET PROGRAMS

Undeletable preset programs provide several standard service functions.

The oven is supplied with the following preset programs:

LOW TEMPERATURE COOKING (EFS-LTC)

Cooking at low temperature is a specific cooking procedure especially for beef, e.g. prime rib, beef fillet, top round, tenderloin, but also for other meat items like veal, lamb, venison, turkey, duck, pork, etc

The meat cuts can be: strip loin, shoulder, leg, saddle, T-bone steak, rump, fillet, chops, etc.

The EFS-LTC is a preset, fully automatic program to obtain matured, tender and uniform cooked food.

The program comprises 4 main phases:

PREHEAT, SEARING, MATURE, HOLD.

Set the program as indicated below for the pre-sorted programs. When the word LOAD appears on the large display, after the PREHEAT phase

(If necessary change the already set cooking chamber temperature)

PLACE the food in the oven and insert the 6 Point Multi Sensor, core probe.

(If necessary change the already set probe temperature).

Close the door and start the cycle by pressing the START button again.

The SEARING (sealing of the food by dry heat) phase starts, followed by the suddenly Cool Down for subsequent slow cooking; in the MATURE phase (responsible for tenderising the meat) the relevant duration flashes on the large display of the core probe (press any button and the duration disappears).

This is followed by the final HOLD phase to keep the food on a certain temperature.

The entire LTC cycle (including the HOLD phase) can last for a max. of 24 hours.

One or more phases can be skipped, going to the next phase (see SKIP PHASE in par. 4.4.1 AUTOMATIC SEQUENTIAL MULTIPHASE COOKING); this is useful, for example, when cooking is started (SEARING phase) with another appliance (e.g. fry top) and is to be completed in the oven (MATURE and HOLD phases).

The MATURE phase cannot be skipped; this means that if only the HOLD phase is to be used just set the relevant UTILITY (see par. 4.3.9 UTILITIES).

Major advantages:

- Excellent food quality.
- Standardized procedure LTC guarantees repeatable results year-in - year-out.
- Typical roast aroma, juiciness from centre to the rim.

- Uniform colour and perfected evenness in the degree of doneness.
- Fast maturing process - time saving and use of fresh cut.
- Significant less cooking shrinkage, 5-8 % (depend on food quality and selected core temperature).
- Remarkable gain of portions for selling.
- Dramatic energy-saving due to the intelligent EFS - LTC program.

CLEANING SYSTEM

This system executes an automatic oven chamber cleaning procedure using suitable detergents according to the level of soil detected; the program has four different cleaning cycles.

CLEAN 1 Soft (light)

For fresh soil deriving from low fat cooking (e.g. after a STEAM cooking cycle)

CLEAN 2 Medium (normal)

If the oven chamber is only moderately soiled and after cooking fatty foods.

CLEAN 3 Strong (intensive)

If the oven chamber is very dirty due to cooking of high fat foods (e.g. roasted chicken, sausages).

CLEAN 4 X-Strong (super intensive)

For heavy grime resulting from very high fat foods (e.g. roasted chicken, sausages) also with dry residues (baked-on food).

F00...----> F19... (recipes)

These are the 20 pre-stored recipes of the main international dishes.

For further information see the relative recipe book.

Proceed as follows to use preset programs:

Note 1:

Before cleaning the compartment with the CLEANING SYSTEM remove the **grease filter** (if present).

The CLEANING SYSTEM cycle **will commence** when the temperature automatically reaches **70°C in the oven chamber**.

Before carrying out a CLEANING SYSTEM cycle make sure the containers (located under the control panel) are supplied with cleaning products of the required type: refer first to section 7. CARE AND MAINTENANCE.

Warning:

In case of complete emptying of the detergent and/or rinse aid containers or emptying of their supply tubes, the **CLEANING SYSTEM** cycle must be started after firstly doing the CLEAN 1 cycle, then the same or other cycles. This operation allows the pipes to be refilled with the appropriate liquids and the cleaning cycles to be done correctly.

If the **CLEANING SYSTEM** is not used for long periods, it is necessary to do a cleaning cycle (CLEAN 1) with water instead of detergent and rinse aid before and afterwards, to flush the respective supply pumps.

Note 2:

When setting a cooking cycle, press the **P** button twice and select the menu item FIND BY NUMBER OR FIND BY NAME, or press **P**, holding it down for a few seconds to exit setting and proceed as follows.

- 1) Press button **P**, program **A0** flashes

program	A0 Low Temperature										
selected	P: MENU										

the wording A0 Low Temperature appears on the DISPLAY.

- 2) Select the desired program or go to step 3).
- 3) Press the START/STOP button to start the A0 Low Temperature cycle (or the selected program).

To **exit, edit, skip phase**, see the paragraphs of the normal programs.

4.4.7 DELETING A RECIPE OR PROGRAM FROM THE MEMORY

- 1) Press button **I** to switch on the oven.
- 2) Press button **P**.
- 3) Select the recipe or the program to be deleted.
- 4) Press button **P** and select the CLEAR RECIPE option.

RECIPE NAME	01 COOKING POTATOES										
selected option	P: CLEAR RECIPE										

- 5) Press button **P** to remove the recipe or program from the memory.

RECIPE NAME	01 COOKING POTATOES										
selected option	P: CONFIRM										

- 6) Press button **P** again and hold it down for a few seconds to exit the programs.

4.4.8 PASSWORD

The **PASSWORD** function must be enabled by changing several parameters; for that purpose request the assistance of our After-Sales Service.

The **PASSWORD** allows the following functions to be locked in order to limit oven use (one or more by request):

- Disables the temporary modification of automatic programmes, including the special PreHeat, Low Temperature cycles and Recipes.
- Manual cooking cycles are made unusable.
- Prevents final modification, saving or cancellation of the automatic programmes.

Once the **PASSWORD** is enabled, the oven is locked (after switching on) against the use of the above functions; a password must be entered to unlock it.

To **enter** a password:

- 1) press button twice **P** and select the item **PASSWORD**, press **P** again, and the display shows:

_____***** factory-set oven password
(8 characters formed of 8 empty spaces)

- 2) Press **P** (oven unlocked) and select **CHANGE PASSWORD** with the arrow button "v" (down).

- 3) Press **P**, the item **New PASSWORD** appears, enter the password (alphanumeric 8 characters or less) like entering the name of a recipe (see par. 4.4.4 **STORING RECIPES** or **PROGRAMMES**).

- 4) Press **P**, the item **CONFIRM PASSWORD** requests confirmation of the password entered by typing it again, then press **P**. After a short beep signalling successful operation, or a long beep if failed, the oven goes to the initial switching on status and is thus unlocked.

To lock it again, just switch it off.

To **change** a password repeat the previous operations from point 2).

To quit the menu, if the **PASSWORD** is not known, switch the oven off and then on again.

5. INFORMATION AND ERROR CODES

These codes may appear on the time display.

INFORMATION codes

Codes indicating a value, function, or state.

- CIn** - CLEANING SYSTEM program switched on.
- CInt** - Semiautomatic cleaning program switched on.
- cont** - Unlimited time setting.
- cool** - Oven cooling on.

ECLO - Clock error appears if the time has never been adjusted. To eliminate the error set the time.

End - End of a cycle or function.

FILL - Boiler filling. (Ensure water supply tap/cock are open).

LOAD - Place the food in the oven.

oPEn - Boiler discharge valve opening.

PrEH - (TIME TM / PRB DISPLAY)Boiler preheating.

PrEH -(COMPARTMENT TEMP. DISPLAY TS) Automatic compartment preheating.

Soap - Detergent. Spray a suitable product on the surfaces to be cleaned as indicated in point 4) of the semiautomatic chamber cleaning cycle (see par. 7. CARE AND MAINTENANCE).

Strt - Press the START button to start the program.

Stby - CLEANING SYSTEM cleaning standby time.

ERROR codes

Codes indicating the need to call technical service

burn - Burner lockout with manual reset by pressing START/STOP button momentarily. The small DISPLAY shows the following reference to the type of burner:

- CAUP single convector (6-10 GN) or upper convector (20 GN)
- CADO lower convector (20 GN only)
- BOUP single boiler (6-10-20 GN)
- BODO lower boiler (20 GN2/1 only).

EH20 - Water supply pressure too low for CLEANING SYSTEM (pressure requirements from 1.5 to 2.5 bar).

EFUN - Fan automatic reset thermal switch device. UP appears on the small DISPLAY with reference to the single fan (6-10 GN) or upper fan (20 GN) of the chamber and DO in reference to the lower fan (only 20 GN).

E--- - Non-compliance with a parameter requirement (number of parameter appears in place of dashes “—”).

EPt1 - Chamber sensor interrupted or short-circuited.

EPt2 - Boiler sensor interrupted or short-circuited.

EPt3 - Probe sensor interrupted or short-circuited.

EPt4 - Bypass sensor interrupted or short-circuited.

EPt8 - Electronic controller temperature sensor damaged.

ESCH - Malfunction of commands control circuit cooling devices.

Etub - Boiler overtemperature (125°C) warning.

Etuc - Chamber overtemperature (320°C) warning.

EFLP - Fault in chamber steam discharge motor-operated valve.

ETC - Tripping of chamber temperature limiter.

ETB - Tripping of boiler temperature limiter.

IMPORTANT!

If an error code is displayed during a cooking cycle, the oven emits a continuous audible warning signal and the cooking cycle is interrupted.

In this case the oven can be used only in cooking modes that do not involve the conditions that generated the error.

Notify your Technical Service Centre of the alarm code displayed.

6. SWITCHING OFF IN THE EVENT OF A FAULT

If the appliance malfunctions, switch off as follows:

- Switch off the automatic circuit breaker upline from the appliance and turn off the water and gas cocks .
- Contact a service centre with personnel trained and authorised by the manufacturer.

7. CARE AND MAINTENANCE

- At the end of each day clean the oven interior with an oven cleaner, following the product supplier's directions.
- Do not wash the appliance with water jets.
- Do not clean steel surfaces with products containing chlorine (bleach, hydrochloric acid etc.) even diluted.
- Do not use corrosive substances (e.g. muriatic acid) to clean the floor under the appliance.

A and **C (B, if fitted) LEVEL** the appliance has an automatic compartment cleaning programme called CLEANING SYSTEM; for its use see par. 1.4.3 USING PRESTORED PROGRAMMES for LEVEL **A**, whereas for LEVEL **C (B, if fitted)** see below.

The CLEANING SYSTEM program uses detergent and rinse aid. Therefore, fill the DETERGENT container - max. 5 litres (on the RIGHT with RED cap) and the RINSE AID container - max. 1,2 litres (on the LEFT with BLUE cap) located under the control panel:

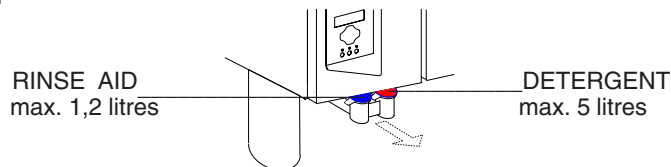

For models 20GN1/1-2/1 connect the tubes (supplied) on the left side of the oven (RH connection RED symbol for DETERGENT; LH connection BLUE symbol for RINSE AID) and insert the other ends in their respective containers (not supplied) filled with DETERGENT and RINSE AID.

To ensure best cleaning results, as well as to protect the oven with the integrated CLEANING SYSTEM, the following detergents must be used:

- ELECTROLUX "ExtraStrong Clean for Oven" - Detergent (Code 0S1192)
- ELECTROLUX "ExtraStrong Rinse for Oven" - Rinse Aid (Code 0S1193)

Do not use detergent or rinse aid powder dissolved in water or in gel form and containing chlorine.

ATTENTION:

The warranty does not cover damage caused by the use of detergents and rinse aids not complying with the above characteristics.

- Detergent and rinse aid containers, independent of the oven, must not be placed higher than the appliance support surface (for model 6 GN they must be placed lower than the oven support top).

The oven features a UTILITY to perform a automatic or semiautomatic oven chamber cleaning cycle. Proceed as follows. In the level **A** oven, carry out the AUTOMATIC cleaning cycle by following the instructions in par. 4.4.6 CLEANING SYSTEM.

----- AUTOMATIC (C) (B, if fitted) -----
and SEMIAUTOMATIC (A-B-C) cycle

- 1) - Remove any large food remnants using a water jet. **Do not use the spray shower or water jets to quickly cool the compartment and the inside glass of the oven door.**
- 2) - Set the following UTILITY as described in heading 4.3.9 UTILITIES:



3) - Select one of the following wash cycles by turning the knob on the display TS:

CLNT (semiautomatic) (level **A-B-C**)

CLN1...2...3...4 (automatic) (level **C**) (**B**, if fitted) only for the description of these cycles see CLEANING SYSTEM in par. 4.4.6.

4) - Press the following button to confirm the selection



5) - Start the cycle by pressing the START/STOP button.

----- SEMIAUTOMATIC Cycle only (**A-B-C**) -----

The cycle **will commence** when the temperature automatically reaches **100°C in the oven chamber**.

6) - The 1st cleaning phase (STEAM cycle) ends after 5 minutes, as signalled by the audible alarm.

7) - Open the oven door and spray the surfaces to be cleaned with a suitable cleaning product.

8) - Close the oven door. On the **TS DISPLAY** the 120 second pass, to allow the degreasing agent to perform its action. At the end of the degreasing phase the 2nd cleaning phase (STEAM cycle) lasting 10 minutes starts, after which the alarm sounds (cycle finished).

9) - Open the oven door and rinse the interior of the chamber.

To facilitate the oven chamber cleaning procedure, remove the guides for roll-in racks located at the bottom of the cooking chamber and open the suction wall.

• To open the oven compartment suction wall A (Fig. 2) proceed as follows:

- switch the oven off and disconnect the power to the appliance;
- undo (1a) screw B2 completely with a screwdriver,
- insert the tip of a screwdriver in slot B and prise (1b) inwards to open the wall, unhooking it from the pegs B1 at the back.

To **remove** the suction wall **completely** follow these instructions:

- unscrew nut C1 with a hex wrench (2).
- lift (3) the suction wall to disengage it (4) from the lower pin C of the oven chamber;
- lower (5) the wall to disengage upper pin D and then withdraw the wall completely (6).

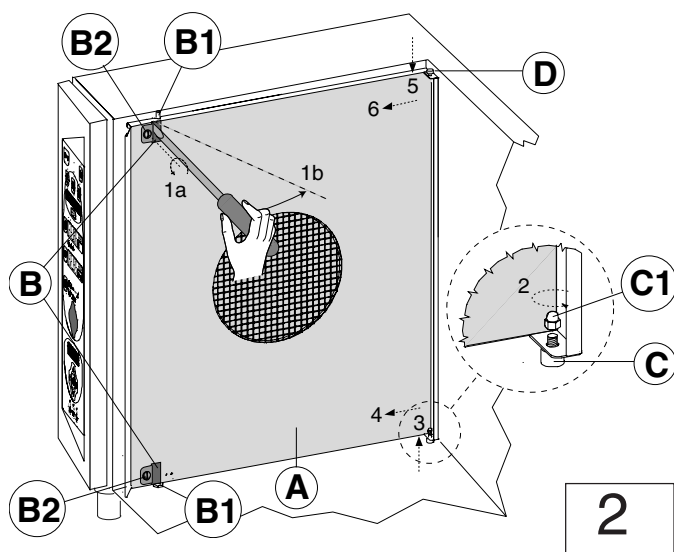

To refit the suction wall, repeat the steps in reverse order and retighten nut C1.

• If present, clean the oven compartment **grease filter** (not supplied) at least every three cooking cycles.

• If present, clean the **air filter** (not supplied) at least once a month, removing it from **under the control panel**.

Failure to clean the filter may affect its performance and impair cooking.

- Each day wash the stainless steel surfaces with lukewarm soapy water and then rinse and dry thoroughly.
- When cleaning stainless steel, never use abrasive tools such as steel wool, wire brushes or scrapers, since they may leave ferrous particles which will promote rusting on the steel surfaces.
- If the appliance is not to be used for long periods, proceed as follows:
 - Disconnect the electrical power supply and turn off the water and gas cocks; .
 - Using a cloth soaked in vaseline oil, vigorously rub the stainless steel surfaces to apply a light protective film;
 - Periodically air the place of storage.

7.1 PERIODICAL MAINTENANCE OF THE BOILER

• The build-up of lime-scale inside the boiler is signalled by illumination of the LED shown below.



When this LED illuminates the boiler must be descaled.

The manufacturer declines all liability for failure to clean the boiler when necessary. Moreover, the repair or replacement of scale-damaged parts is not covered by the guarantee if the characteristics of the water supply do not comply with those stipulated (see corresponding paragraph).

The boiler may be descaled using either:

- pure vinegar (100%);
- or
- a chemical descaler (as instructed below).

The oven must be switched on prior to descaling the boiler.

7.1.2 VINEGAR CLEANING METHOD

- 1) Close the water supply cock.
- 2) Empty the boiler by pressing the drain button



- 3) Close the boiler drain after one minute by pressing the above button.
- 4) Remove the plastic cap from the boiler filler pipe and pour in 8 litres (6-10gn) or 16 litres (20gn) approx. of pure vinegar.
- 5) Open the water cock.
- 6) Run a "steam" cycle for 16 minutes.
- 7) Switch off the oven and wait 60 minutes.
- 8) Restart the oven in steam mode for a further 2 minutes.
- 9) Switch off the oven again and wait 60 minutes.
- 10) With the water cock open, re-open the drain outlet and drain off the vinegar (press the above button).
- 11) Switch off the oven.
- 12) Insert a rubber hose inside the boiler filler pipe and rinse thoroughly until the water flowing out of the drain is clear.
- 13) Refit the filler plug and close the boiler drain (press the above button).

7.1.3 DESCALER CLEANING METHOD

If you decide to descale the boiler using a chemical product, follow the directions provided by the product supplier. For example, when using ECOLAB's "STRIP-A-WAY" descaler, proceed as follows:

- Follow the instructions given in the previous paragraph and supply the following product quantities via the boiler filler pipe:
 - 2 litres of descaler liquid plus 6 litres of water (6-10gn).
 - 4.5 litres of descaler liquid plus 11.5 litres of water (20gn).
- Run a "steam" cycle for 12 minutes.
- Switch off the oven and wait 40 minutes.
- Reopen the boiler drain outlet and proceed as described in the paragraph above.

IMPORTANT-1

Insert a rubber hose inside the boiler filler pipe and rinse thoroughly with water to remove all traces of descaling agent.

- Refit the filler plug and close the boiler drain (by pressing the relative button).

After descaling the boiler, it is good practice to execute a 30-minute STEAM cycle with the oven empty.

IMPORTANT - 2

If the water supply cock cannot be easily accessed, to empty the boiler proceed as follows:

- 1) Open the boiler discharge valve with the special pushbutton.
- 2) Wait 2 minutes and switch the oven off; the discharge valve will close automatically.

7.2 REPLACING CONSUMABLE COMPONENTS

Changing the oven chamber lamp (Fig. 3)

If the oven chamber lamp burns out, replace as follows:

- Disconnect the appliance from the power supply.
- Unscrew the four screws fixing flange "A" and remove glass shield "V" together with seal "G".
- Remove halogen lamp "L" and fit an equivalent lamp with identical characteristics (12V - 10W - 300°C). Important: do not touch the new lamp with your fingers, wrap it in paper or a clean cloth when fitting.
- Refit the glass shield with the seal in the lamp recess then smear food grade silicone grease on the seal and secure the flange using the four screws.

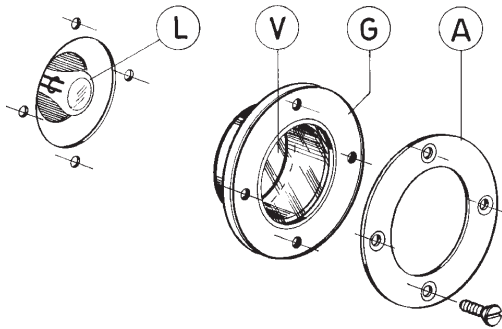

3

Replacing the oven door seal (Fig. 4)

N.B.: The oven door seal is prone to normal wear and aging and should be replaced whenever it starts to harden or crack.

To change the oven door seal proceed as follows:

- prise the seal out of its seat and remove all traces of old silicone from the channel.
- apply a bead of silicone sealant in point 1 along the internal frame of the seal seating channel.
- insert the new seal, pressing it home along the entire length of the channel.

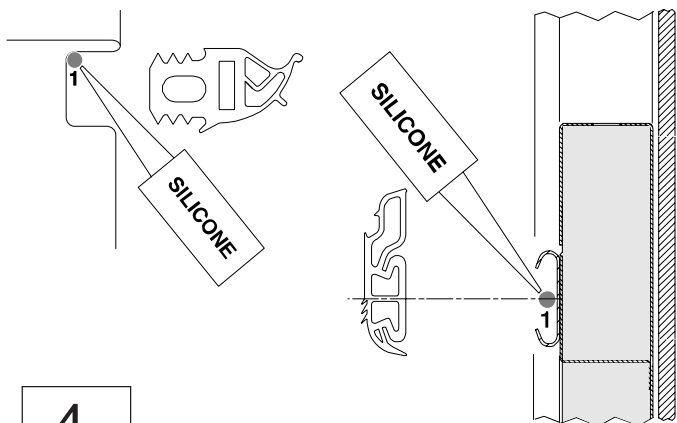

4

7.3 SPECIAL CLEANING INSTRUCTIONS

Cleaning and checking the drain system

Periodically clean the drain pipe and check for obstructions that may prevent the water from draining.

Cleaning the oven door glazing panels (Fig. 5)

Only clean the panels when the glass is cool and never use abrasive cloths or detergents.

To access the double glazing cavity, open the internal panel, which is hinged to the door.

- Open the oven door and press both upper and lower clips F to release the internal glazing panel.

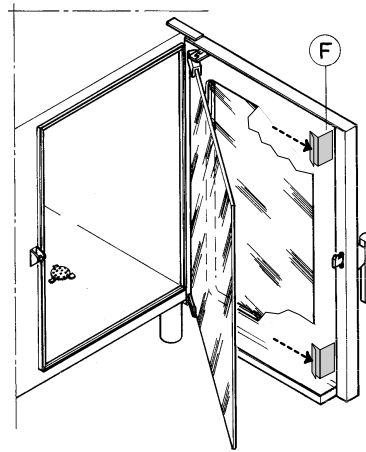

5

After cleaning close the internal panel ensuring it is properly seated against the rubber stops.

CLEANING SYSTEM rotary spray arm (Fig. 6)

Clean the spray arm in the following cases:

- prolonged disuse of the CLEANING SYSTEM
- faulty rotation of the spray arm (nozzles probably blocked)
- use of the appliance with very hard water.

If the nozzles are completely blocked, remove scale deposits using the tip of a knife.

- Disengage (without removing) spring clip A from the central block of the spray arm. For this operation, insert the tip of a screwdriver in the position shown by the arrow and turn it from the vertical to the horizontal position as shown in the figure.
- Remove the spray arm from its hub.

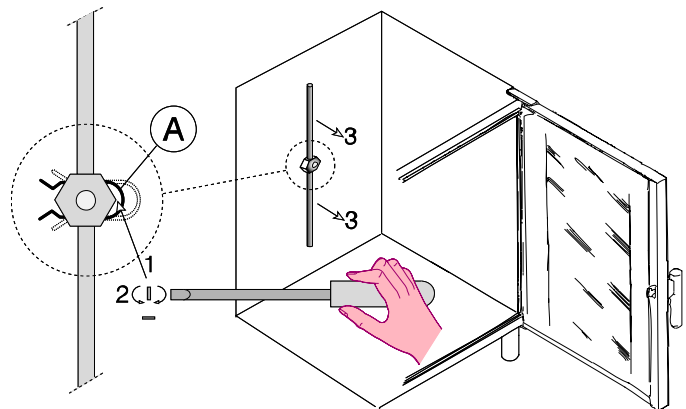

6

- Place the spray arm in a bowl full of descaling agent and leave it to soak overnight, rinsing thoroughly before refitting.
- Refit the spray arm by inserting it over the hub and returning the spring clip to its original position.