



# OPERATING INSTRUCTIONS

## ***LOW TEMPERATURE COOK & HOLD***

***Cooks and Roasts with Natural Browning:  
No Browning Agents Required***



LCH-18



COOK BY PRODUCT PROBE  
OR TIME



LCH-4



LCH-10



LCH-6/6S



# **FWE LOW TEMPERATURE COOK & HOLD OVENS**

## **BEFORE SETTING UP**

### **DELIVERY INSPECTION**

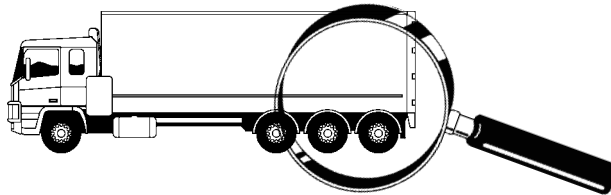

All FWE ovens are shipped in containers in to prevent damage. Upon delivery of your new oven:

- Inspect the shipping container for external damage. Any evidence of damage should be noted on the delivery receipt which should be then signed by the driver.
- Uncrate the oven and check for external damage. Carriers will accept claims for concealed damage if notified within fifteen (15) days of delivery and shipping container is retained for inspection.

The FWE - Food Warming Equipment Company - cannot assume responsibility for loss or damage suffered in transit. The carrier assumed full responsibility of delivery in good order when shipment was accepted. We are, however, prepared to assist you if filing a claim is necessary. Notices are posted on the outside of each carton regarding freight claims and damage to further familiarize you with this information, as shown here.

All units are factory tested for performance and certified free from defects when shipped. The utmost care has been taken in manufacturing, crating and final inspection at the factory and / or shipping point to assure against damage in transit.

Should there be noted damage upon uncrating, carefully check the crate for visible signs of the cause. Save all crating material and immediately file a claim of damage with the carrier. Under no conditions may a damaged unit be returned to FWE without an RGA - *Return Goods Authorization Number*. If damage is discovered, call your dealer, trucking company & FWE - Customer Service Department at 815-459-7500.

#### **IMPORTANT**

This merchandise has been thoroughly inspected and carefully packed before leaving our plant. Responsibility for its safe delivery was assumed by the carrier at the time of shipment. Claims for loss or damage to the contents, should therefore, be made upon the carrier as follows:

**In case of damage, it is your responsibility to  
SAVE ALL CARTON(S) AND PACKING MATERIALS  
for the carrier's inspection.**

#### **VISIBLE LOSS OR DAMAGE**

Any external evidence of loss or damage must be noted on the freight bill or express receipt, and signed by the carrier's agent.

Failure to **ADEQUATELY DESCRIBE EXTERNAL DAMAGE** of loss or damage may result in the carrier refusing to honor a damage claim. The form required to file such a claim will be supplied by the carrier.

#### **CONCEALED LOSS OR DAMAGE**

Concealed loss or damage means loss or damage that does not become apparent until the merchandise has been unpacked. The contents may be damaged in transit due to rough handling even though the carton may not show external damage. When the damage is discovered upon unpacking, **SAVE PACKING MATERIALS, TAKE PHOTOS OF DAMAGE** and make a written request for inspection by the carrier's agent within fifteen (15) days of the delivery date. Then file a claim with the carrier since such damage is the carrier's responsibility. By following these instructions carefully, we guarantee our full support of your claims to protect you against loss from concealed damage.

**DO NOT RETURN DAMAGED MERCHANDISE  
TO US. FILE YOUR CLAIM AS ABOVE.**

# ***FWE LOW TEMPERATURE COOK & HOLD OVENS***

## ***TABLE OF CONTENTS***

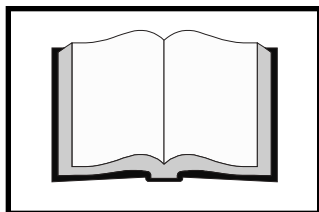

Upon Delivery .....	5
Location and Ventilation .....	6
Electrical Requirements.....	7
Equipment Installation.....	8
Introduction and Equipment Features .....	9
Initial Start-Up & Operating Instructions.....	10
General Cleaning and Maintenance.....	12
Food Safety.....	14
HACCP Seven Step Food Guidelines.....	15
Table A - Critical Control Points.....	15
Table B - Storage Shelf Life .....	16
Table C - Storage Life of Chicken .....	16
Table D - Bacteria Growth on Chicken .....	17
Table E - Internal Cooking Temperatures.....	17
Quick Reference Outline.....	18
Minimum Cook Times.....	19
Table F - Water Content of Food.....	20
Operating Tips .....	21
Cooking Guidelines.....	22
Trouble Shooting Chart .....	23
Electrical Parts Identification .....	24
Replacement Parts List.....	25
Wiring Diagram for Manual Controller.....	26
Service Record.....	27
Warranty.....	28

# ***FWE LOW TEMPERATURE COOK AND HOLD OVENS***



## ***CONGRATULATIONS . . .***

...and thank you for purchasing an FWE Low Temperature Cook & Hold Oven. Your unit has been designed and manufactured under rigid controls to assure you the most efficient service. It is a full time unit, and may be used continuously.

Please take a moment to read through this booklet of important information pertaining to your cabinet. By following a routine of proper use and care described on the following pages, your cabinet will last for many years.

### **IMPORTANT THINGS TO DO:**

- Properly uncrate your unit and check for any possible damage.
- Read this operating manual and instructions.
- Return your warranty & manufacturer Registration Card. Your **Manufacturer Registration Card** must be returned within 30 days after initial delivery to put warranty into effect.
- Review installation instructions and have your unit(s) properly installed.
- Make sure all operators understand the contents of this manual, operation, and food safety information.

## ***IMPORTANT***

This information contained in this manual is important for the proper installation, use, and maintenance of this oven. Adherence to these procedures and instructions will result in satisfactory performance and results as well as long trouble-free service. Please read this manual carefully and retain it for future reference. All operators of this equipment should be familiar with the operation of this unit and have access to this manual for easy reference.

## ***FOR YOUR SAFETY - PLEASE NOTE :***

THE INFORMATION CONTAINED IN THIS SECTION IS PROVIDED FOR THE USE OF QUALIFIED OPERATING PERSONNEL. QUALIFIED OPERATING PERSONNEL ARE THOSE WHO HAVE CAREFULLY READ THE INFORMATION CONTAINED IN THIS MANUAL AND ARE FAMILIAR WITH THE FUNCTIONS OF THE OVEN AND/OR HAVE PREVIOUS EXPERIENCE WITH THE OPERATION OF THE EQUIPMENT DESCRIBED. ADHERENCE TO THE PROCEDURES RECOMMENDED HEREIN WILL ASSURE THE ACHIEVEMENT OF OPTIMUM PERFORMANCE AND LONG, TROUBLE-FREE SERVICE.

**Please take the time to read the following safety and operating instructions.  
They are the key to the successful operation of your FWE oven.**

**WARNING:** IMPROPER INSTALLATION, ADJUSTMENT, ALTERATION, SERVICE OR MAINTENANCE CAN CAUSE PROPERTY DAMAGE, INJURY OR DEATH. READ THE INSTALLATION, OPERATING AND MAINTENANCE INSTRUCTIONS THOROUGHLY BEFORE INSTALLING OR SERVICING THIS EQUIPMENT.

# **FWE LOW TEMPERATURE COOK & HOLD OVENS**

## **UPON EQUIPMENT DELIVERY**

### **UNPACKING**



After uncrating your cabinet, remove all packing materials from inside the cabinet, remove all tape, zip-ties, and padding which held all doors, shelves, racks, cord, etc., in place during shipment.

### **SERIAL AND MODEL NUMBER**

These serial number and model number are found on the nameplate (serial tag) affixed to the lower back of the unit. Please record them in this booklet, here in the space provided and on page 27. When ordering parts and / or service, you will need to provide this information. The voltage and amperage of the unit are also stamped on the serial tag.

All FWE Models are manufactured to high demanding standards outlined by several agencies known throughout the industry. Our models are recorded with our Service Department In the event of any further questions concerning your unit, please refer to the Model and Serial Numbers found on the name plate affixed to the unit. It is our pleasure to help assist you in every possible way.

### **VERIFY ELECTRICAL REQUIREMENTS BEFORE PLUGGING UNIT INTO POWER SOURCE.**

 FOOD WARMING EQUIPMENT CO. INC. CRYSTAL LAKE, IL USA 815-459-7500	MODEL NO.	VOLTS
	<input type="text"/>	<input type="text"/>
	SERIAL NO.	AMPS
	<input type="text"/>	<input type="text"/>
	<input type="text"/>	WATTS
	<input type="text"/>	<input type="text"/>

# ***FWE LOW TEMPERATURE COOK & HOLD OVENS***

## ***SETTING UP***

### ***OVEN LOCATION***

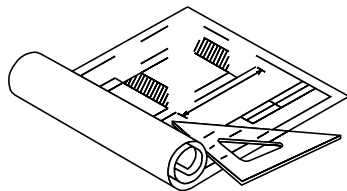

The well planned and proper placement of your oven will result in long term operator convenience and satisfactory performance.

- Proper clearance must be kept on both the left and right of the cabinet, allowing proper ventilation to the cooling fans. As the oven achieves heat, latent heat will build inside the control panel area. Cooling fans assure that these temperatures are kept to a minimal. If proper clearance of these vents are NOT kept, heat will quickly build up. The thermal protectors will trip, shutting the unit down. Improper installation, or failure to keep proper clearance will void warranty.
- Keep the oven area free and clear of all combustibles such as paper, cardboard, and flammable liquids and solvents, as these materials may ignite and become a fire / safety hazard.
- NSF may require 6" clearance on the bottom and sides of the unit for cleaning. Do not place the oven on a curb base or seal to a wall. Please check with your local health code agencies to assure proper placement of your unit, as local codes may vary.
- Before making any utility connections to this oven, **check the rating plate** to be sure the oven specifications are compatible with the electrical services supplied for the oven. Please review all installation instructions, including page 7 that reviews electrical requirements and connection to power.

### ***VENTING YOUR OVEN***

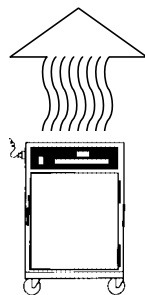

1. The purpose of ventilating hoods is to direct and capture smoke, grease-latent vapors, heat, odors, or fumes.
2. Low temperature equipment (defined as 'a unit with a maximum temperature 250°F or 120°C ') does not produce heat, odors, fumes, grease-laden vapors or smoke and is not required to be vented.
3. Most jurisdictions consider our low-temperature ovens (maximum temperature of 325°F / 160°C or 350°F / 175°C) as low-heat appliances not requiring vent hoods.
4. Installation must conform with local codes. The authority having jurisdiction of enforcement of the codes will have the responsibility for making interpretations of the rules.

# FWE LOW TEMPERATURE COOK & HOLD OVENS

## POWER SOURCE

### **ELECTRICAL REQUIREMENTS AND CONNECTION**

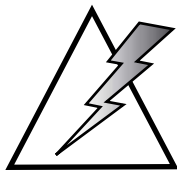

FWE Low Cook and Hold Oven models operate with a grounding cord plug for your protection against possible shock hazards. Be sure to plug only into a properly grounded three prong wall receptacle. If you have any questions with regard to adequate wiring or grounding in your building, a qualified electrician should be contacted before

using your cabinet. The amperage of your cabinet is stamped on the name plate attached to the unit.

THE INSTALLATION INSTRUCTIONS CONTAINED HEREIN ARE FOR THE USE OF QUALIFIED INSTALLATION AND SERVICE PERSONNEL ONLY. INSTALLATION OR SERVICE BY OTHER THAN QUALIFIED PERSONNEL MAY RESULT IN DAMAGE TO THE OVEN AND/OR INJURY TO THE OPERATOR.



Qualified installation personnel are individuals, a firm, a corporation, or a company which either in person or through a representative are engaged in, and responsible for the installation of electrical wiring from the electric meter, main control box or service outlet to the commercial or industrial equipment and is familiar with foodservice equipment.

Qualified installation personnel must be experienced in such work, familiar with all precautions required, and have complied with all requirements of state or local authorities having jurisdiction.

FWE CANNOT ASSUME RESPONSIBILITY FOR LOSS OR DAMAGE SUFFERED AS A RESULT OF IMPROPER INSTALLATION.

Wiring diagrams are located in the control compartment of the unit and in this manual. This oven is supplied with a 220 volt 20 amp rated cord / plug, located at the rear of the oven.

**WARNING!** This oven is equipped with a grounding type plug for your protection against shock hazard and should be plugged directly into a properly grounded receptacle. DO NOT cut or remove the grounding prong from this plug.



### **HARDWIRE APPLICATIONS**

#### **WARNING! Risk of Electrical Shock**

Should the oven have casters and be ordered for hardwire electrical connection for permanent connection, a cable restraint is required to limit oven movement.

Oven must be secured to building structure.

Preferred installation: Cable restraint is approximately six (6) inches shorter than flexible conduit. Secure cable restraint to building stud. Do not attach to drywall only.

# **FWE LOW TEMPERATURE COOK & HOLD OVENS**

## **INSTALLING THE CABINET**

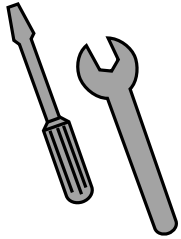

1. After uncrating your cabinet, remove all packing materials from inside the cabinet, remove all tape, zip-ties, and padding which held all doors, shelves, racks, cord, etc., in place during shipment.
2. Install the cabinet interior (pan slides).
3. No vent hood required - check local code. (See page 6.)
4. Proper connect power cord into wall receptacle. (See page 7.)

**CAUTION!** IF YOU ARE UNSURE IF YOU HAVE PROPER OR ADEQUATE WIRING, AMPERAGE, OR GROUNDING. A QUALIFIED ELECTRICIAN SHOULD BE CONTACTED BEFORE ATTEMPTING HOOK-UP OR OPERATION.

### **INSTALLATION SAFETY**



### **WARNINGS:**

- ▲ Installation should be reviewed by properly qualified personnel prior to turning on appliance for first time. Qualified installation personnel must be experienced in such work, familiar with all precautions required, and have complied with all requirements of state or local authorities having jurisdiction.
- ▲ When oven is in operation, or when just turned OFF, the unit will be hot. Use care not to burn yourself and never touch or attempt to adjust tray/pan slides, remove or adjust uprights or air tunnel until tunnel has cooled!
- ▲ Only a qualified electrician should attempt service/repair of unit.
- ▲ Always make sure power is "OFF" and the unit is unplugged prior to removal of control panel.

Installation must conform with all Local and National installation standards. Local installation codes and / or requirements may vary. If you have any questions regarding the proper installation and / or operation of your oven, please contact your local distributor. If you do not have a local distributor, please call your local FWE representative, government agency, qualified electrical contractor or Health Department to verify your local standards.

### **MOVING THE OVEN**

If oven needs to be moved for any reason:

1. Allow proper "COOL DOWN" time for control panel (15 minutes to 30 minutes).
2. Disconnect power plug.
3. Reconnect power cord only in to a proper outlet (see installation instructions).

### **IN CASE OF POWER FAILURE**

- Turn power switch to "OFF"
- Do not attempt to operate the oven until the power is properly restored and is constant.
- Avoid using in stormy weather, as with any electrical appliance.
- Allow a five (5) minute rest after electricity is restored prior to attempting a restart.



# **FWE LOW TEMPERATURE COOK & HOLD OVENS**

## **INTRODUCTION**

### **FOR YOUR SAFETY - PLEASE NOTE :**

THE INFORMATION CONTAINED IN THIS SECTION IS PROVIDED FOR THE USE OF QUALIFIED OPERATING PERSONNEL. QUALIFIED OPERATING PERSONNEL ARE THOSE WHO HAVE CAREFULLY READ THE INFORMATION CONTAINED IN THIS MANUAL AND ARE FAMILIAR WITH THE FUNCTIONS OF THE OVEN AND / OR HAVE PREVIOUS EXPERIENCE WITH THE OPERATION OF THE EQUIPMENT DESCRIBED. ADHERENCE TO THE PROCEDURES RECOMMENDED HEREIN WILL ASSURE THE ACHIEVEMENT OF OPTIMUM PERFORMANCE AND LONG, TROUBLE-FREE SERVICE. Please take the time to read the following safety and operating instructions. They are the key to the successful and safe operation of your FWE oven.



## **FWE Low Temperature Cook and Hold Oven With An Automatic Hold Cycle**

With an FWE Low Temperature Low Cook and Hold Oven, you receive unequalled performance in any high-volume foodservice operation, especially in satellite locations where kitchen space and staff levels are minimal. FWE ovens quickly reach preset temperatures and can quickly recover after doors have been opened.

Simple to use manual controls take the guess work out of food preparation. Door vents allow excessive humidity to be released during cook cycle and cabinet temperature can be quickly adjusted to holding temperature.



LCH-18



CONTROL PANEL  
OFFERS  
CHOICE  
OF COOKING BY  
PRODUCT PROBE  
OR TIME



LCH-4



LCH-10



LCH-6/6S

# FIVE LOW TEMPERATURE COOK & HOLD OVENS

## INITIAL STARTUP & OPERATING INSTRUCTIONS

### HOW TO GET STARTED:

#### Initial start-up for first-time operation.

A new oven needs to burn-off factory oils and polish before its first use. Do not load food into oven until this has been done.

### TURN ON MAIN POWER SWITCH.

(Be sure unit is connected to power source meeting proper electrical requirements.)

Control Panel will light and display message **"OFF"**.

### "COOK BY TIME" CYCLE:

Control must display the **"OFF"** mode to begin a selection.



PRESS "STOP CYCLE" KEY ONCE.



COOK BY  
TIME

PRESS THE "COOK BY TIME" KEY ONCE.

- SELECT COOK TIME by rotating **Knob "A"** to desired time (HR:MIN).
- SELECT COOK TEMPERATURE by rotating **Knob "B"** to desired temperature.
- SELECT HOLD TEMPERATURE by rotating **Knob "C"** to desired temperature.



PREHEAT  
to READY

PRESS "START/PAUSE" KEY to start the **PREHEAT CYCLE "PRHE"**.

The PREHEAT indicator will light and begin the PREHEAT CYCLE untimed. **"PRHE"** message will display.

At the end of the PREHEAT CYCLE, the control will beep and **"RDY"** ("Ready") message will display.

#### LOAD CABINET WITH FOOD PRODUCT.



START COOK  
BY TIME

PRESS "START/PAUSE" KEY to start **COOK BY TIME** CYCLE. The indicator will light. Timer **"##:##"** (HR:MIN) will display and begin countdown. When oven reaches the designated COOK TIME, the indicator light will go off. The oven will automatically switch to the "HOLD" mode after the COOK TIME duration.

NOTE: TO  
BYPASS  
PRE-HEAT,  
PRESS START  
TWICE.

### "COOK BY PROBE" CYCLE:

**CONNECT PROBE INTO SOCKET** (inside cabinet: top, upfront).

Place PROBE TIP outside cabinet and close cabinet door.

**TURN ON MAIN POWER SWITCH.**

Set up cooking perimeters as shown below.

Control must display the **"OFF"** mode to begin selection.



PRESS "STOP CYCLE" KEY ONCE.

PRESS "COOK BY PROBE" KEY ONCE.



COOK BY  
PROBE

- SELECT PROBE TEMPERATURE or *desired product internal temperature* by rotating **Knob "A"**.
- SELECT CABINET OR COOKING TEMPERATURE by rotating **Knob "B"**.
- SELECT HOLD TEMPERATURE by rotating **Knob "C"** to desired *cabinet temperature*.



PREHEAT  
to READY

PRESS "START/PAUSE" KEY to start the **PREHEAT CYCLE**.

The Pre-Heat indicator light will light and begin the Pre-Heat Mode untimed. **"PRHE"** message will display. At the end of the Pre-Heat Cycle, the control will beep and **"RDY"** ("Ready") message will display.

#### LOAD CABINET WITH PRODUCT.

**PLACE PROBE TIP INTO CENTER OF PRODUCT.**



START COOK  
BY PROBE

PRESS "START/PAUSE" KEY to start the **COOK BY PROBE CYCLE** and the indicator is lighted. The *product internal temperature "###"* will be displayed. When probe reaches the designated *product internal temperature*, the indicator light will go off and the oven will automatically switch to the "HOLD" mode.

### FAHRENHEIT or CELSIUS Temperature Scale:

While unit is "ON", press and hold the "START/PAUSE" KEY for five (5) seconds.

The display will read **"dgF"** for Fahrenheit or **"dgC"** for Celsius. Press and hold to change scale.

**Fahrenheit Temperature Range:** 100°F to 350°F

**Celsius Temperature Range:** 38°C to 177°C

# FWE LOW TEMPERATURE COOK & HOLD OVENS

## INITIAL STARTUP & OPERATING INSTRUCTIONS

CONTROL PANEL OFFERS CHOICE OF COOKING BY TIME OR PRODUCT PROBE

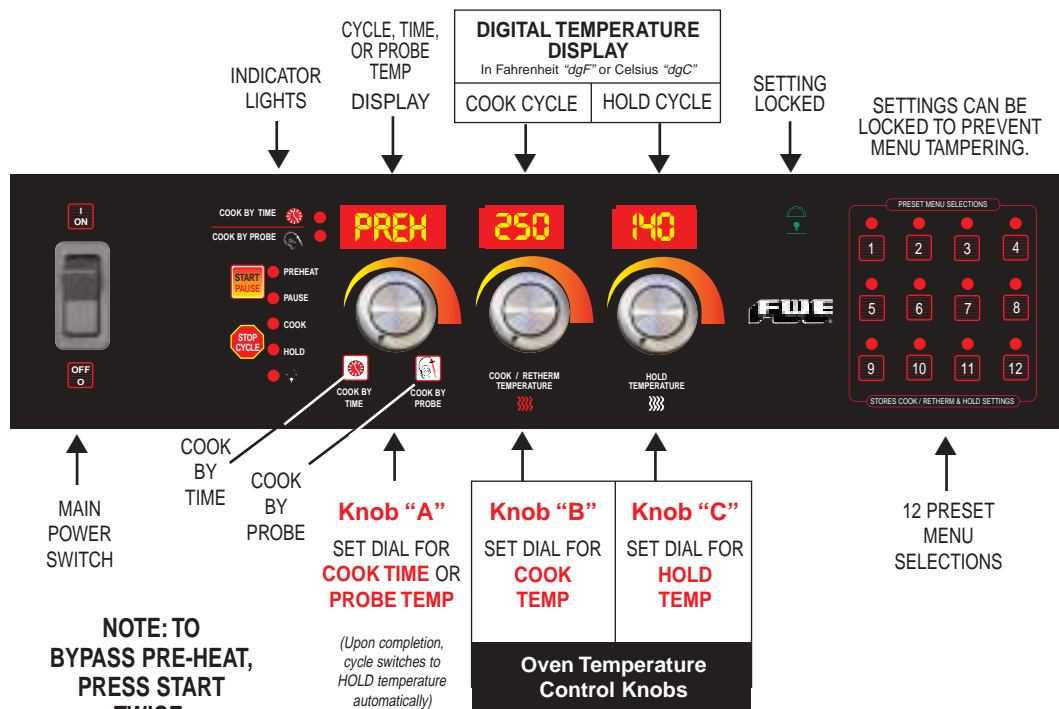

**NOTE:**  
**Pre-Heat Oven for 30 Minutes.**  
 At the end of the Pre-Heat Cycle "PRHE", the control will beep and "RDY" ("Ready") message will display.  
**PRESS**  
 "START/PAUSE" KEY  
 to start the **COOK CYCLE.**

**NOTE: TO BYPASS PRE-HEAT, PRESS START TWICE.**

*(Upon completion, cycle switches to HOLD temperature automatically)*

Note: Pre-Heating Oven Required for 30 minutes.  
**COOK CYCLE** does not begin until oven operating temperature is reached.

"PRHE" message displays during Pre-Heat.

"RDY" ("Ready") message will display when operating temperature is reached.

PRESS "START/PAUSE" KEY to start the "COOK BY TIME" Cycle or "COOK BY PROBE" Cycle.



**LOCK (OR UNLOCK) YOUR CURRENT OVEN SETTING:**  
 PRESS THE **HIDDEN KEY** UNTIL YOU HEAR THE AUDIBLE SOUND. PRESS THE **COOK BY TIME** KEY FIRST, FOLLOWED BY THE **COOK BY PROBE** KEY SECOND, AND FINALLY THE **COOK BY TIME** KEY AGAIN. INDICATOR WILL LIGHT IN LOCKED SETTING.



**NOTE:** Cooling fans will run to ventilate the heat from behind the control panel area, as long as the Power Switch is in the "ON" position. Allow proper cool down periods of 1/2 hour after cooking *before* turning unit "OFF" or disconnecting.

**FWE Customer Service and Support:**  
 815 459 7500

P. O. Box 1001 • Crystal Lake, IL 60039-1001  
 FAX: 815 459 7989

**IMPORTANT:** Your **Manufacturer Registration Card** must be returned within 30 days after initial delivery to activate the warranty.

### PRESET MENU SELECTIONS



**TO STORE COOKING PERIMETERS:**  
 PRESS MENU KEY FOR 5 SECONDS.

**SELECT THE COOK TIME, COOK TEMP, & HOLD TEMP OR PROBE TEMP, COOK TEMP, & HOLD TEMP.**

**PRESS THE MENU KEY AGAIN TO STORE THE SELECTED SETTINGS.**

**STORE UP TO 12 MENU SELECTIONS.**

# ***FIVE LOW TEMPERATURE COOK & HOLD OVENS***

## ***GENERAL CLEANING AND MAINTENANCE***

**HAZARD OF INJURY OR BURN!** ALLOW CABINET TO COOL BEFORE CLEANING. Use care not to burn yourself and never touch or attempt to adjust tray/pan slides, remove or adjust uprights or air tunnel until tunnel has cooled! **WARNING:** Always disconnect the appliance from the power supply before servicing or cleaning.

### **HELPFUL HINTS:**

- Place a sheet pan one-half full of water in the bottom rack position. The water evaporates, increasing humidity in the oven, and the pan will catch spills, grease, and drippings during operation.
- Wipe off spills as soon as possible.
- Clean regularly to avoid heavy dirt build-up.

Keep your cabinet clean by simply wiping the interior and exterior, as needed, with a damp cloth or sponge and a mild soapy solution. **NEVER USE ABRASIVES, ACIDS, OR STRONG CLEANERS.** Do not flood or allow electrical parts to become wet. A stainless steel cleaner/polish is recommended for the exterior to maintain a "like-new" appearance.

### **DO NOT USE WAX OR STRONG CLEANERS ON DOOR GASKETS OR VINYL TRIM.**

1. Use the mildest cleaning procedure that will do the job.
2. Always rub in the direction of polish lines to avoid scratching the surface.
3. Use only a soft cloth, sponge, fibrous brushes, plastic or stainless steel pads for cleaning and scouring.
4. Rinse thoroughly with fresh water after every cleaning operation.
5. Always wipe dry to avoid water marks.

	<b>SOIL</b>	<b>CLEANER</b>	<b>METHOD</b>
<b>CABINET CLEANING</b>  Inside and Outside  Stainless Steel Cleaning	Routine Cleaning	Soap, ammonia or detergent* and water	1. Sponge on with cloth 2. Rinse
	Stubborn Spots, Stains	Mild abrasive made for Stainless Steel	1. Apply with damp sponge or cloth 2. Rub lightly
	Burnt on Foods or Grease	Chemical oven cleaner made for Stainless Steel	Follow oven cleaner manufacturer's directions
	Hard Water Spots & Scale	Vinegar	1. Swab or wipe with cloth 2. Rinse and dry
	Heat tint or Heavy discoloration	Non-Toxic Commercial Oven Cleaner	Follow manufacturer's directions
<b>Door Seal</b>	Routine Cleaning	Use warm water and dry immediately. Allow door seal to completely dry before using.	

\*Mild detergents include soaps and non-abrasive cleaners.

# **FWE LOW TEMPERATURE COOK & HOLD OVENS**

## **GENERAL CLEANING AND MAINTENANCE**

### **Cleaning the Oven**

Stainless steel ovens may be kept clean and in good condition with a light oil.

- Unplug the unit from the power source.
- Remove the racks and rack supports.
- Saturate a cloth, and wipe the oven when it is cold.
- Dry the oven with a clean cloth.

### **Preventative Maintenance**

- Proper clearance and ventilation to cool the motors. *(See oven location on page 6.)*
- A program for routinely cleaning oven.
- Clean vent louvers and holes.
- Do not flood or allow electrical parts to become wet.
- Remove interior tray slide assemblies for full cleaning.
- A stainless steel cleaner / polish is recommended for the exterior to maintain a “like-new” appearance.

### **Maintenance**

If maintenance or repairs are required, contact your local service company, a factory representative or the FWE company.

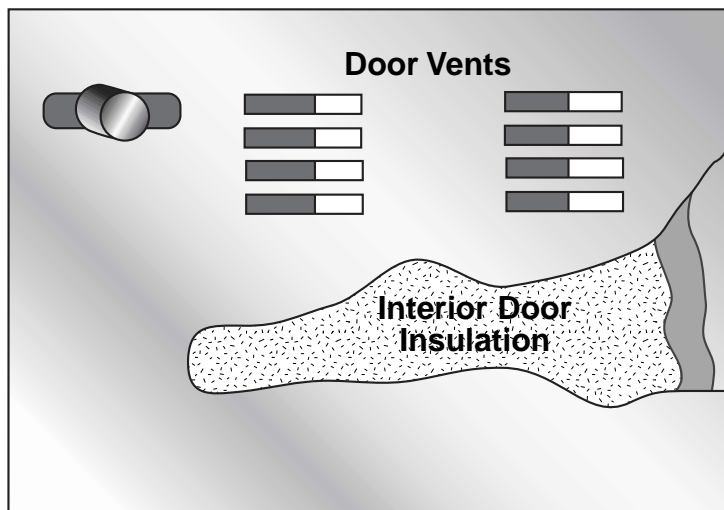

**USE  
CAUTION  
WHEN  
CLEANING  
AROUND  
DOOR  
VENTS.**

### **CAUTION:**

Because of the door vents, when cleaning the door, wipe down interior liner to remove grease or foods, but do not submerge or saturate the insulation in the door pan. This will cause damage to the door insulation.

# ***FWE LOW TEMPERATURE COOK & HOLD OVENS***

## ***FOOD SAFETY AND COOKING***

### ***DISCLAIMER***

Food safety is of paramount importance in any kitchen and proper steps should always be taken to assure “Safe Food Practices”. As a helpful guide, FWE has compiled the following information for your review and use. Though the information in this guide is deemed reliable and up-to-date, food safety is always being updated. This information should be used with a complete, ongoing safety program (HACCP, Food Safety Course), and in accordance with your local health department.

**DISCLAIMER:** The information provided in this booklet has been compiled from sources and documents deemed to be reliable and represent the best judgement of Food Warming Equipment Company, Inc. The accuracy of the information is not guaranteed, however, nor is any responsibility assumed or implied by FWE for any damage or loss resulting from inaccuracies, errors or omissions. Food safety laws change frequently and may vary by city, county, or state. Food Service Operators and Consultants are urged to keep informed of all regulations and safe food practices as well as develop food safety-related policies and procedures as part of their commitment to employee and customer safety. Use the advice and guidance of legal counsel. This booklet is not intended to provide legal advice.

### ***FOOD SAFETY & COOKING***

Most foods are at risk during preparation and service. As foods are thawed, cooked, held, served, cooled and reheated, they may pass several times through the **temperature danger zone** of 40°F to 140°F (4.4°C to 60°C). Each time food is handled, it runs the risk of cross-contamination from other food and from food-contact surfaces, such as: human hands, cutting boards, and utensils. It is recommended that passing through the 40°F to 140°F (4.4°C to 60°C) zone be done as quickly and infrequently as possible.

### ***THE “FOUR HOUR” RULE***

The **temperature danger zone** is considered 40°F to 140°F (4.4°C to 60°C) and **rapid bacteria growth zone** is considered 70°F to 120°F (21°C to 49°C). Prevent potentially hazardous foods from spending more than four (4) hours combined total time in these zones. The exposure time is accumulative from time of receiving products until time it is cooked. Exposure time begins again when food is fully cooked, held, served, cooled, and reheated. **FOOD SHOULD NEVER BE REHEATED TWICE!**

### ***FOOD SAFETY***

Food and public health dangers can be avoided with proper food handling, storage, cooking (rethermalizing) and holding methods. The key to foodborne illness prevention is constant monitoring of food temperatures (both storage and internal).

### ***PROPER FOOD HANDLING - HACCP OVERVIEW***

HACCP is a Food Safety Program that is an effective tool for safety and quality of food, from processing, receiving, storage, cooking, holding and serving. By definition, HACCP is:

**“HAZARD ANALYSIS CRITICAL CONTROL POINT.”**

# FIVE LOW TEMPERATURE COOK & HOLD OVENS

## FOOD SAFETY AND COOKING

### SEVEN STEP HACCP FOOD GUIDELINE

Effective use of HACCP Guidelines will assure food protection. There are seven (7) steps in HACCP.

1. Assessment
2. Steps or points of control
3. Failure mode analysis
4. Employee procedures
5. Corrective action
6. Record keeping
7. Verification

There are twelve (12) common conditions that support the growth of bacteria in food. Thus, all twelve (12) critical control points should be monitored to assure food safety.

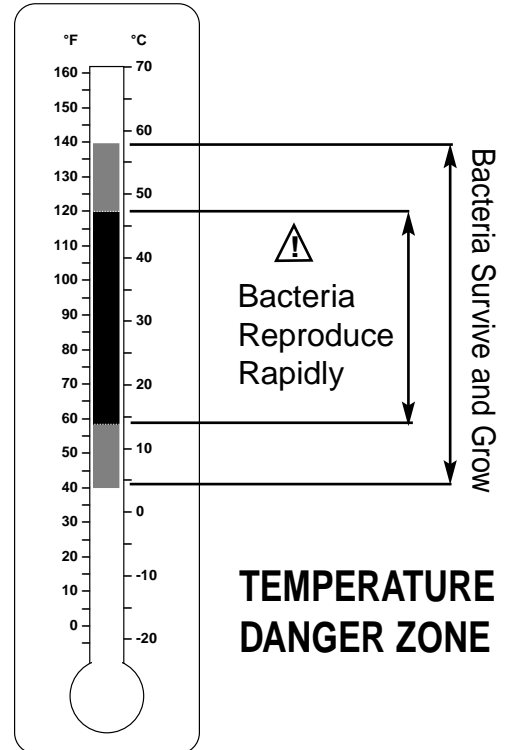

### CRITICAL CONTROL POINTS TO ELIMINATE BACTERIA - Table A

CRITICAL POINT	MONITORED TEMPERATURE	MONITORED TIME
1. Receive food	less than 40°F (5°C)	
2. Dry - Storage	50°F (10°C) to 70°F (21°C) with 50% - 60% relative humidity	
3. Store refrigerated food	best: 35°F (2°C), or less than 40°F (5°C)	within 7 days max
4. Store deep-chill food	26°F (-3°C) to 32°F (0°C)	
5. Store frozen food	less than 0°F (-18°C)	
6. Thaw food	less than 40°F (5°C) or under water 70°F (21°C) or lower	within 2 hours
7. Prepare food <sup>1</sup>	generally less than 50°F (10°C)	
8. Cook food	proper internal temperature*	see pages 4 and 6
9. Hold food	hot food greater than 140°F (54°C) cold food less than 40°F (5°C)	
10. Serve food	hot food greater than 140°F (54°C)** cold food less than 40°F (5°C)**	
11. Cool food and leftover food Two proper cooling methods [a] and [b]	[a] maximum 6 hours, broken down as: • from 140°F (60°C) to 70°F (21°C) • from 70°F (21°C) to 41°F (5°C) or below [b] cooled to 41°F (5°C) or lower	2 hours or less 4 hours or less within 4 hours or less
12. Retherm leftover food	minimum of 165°F (74°C) for 15 sec	within 2 hours

<sup>1</sup> Depends upon product.

\* Must pass from 40°F (5°C) through 140°F (60°C) in 2 hours or less. See **Table E** on page 17 and **Minimum Cooking Times** on page 19.

\*\* Serve or discard all food within four (4) hours from the time it was removed from temperature control.

# ***FIVE LOW TEMPERATURE COOK & HOLD OVENS***

## ***FOOD SAFETY AND COOKING***

### ***PROPER STORAGE***

Refrigerator and freezer storage temperature should be monitored frequently.

- The optimal **refrigerator** temperature is 32°F to 35°F (0°C to 2°C) and always less than 40°F (5°C).
- The optimal **freezer** temperature less than 0°F (-18°C).

Product shelf life will vary depending upon such factors as how the product was processed, stored and transported prior to your reception, as well as the quality of the products itself. The following is the typical storage shelf life of common food products.

### ***STORAGE SHELF LIFE - Table B***

<b>PRODUCT</b>	<b>REFRIGERATOR * 35°F (2°C)</b>	<b>FREEZER * -1°F (-17.2°C)</b>	
Ground Beef	1-2 days	1-3 months	
Ground Veal	1-2 days	1-3 months	
Ground Pork	1-2 days	1-3 months	
Fresh Beef	3-6 days	6-9 months	
Fresh Veal	3-6 days	6-9 months	
Fresh Pork	3-6 days	6-9 months	
Poultry	1-2 days	6 months	SEE TABLES C & D FOR MORE INFO
Fish	1-2 days	3 months	
Shellfish	1-2 days	2-3 months	
Vegetables	5-7 days	6-8 months	

\*Store product at a very constant temperature for best results.

### ***STORAGE SHELF LIFE OF CHICKEN - Table C***

<b>TEMPERATURE*</b> *See Table D for more information	<b>TIME (DAYS)</b>	<b>BACTERIA COUNT</b> Per square centimeter bacteria count in Chicken	<b>CONDITION</b>
41°F (5°C)	0	360	OK
41°F (5°C)	1	5,800	All Right
41°F (5°C)	2	92,000	Questionable
41°F (5°C)	3	1,475,000	Suspect
41°F (5°C)	4	23,600,000	DO NOT SERVE



# ***FIVE LOW TEMPERATURE COOK & HOLD OVENS***

## ***FOOD SAFETY AND COOKING***

### ***BACTERIA GROWTH ON CHICKEN - Table D***

<b>BACTERIA COUNT WILL DOUBLE IN: TEMPERATURE</b>	<b>TIME (HOURS)</b>
0°F (-18°C) 32°F (0°C)	- NEGLIGIBLE- 20 hrs
40°F (5°C)	6 hrs
50°F (10°C) 60°F (16°C) 70°F (22°C)	3 hrs 2 hrs 1 hr

### ***MINIMUM SAFE INTERNAL COOKING TEMPERATURES - Table E***

<b>PRODUCT</b>	<b>INTERNAL TEMPERATURE</b>	<b>TIME</b>
<b>Poultry, stuffing, stuffed meat, stuffed pastas</b>	165°F (73.9°C) Cook stuffing first, then stuff the food	for 15 seconds
<b>Ground meats (including ground beef and ground pork)</b>	155°F (68.3°C) 150°F (65.6°C) 145°F (62.8°C)	for 15 seconds for 1 minute, or for 3 minutes, or
<b>Pork, game animals, comminuted fish and meats, injected meats, and eggs in multi-serving batches</b>	155°F (68.3°C) 150°F (65.6°C) 145°F (62.8°C)	for 15 seconds, or for 1 minute, or for 3 minutes
<b>Beef roasts</b>	145°F (62.8°C) 140°F (60°C) 135°F (58°C) 130°F (54.4°C)	for 3 minutes, or for 12 minutes, or for 32 minutes, or for 121 minutes
<b>Beef steaks</b>	145°F (62.8°C)	for 15 seconds
<b>Fish, seafood, beef (cubes, slices, etc.), veal, lamb, mutton, shell eggs for immediate service</b>	145°F (62.8°C)	for 15 seconds
<b>For a customer's order, and all other potentially hazardous foods not listed in this table</b>	145°F (62.8°C)	for 15 seconds

# FIVE LOW TEMPERATURE COOK & HOLD OVENS

## FOOD SAFETY AND COOKING

### “QUICK REFERENCE OUTLINE: FROM PREPARATION TO SERVE”

**REMEMBER: KEEP HOT FOOD HOT AND COLD FOOD COLD!**

- Refrigerate foods before preparation.
- Run refrigerator or freezer 1° or 2° lower than desired product temperature.
- Prepare small batches of food no further in advance than necessary. Return them to the refrigerator before cooking or serving.
- Use sanitized cutting boards and knives to avoid cross-contamination.
- Wash fruits and vegetables in sinks used only for food preparation.
- Recipe instructions for cooking should specify cooking times and end product internal temperatures.
- Cook foods to higher than their minimum safe internal temperatures if their quality will not be compromised.
- Measure food temperatures with a thermocouple or thermometer, accurate to  $\pm 2^{\circ}\text{F}$  or  $\pm 1^{\circ}\text{C}$ . Never rely on a “best guess”, “experience”, or equipment (such as oven) thermometers.
- Measure internal food temperatures in several places. Clean and sanitize thermometers before and after each use.
- Avoid overloading cooking surfaces and ovens. The unit’s temperature may drop or foods may spill on each other.
- Allow the temperature of cooking equipment to return to required temperatures between batches.
- Correctly taste food.
- Hold hot foods higher than  $145^{\circ}\text{F}$  ( $62.8^{\circ}\text{C}$ ).
- Hold cold foods lower than  $41^{\circ}\text{F}$  ( $5^{\circ}\text{C}$ ).
- Prevent potentially hazardous foods from spending more than four (4) hours total in the *temperature danger zone*.

### COOLING METHOD DANGER ZONES

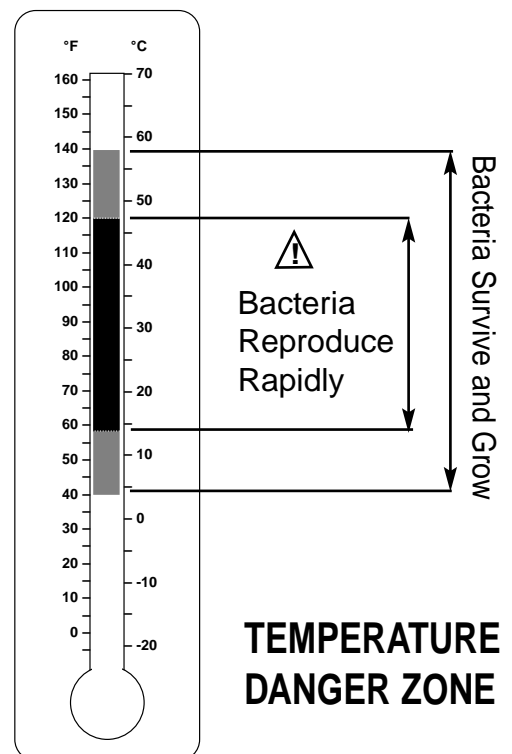
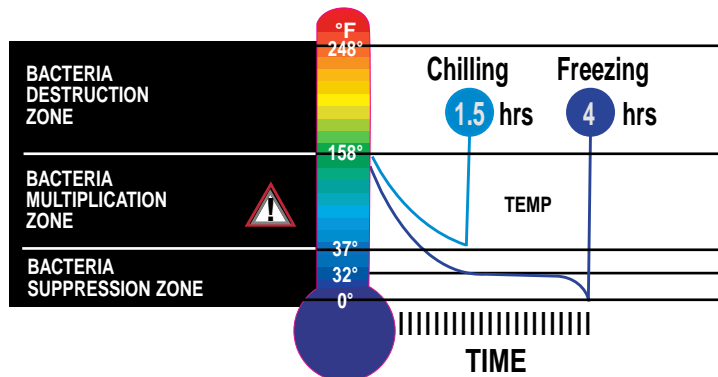

# ***FWE LOW TEMPERATURE COOK & HOLD OVENS***

## ***FOOD SAFETY AND COOKING***

### ***MINIMUM COOKING TIMES***

In order for food to be properly pasteurized, bring bacteria and pathogens to a safe range, foods must be cooked to proper internal temperature (T1), and held at the minimum correct length of time (T2), to be considered SAFE.

<b>GENERAL FOODS</b> (T1) x (T2)		<b>FISH, MEAT, PORK &amp; GAME</b> (T1) x (T2)	
<b>INTERNAL TEMPERATURE</b>	<b>HOLD TIME</b>	<b>INTERNAL TEMPERATURE</b>	<b>HOLD TIME</b>
165°F (73.9°C)	15 seconds	145°F (62.8°C)	3 minutes
150°F (65.6°C)	1.21 minutes	150°F (65.6°C)	1 minute
140°F (60°C)	12.1 minutes	155°F (68.3°C)	15 seconds
130°F (54°C)	121 minutes	158°F (70°C)	< 1 second

### ***WATER CONTENT OF FOOD***

The majority of foods are composed predominately of water (See Table F). The water (or moisture content) is either inherently static or non-static. Non-static water contents is the moisture that will leave (or dehydrate) the product first, either by “evaporating”, “boiling off”, or “squeezed-out” of the food product. It is the non-static water content that typically defines what the customers (consumer) bases their perception of “Food Quality / Texture” of the finished product.

**The lower** the temperature food is cooked and / or rethermalized, **the less** “boiling off” of the internal moisture (juices). **The higher** the temperature food is cooked and / or rethermalized, **the greater** the amount of “boiling off” of internal moisture. The greater the amount of moisture retained in most food products, the product will tend to be more tender and tend to have better food texture.

Meat is approximately 70% - 80% water content, and will begin to “shrink” well below the boiling point (212°F / 100°C) because the collagen connective fibers found in all meat products will start to contract (shrink) at approximately 130°F (55°C) to 145°F (63°C). The shrinking collagen effectively starts to “squeeze-out” moisture content from within the product.

# **FWE LOW TEMPERATURE COOK & HOLD OVENS**

## **FOOD SAFETY AND COOKING**

Though cooking at lower temperatures for longer periods of time offers some advantages for consideration, always make sure that:

- A. Foods pass through temperature danger zones within proper time requirements<sup>1</sup>, and**
- B. Foods are cooked / rethermalized to proper internal temperatures<sup>2</sup>, and**
- C. Foods are held for the minimum correct length of time at that temperature<sup>3</sup>.**

1] Must pass from 40°F (5°C) through 140°F (60°C) in two hours or less.

2] See *Internal Temperature Chart* on page 17.

3] See *Internal Temperature Chart* on page 17 and *Minimum Cooking Times* on page 19.

### **WATER CONTENT OF FOOD - Table F**

<b>MEAT</b>	<b>WATER CONTENT</b>	<b>VEGETABLES</b>	<b>WATER CONTENT</b>
Beef	75%	Asparagus	90%
Chicken	75%	Carrots	85%
Fish	80%	Spinach	90%
Turkey	75%		
Veal	75%		

#### **References:**

1. Helpful information can also be obtained from the National Restaurant Association Education Foundation, including Safe Serving Information, and An International Food Safety Council. Contact the NRA at its websites or by phone at:  
[www.foodsafetycouncil.org](http://www.foodsafetycouncil.org)      [www.edfound.org](http://www.edfound.org)      ph: 312 / 715-1010
2. For the current Food Code, contact the FDA or its web site at <http://www.cfscan.fda.gov>. Also available is a summary listing of all changes made to the Food Code and the corresponding locations.
3. Please consult the following Government Control and Regulator Agencies:
  - USDA
  - USPNS
  - FSIS
  - FDA input based on CFP
  - State, Province, County, and City Health Departments
  - State, Province, County, and City Health Inspectors

**DISCLAIMER:** The information provided in this booklet has been compiled from sources and documents deemed to be reliable and represent the best judgement of Food Warming Equipment Company, Inc. The accuracy of the information is not guaranteed, however, nor is any responsibility assumed or implied by FWE for any damage or loss resulting from inaccuracies, errors or omissions. Food safety laws change frequently and may vary by city, county, or state. Food Service Operators and Consultants are urged to keep informed of all regulations and safe food practices as well as develop food safety-related policies and procedures as part of their commitment to employee and customer safety. Use the advice and guidance of legal counsel. This booklet is not intended to provide legal advice.

# FIVE LOW TEMPERATURE COOK & HOLD OVENS

## HELPFUL OPERATING TIPS

### Pans and Racks

Product or pan height determines how many racks are used. Greater product load will restrict the oven air flow which may result in longer cooking time, uneven baking or roasting. Load the oven from the bottom, centering the pans on the rack.

### Low Temperature Cooking and Holding

To reduce shrinkage when cooking / holding, place product directly on the racks. Place a sheet pan one-half full of water in the bottom rack position. The water evaporates, increasing humidity in the oven chamber. The pan catches grease from the meat, making oven cleaning easier. Equal distribution in the oven will assure best performance. Varying amounts of product will cause uneven baking results.

### Door Vents

Door vents are provided to allow for:

- A. Venting of excessive humidity in the oven, they may cause some products to become “soft” or “soggy”.
- B. When the oven switches from Cook to the Holding period, excessive heat in the unit may cause the product(s) to continue to “COOK”. The vents maybe opened to help reduces the internal temperature of the oven. Please see page 19 for additional information on typical water content of food.

### Cooking by Probe

Plug probe connector into socket located inside at the top of unit (see circled area). Close door leaving thermocouple outside of cabinet to keep handle cool to touch.



Location of Probe Socket



Turn on Main Power Switch. Press STOP CYCLE once. Press COOK BY PROBE. Select PROBE Internal Temperature (Knob A). Select COOK Cabinet Temperature (Knob B). Select HOLD Temperature (Knob C). **PREHEAT OVEN.** Control panel will beep. Load product and place probe into center of product. Press START. (*Operating Instructions detailed on Page 10.*)

# FIVE LOW TEMPERATURE COOK AND HOLD FEATURE

## APPROXIMATE COOK TIMES & TEMPERATURES

With the COOK & HOLD feature, products are roasted at lower temperatures for longer periods of time. This preserves flavor and tenderness and prevents over drying. There are three phases in cook and hold roasting.

- **Primary Cooking** - controlled by the COOK & HOLD TIMER , the product is cooked at a low temperature until approximately 2/3 done.
- **Cooking from stored heat** - when the primary cook time expires, the oven automatically switches to HOLD. The product continues to cook from the heat transferring through the product as well as the stored (latent) heat in the oven. Product must remain in the hold cycle for approximately 1-1/2 to 2 hours before being served. Use the probe or independent thermometer to assure food is done to correct internal temperatures.
- **Hold**—holds the product for several hours before serving with minimal loss of moisture or tenderness.

All meat should be completely thawed by refrigeration. Using frozen meat increases the cook time causing shrinkage.

Product	Cook Temp.	Hold Temp.	Quantity	Cook Time (Hrs)	Min. Hold Time (Hrs)	Total Time (Hrs)
Prime rib, bone cap off 14 – 18 lbs. (6.4 – 8.1 kg)	200°F 93°C	140°F 60°C	1 3	5 to 6 6 to 7	4 to 6 4 to 6	9 to 12 10 to 13
Prime rib, bone cap on 14 – 18 lbs. (6.4 – 8.1 kg)	200°F 93°C	140°F 60°C	1 3	6 to 7 7 to 8	6 to 7 6 to 7	12 to 14 13 to 15
Top or bottom rounds 20 – 22 lbs. (9.1 – 10.0 kg)	200°F 93°C	140°F 60°C	1 3	5 to 6 6 to 7	5 to 6 5 to 6	10 to 12 11 to 13
Pork roast or ham 10 – 12 lbs. (4.5 – 5.4 kg)	220°F 104°C	170°F 76°C	2 4	4 to 5 5 to 7	3 to 4 3 to 4	7 to 9 8 to 11
Turkey 20 – 22 lbs. (9.1 – 10.0 kg)	230°F 110°C	160°F 71°C	1 4	4 to 6 5 to 7	2.5 2.5	6.5 to 8.5 7.5 to 9.5
Leg of Lamb, bone in 8 – 10 lbs. (4.36 – 4.5 kg)	225°F 107°C	160°F 71°C	2 4	4 to 5 5 to 6	2 to 3 2 to 3	6 to 8 7 to 9

**NOTE:** Actual times and temperatures may vary considerably from those shown above. They are affected by weight of load, internal temperature of the product, recipe, electrical loads, type of pan and the calibration of thermostat. Should your recipe vary, write in your proven time and temperature for ready reference.

# TROUBLE-SHOOTING CHART

**Check this list first before you call for service...**

To avoid unnecessary cost and inconvenience, make a few simple checks before calling for service. As these most common problems are NOT covered under warranty, be sure you have followed the instructions in this manual and these basic “1, 2, 3” troubleshooting tips:

1. Is electrical cord plugged in?
2. Is the “On-Off” switch in the “On” position?
3. Is the fuse or circuit breaker okay?

PROBLEM / SYMPTOM	POSSIBLE CAUSE(S)	SUGGESTED REMEDY
<b>NO POWER TO OVEN</b>	Oven is not plugged in	Plug in electrical cord
	Switch is “OFF”	Turn switch “On” Wait 10 seconds
	Circuit breaker tripped*	Reset circuit breaker*
	Fuse blown*	Replace fuse at back of unit*
<i>If problem reoccurs, check proper breaker rating.</i>		
<b>OVEN TURNS OFF SUDDENLY</b>	High limit switch tripped behind control panel @ 210°F	Wait for temperature to drop before attempting to restart (May take up to 15 min.) Unit will automatically reset itself. Check to see if proper ventilation is being achieved and cooling motors are working.
<b>POWER TO UNIT BUT OVEN WILL NOT TURN ON</b>	Start / Stop key not pressed on the control panel	See 'Start-up Guide'
<b>POWER TO UNIT, BUT OVEN DOES NOT HEAT UP</b>	Temperature is set too low	Set desired cooking temperature and press start key
	The oven has not reached preheat temperature	Wait for oven to reach preheat temperature
	Start / Stop key not pressed on the control panel	See 'Start-up Guide'
<b>OVEN DOES NOT MAINTAIN COOKING TEMPERATURE</b>	Door is not latched properly or door has been opened too frequently	Close the door securely and latch
<b>GENERAL COOKING PROBLEM</b>	Check computerized controls: Incorrect menu selected	Program and select the appropriate menu selection
	Unable to change control settings	Menu selection is locked. <i>See page 11.</i>
<b>DISPLAY MESSAGES</b>	“noPR”	Probe is not connected or is not functioning.
	“dgF” “dgC”	<i>Degrees Fahrenheit</i> Temperature Scale <i>Degrees Celsius</i> Temperature Scale <i>See page 10 to change temperature scale.</i>
	“PREH”	<i>PREHEAT</i> Cycle; Blinking and beeping means oven has reached operating temperature. Press “START” key to enter into cook mode.

# FVE LOW TEMPERATURE COOK & HOLD OVENS

## GENERAL INTERNAL ELECTRICAL PARTS IDENTIFICATION

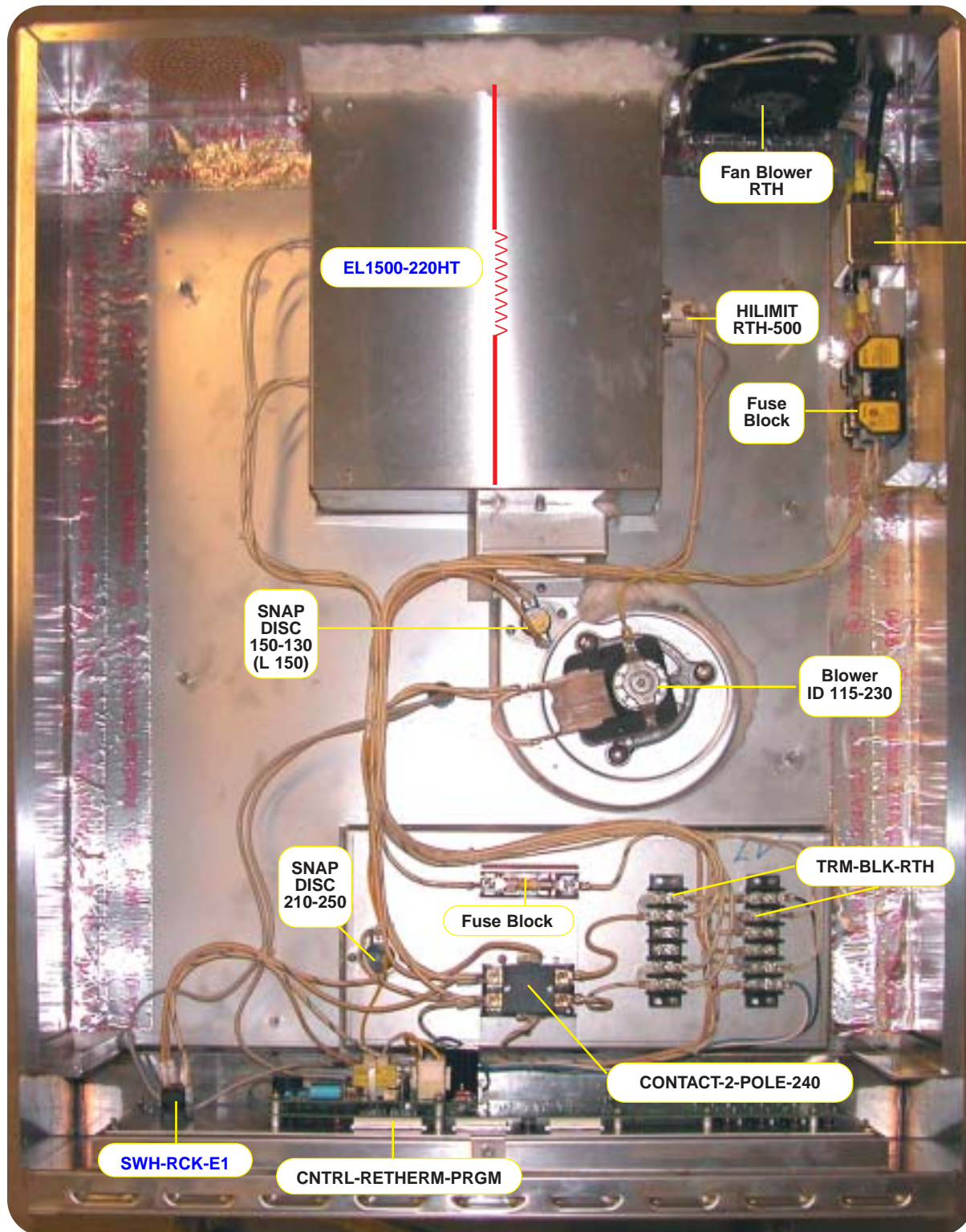



# FWE LOW TEMPERATURE COOK & HOLD OVENS: GENERAL INTERNAL ELECTRICAL PARTS IDENTIFICATION

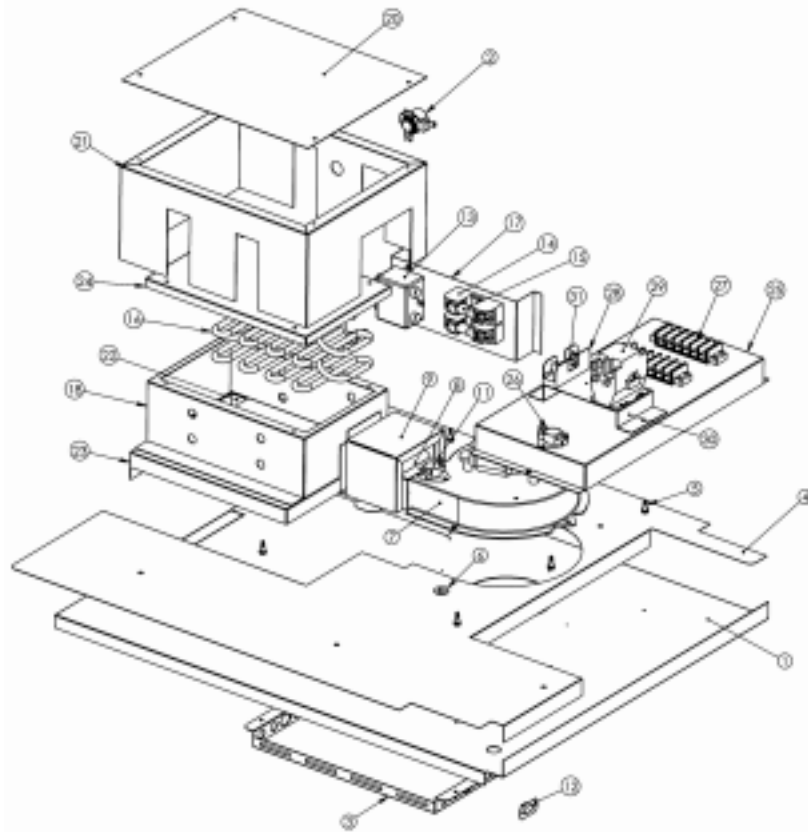

ITEM NO.	QTY.	PART NO.	DESCRIPTION
1	1	10141	LCH-18 INSIDE TOP
2	1	HUMIT-RTH	HI-TEMP SNAP DISC-RTH (500 DEG. F)
3	1	50655	LCH-1826-7 INTAKE BAFFLE
4	1	51744	LCH-18 TOP INSULATION HOLDER
5	6	510X.625-SD-T5#3	SCREW 10X5/8 HEX HEAD DRILL SELF-TAP
6	1	B5H-3-4	BUSHING SB125-16
7	1	BLWR-REV-115-230	BLOWER ASSEMBLY DUAL VOLT 115/230
8	1	52551	AIR TRANSFER FRONT END SHORT
9	1	51136	AIR TRANSFER FRONT INSULATION COVER
10	1	51136	AIR TRANSFER RECEIVER END
11	1	SNAP DISC 150-130	COOL DOWN SWITCH NO F150
12	1	52505	LCH THERMOSTAT MOUNTING BRACKET
13	1	FLTR-20A-20EK1	FILTER 20AMP TYCO 20EK1
14	2	FSHLD-30AMP-LCH	HKP FUSEHOLDER 30 AMP LCH
15	2	FS-FRN-R20	FUSE 20 AMP 250V RK5 TD FUSE
16	2	Z-600-1388	EL1500W 220V ELEMENT 4.5
17	1	52301	LCH-6 ENGLISH HAT CHANNEL
18	1	5528	OVEN ELEMENT BOX
19	1	51331	AIR RAMP
20	1	5537	OVEN ELEMENT BOX INSULATION SURROUND COVER
21	1	5811	ELEMENT BOX INSULATION SURROUND
22	1	5532	OVEN HEAT BOX BOTTOM INSUL BAFFLE
23	1	5534	OVEN ELEMENT BOX BOTTOM
24	1	5527	OVEN ELEMENT BOX COVER SIDE DISCHARGE
25	1	3206	OVEN COMPONENT PAD REVCOR
26	1	SNAP DISC 210-250	COOL DOWN SWITCH NO L250
27	2	TRM BLK RTH	TERMINAL BLOCK RTH
28	1	FSHLD-MID-30-I	HKP FUSEHOLDER 30 AMP LCH
29	1	Contact-2 Pole-240V-40AMP	Contact-2 Pole-120V-40AMP
30	1	50625	CONTACT-2 POLES MOUNTING PLATE
31	1	FS-LP-MID-10AMP	FUSE 10 AMP LOW PEAK MIDGET (LP-CC)

# FWE LOW TEMPERATURE COOK & HOLD OVENS

## WIRING DIAGRAM

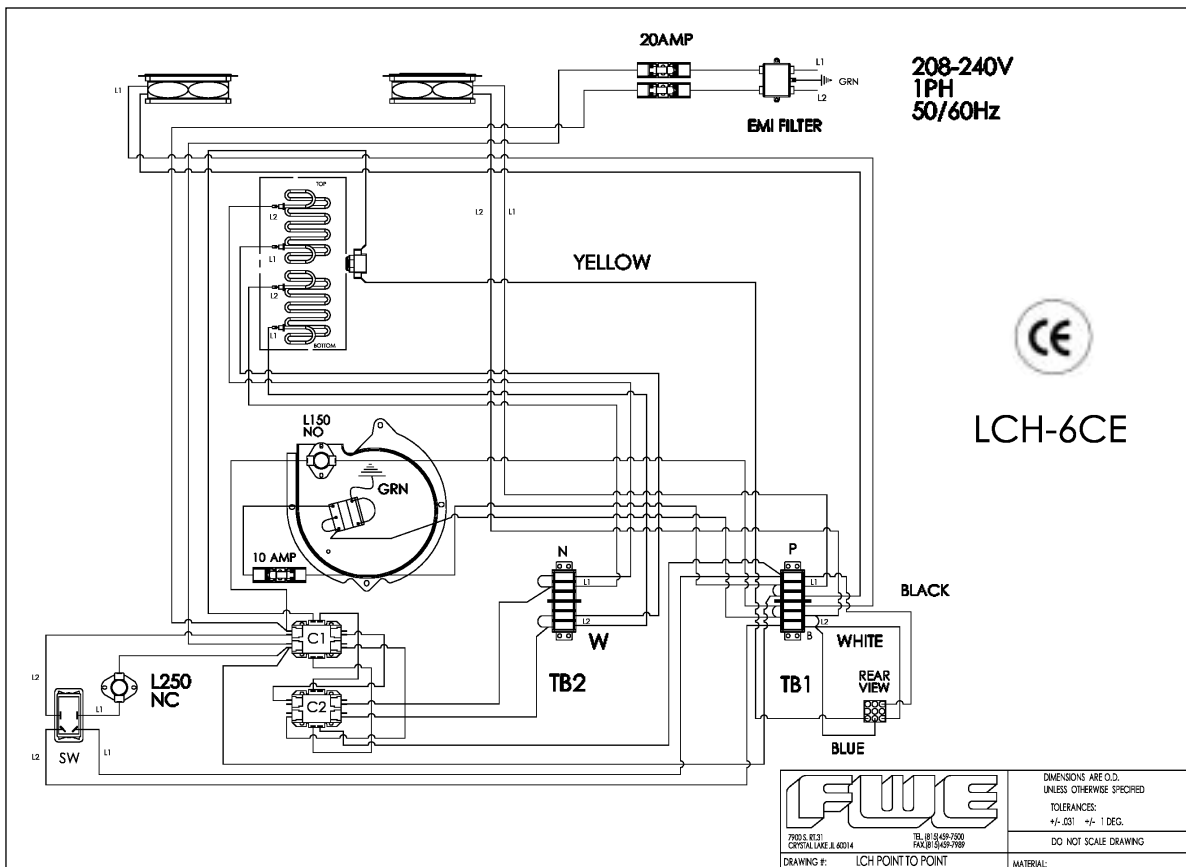
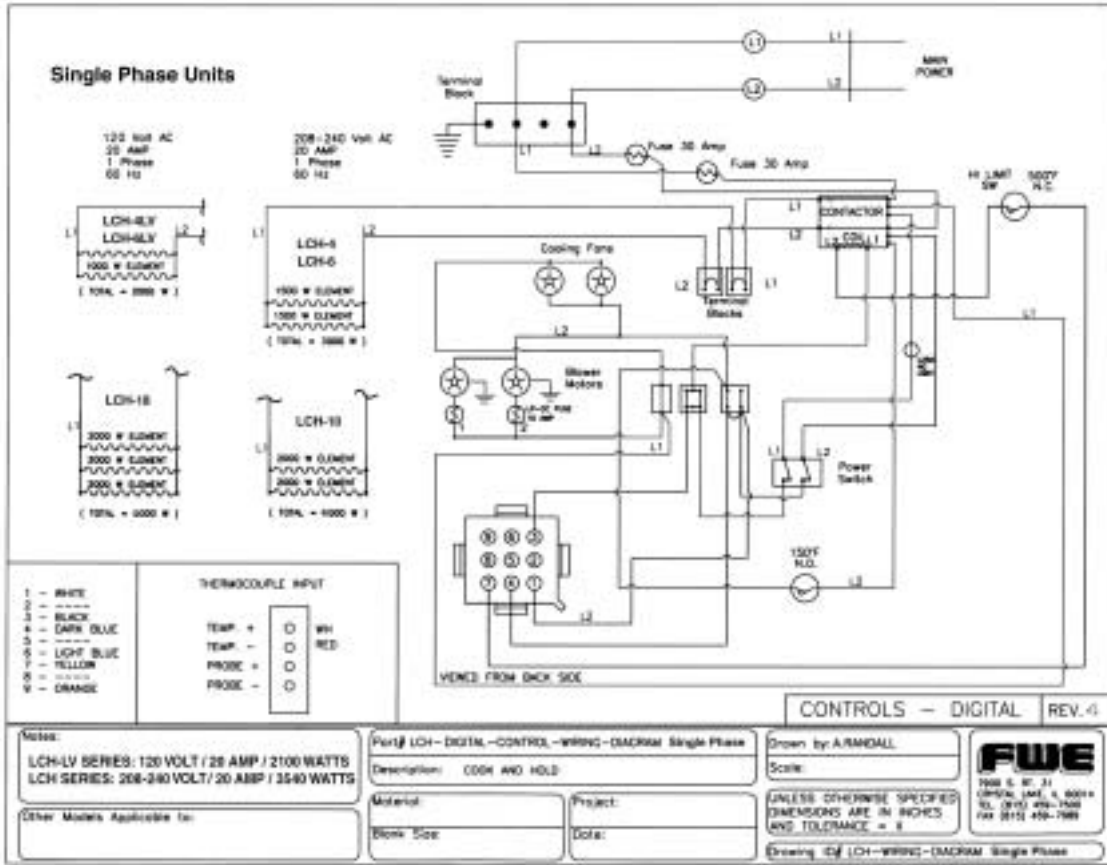

# **FWE LOW TEMPERATURE COOK & HOLD OVENS**

## **SERVICE RECORD**

**Model Number** \_\_\_\_\_

**Serial Number** \_\_\_\_\_

**Notes:** \_\_\_\_\_

**Date of Purchase** \_\_\_\_\_

---

---

---

---

---

---

---

---

---

---

---

---

---

---

---

---

---

---

---

---

---

---

---

---

---

---

### **REPLACEMENT PARTS LIST:**

<b>DESCRIPTION</b>	<b>PART NUMBER</b>
Door hinge	
Magnetic Door Latch	
Universal Tray Slides (pr)	
Recessed Hand Grips (pr)	
5" poly caster, rigid	CSTR 5 R-5
5" poly caster, swivel w/brake	CSTR 5 SB-5
Extension cord, 110 volt, 10'	
Extension cord, 220 volt, 10'	CRDSET 6-20P
Extension cord, 220 volt, 10'	CRDSET 6-50P
Extension cord, 220 volt, 10'	CRDSET 6-30P
Electronic Control Panel	CNTRL LCH
Control Panel Membrane	CNTRL PNL RHE1
Product Probe	
Drip Tray	
Shelf 18" x 27"	

# **FWE LOW TEMPERATURE COOK & HOLD OVENS**

## **LIMITED TWO YEAR WARRANTY**

**FWE / Food Warming Equipment Company, Inc.** (Seller) warrants to the original purchaser, subject to the exceptions and conditions below, that FWE manufactured equipment shall be free from defects in material or factory workmanship, under ordinary use for the purpose for which it is designed. The effective warranty period is as follows:

**PARTS:** Seller will furnish without charge to the original purchaser, FOB Sellers' factory, replacement parts for repairs to all new standard catalog products and factory custom / modified units, which in Seller's sole judgement, prove defective in materials or workmanship under normal and proper use with the reserved right to request the return of any part claimed to be defective, prior to issuing replacement part or authorizing warranty service, for a period of two (2) years from date of original shipment from Seller's plant, *except for equipment used in a **Correctional Environment / Facilities**, which is warranted for a period of one (1) year from date of original shipment from Seller's plant.*

**LABOR:** Seller's labor warranty shall be performed by a Seller-approved Service Agency who must contact Seller to obtain a Warranty Service Authorization (WSA) number prior to performing any repairs. If service is required during overtime periods, the difference between overtime and standard labor rates shall be paid by the purchaser. Seller does not assume any responsibility for any charges not expressly authorized, incidental to the repair or replacement of equipment covered by this warranty, nor charges exceeding, in Seller's sole judgement, normal and customary amounts. Only approved travel charges will be allowed. Seller's labor warranty shall be from the date of original shipment date from Seller's plant for a period of one (1) year, *except for equipment used in a **Correctional Environment / Facilities** which is warranted for a period of six (6) months.*

This warranty is for normal usage and does not apply to any product or parts thereof that have been misused, altered, or where Seller's operating instructions or specific voltage is not observed; nor shall this warranty apply to defective products or parts resulting from accident following date of original shipment, nor extend to or cover removal, installation, reinstallation or calibration, or service calls or cost of repairs undertaken by a customer. This warranty is also subject to the following:

- 1.] Customer returning the warranty registration card, accompanying Sellers original shipment, to Seller within thirty (30) days of receipt;
- 2.] Giving immediate notice of any allegedly defective part or product to Seller; and
- 3.] Customer, at Sellers request, returning said defective parts or product to Seller.

This is the sole warranty applicable to the merchandise. It is expressly understood that Seller's liability hereunder is limited to the repair or replacement, at Seller's option, of products or parts, defective materials or workmanship as provided above. Seller's judgement as to the cause and nature of any defect will be final. Seller shall in no case be responsible for special or consequential damages or any other obligation or liability with respect to products sold by Seller.

This warranty, as stated above, applies to equipment installed in the Continental United States. FWE equipment installed outside the Continental United States shall carry parts coverage only. All labor costs are approved on a discretionary basis, based on like repairs in the Continental U.S. This warranty shall stand in whole or in part as allowed by law. Any exclusion of a part of this warranty, as may be allowed by law, shall not void balance of warranty.

This is a limited warranty pursuant to the Consumer Product Warranties Act, 15 U.S. Code. section 2303.



Food Warming Equipment Company, Inc. • P. O. Box 1001 • 7900 S. Route 31 • Crystal Lake, IL 60039-1001  
sales@fweco.net Phone: 815-459-7500 Fax: 815-459-7989 www.fweco.com