

OPERATOR MANUAL

Part Number 121086 Rev. B

OM-CC-G and C/2-G

DOMESTIC

**MODEL: CC10-G, (2)CC10-G
C/2-20G, (2)C/2-20G
CONVECTION COMBO™
Combination Steamer-Oven**



C/2-20GF with
optional pan racks



(2)CC10-GF



THIS MANUAL MUST BE RETAINED FOR FUTURE REFERENCE. READ, UNDERSTAND AND FOLLOW THE INSTRUCTIONS AND WARNINGS CONTAINED IN THIS MANUAL.

FOR YOUR SAFETY

DO NOT STORE OR USE GASOLINE OR OTHER FLAMMABLE VAPORS AND LIQUIDS IN THE VICINITY OF THIS OR ANY OTHER APPLIANCE.

POST IN A PROMINENT LOCATION

INSTRUCTIONS TO BE FOLLOWED IN THE EVENT USER SMELLS GAS. THIS INFORMATION SHALL BE OBTAINED BY CONSULTING YOUR LOCAL GAS SUPPLIER. AS A MINIMUM, TURN OFF THE GAS AND CALL YOUR GAS COMPANY AND YOUR AUTHORIZED SERVICE AGENT. EVACUATE ALL PERSONNEL FROM THE AREA.

WARNING: IMPROPER INSTALLATION, ADJUSTMENT, ALTERATION, SERVICE OR MAINTENANCE CAN CAUSE PROPERTY DAMAGE, INJURY OR DEATH. READ THE INSTALLATION, OPERATING AND MAINTENANCE INSTRUCTIONS THOROUGHLY BEFORE INSTALLING OR SERVICING THIS EQUIPMENT.



IMPORTANT — READ FIRST — IMPORTANT

- WARNING:** THE UNIT MUST BE INSTALLED BY PERSONNEL QUALIFIED TO WORK WITH GAS, ELECTRICITY AND PLUMBING. IMPROPER INSTALLATION CAN CAUSE INJURY TO PERSONNEL AND/OR DAMAGE TO THE EQUIPMENT. THE UNIT MUST BE INSTALLED IN ACCORDANCE WITH APPLICABLE CODES.
- CAUTION:** SHIPPING STRAPS ARE UNDER TENSION AND CAN SNAP BACK WHEN CUT.
- CAUTION:** DO NOT INSTALL THE UNIT IN ANY WAY WHICH WILL BLOCK THE RIGHT SIDE VENTS, OR WITHIN 12 INCHES OF A HEAT SOURCE SUCH AS A BRAISING PAN, FRYER, CHAR BROILER OR KETTLE.
- CAUTION:** LEVEL THE UNIT FRONT TO BACK, OR PITCH IT SLIGHTLY TO THE REAR, TO AVOID DRAINAGE PROBLEMS.
- WARNING:** TO AVOID DAMAGE OR INJURY, FOLLOW THE WIRING DIAGRAM EXACTLY WHEN CONNECTING A UNIT.
- CAUTION:** DO NOT USE PLASTIC PIPE. DRAIN MUST BE RATED FOR BOILING WATER.
- WARNING:** DO NOT CONNECT THE DRAIN DIRECTLY TO A BUILDING DRAIN.
- WARNING:** BLOCKING THE DRAIN IS HAZARDOUS.
- IMPORTANT:** IMPROPER DRAIN CONNECTION WILL VOID WARRANTY.
- IMPORTANT:** DO NOT ALLOW ANY WATER TRAPS IN THE LINE. A TRAP CAN CAUSE PRESSURE TO BUILD UP INSIDE THE CAVITY DURING STEAMING, WHICH WILL MAKE THE DOOR GASKET LEAK.
- WARNING:** WHEN YOU OPEN THE DOOR, STAY AWAY FROM STEAM COMING OUT OF THE UNIT. STEAM CAN CAUSE BURNS.
- WARNING:** BEFORE CLEANING THE OUTSIDE OF THE OVEN, DISCONNECT THE ELECTRIC POWER SUPPLY. KEEP WATER AND CLEANING SOLUTIONS OUT OF CONTROLS AND ELECTRICAL COMPONENTS. NEVER HOSE OR STEAM CLEAN ANY PART OF THE UNIT.
- WARNING:** ALLOW COOKING CHAMBER TO COOL BEFORE CLEANING.
- WARNING:** CAREFULLY READ THE WARNINGS AND FOLLOW THE DIRECTIONS ON THE LABEL OF EACH CLEANING AGENT. USE SAFETY GLASSES AND RUBBER GLOVES AS RECOMMENDED BY DELIMING AGENT MANUFACTURER.
- WARNING:** DO NOT MIX DE-LIMING AGENTS (ACID) AND DE-GREASERS (ALKALI).
- WARNING:** DO NOT PUT HANDS OR TOOLS INTO THE COOKING CHAMBER UNTIL THE FAN HAS STOPPED TURNING.
- WARNING:** DO NOT OPERATE THE UNIT UNLESS THE REMOVABLE RIGHT SIDE PANEL HAS BEEN RETURNED TO ITS PROPER LOCATION.
- NOTICE:** DO NOT USE A CLEANING OR DE-LIMING AGENT THAT CONTAINS ANY SULFAMIC ACID OR ANY CHLORIDE, INCLUDING HYDROCHLORIC ACID. IF THE CHLORIDE CONTENT OF ANY PRODUCT IS UNCLEAR, CONSULT THE DISTRIBUTOR OR MANUFACTURER.
- NOTICE:** DO NOT USE ANY DE-GREASER THAT CONTAINS POTASSIUM HYDROXIDE OR SODIUM HYDROXIDE OR THAT IS ALKALINE.
- WARNING:** USE OF ANY REPLACEMENT PARTS OTHER THAN THOSE SUPPLIED BY GROEN OR THEIR AUTHORIZED DISTRIBUTOR VOIDS ALL WARRANTIES AND CAN RESULT IN BODILY INJURY TO THE OPERATOR AND DAMAGE THE EQUIPMENT. SERVICE BY OTHER THAN FACTORY-AUTHORIZED PERSONNEL WILL VOID ALL WARRANTIES.
- WARNING:** HIGH VOLTAGE EXISTS INSIDE CONTROL COMPARTMENTS. DISCONNECT FROM BRANCH BEFORE SERVICING. FAILURE TO DO SO CAN RESULT IN SERIOUS INJURY OR DEATH.

Table of Contents

IMPORTANT OPERATOR SAFETY WARNINGS	2
EQUIPMENT DESCRIPTION	4
INSPECTION AND UNPACKING	5
WATER QUALITY AND TREATMENT	6
INSTALLATION	7
INITIAL START-UP	11
OPERATING INSTRUCTIONS	13
CLEANING	19
MAINTENANCE	23
TROUBLESHOOTING	23
DIAGRAMS AND SCHEMATICS	25
REFERENCES	26
SERVICE LOG	27

OM-CC-G and C/2-G

Equipment Description

Your Groen Convection Combo™ has a stainless steel cooking chamber, an air heating compartment with heat exchange tubes and fan, a steam generator, and a control compartment which houses electrical components.

All major components of the Convection Combo™ are encased in a 16 gauge stainless steel cabinet. The cabinet is lined with 1½ to 2 inches (4 to 5 cm) thick glass fiber insulation. A removable drip tray is located beneath the door.

The door is reversible so that it may open from the left or right. Operator controls are located on the right front of the unit, except for the pilot control switch and manual gas shut-off valve, which are behind the sliding access door on the right side of the unit.

Standard controls let you to operate the Convection Combo in any one of three cooking modes:

1. As a convection oven
2. As a self-contained pressureless steamer
3. As a combination oven-steamer

Models CC10-G and C/2-20G differ in cooking chamber size and pan capacity:

CC10-G: 4 steam table pans (12x20x2½"), or 7 half-size (13x18") US bake pans

C/2-20G: 10 steam table pans (12x20x2½"), or 9 full-size (18x26") US bake pans

Units are supplied on a stainless steel stand. The smaller Convection Combo™ is available as the single CC10-GF or the double stacked (2) CC10-GF. The larger unit is available as the single C/2-20GF or the double-stacked (2)C/2-20GF.

Controls and monitoring displays for cooking times, operating mode and temperature selection are on the control panel. The upper portion of the panel has a digital cooking time readout and touch pads for setting cook times. Below the timer section are lights which indicate the status of the unit and touch pads to select the mode of operation and to switch on power.

A digital readout shows the selected temperature, which is entered by turning a dial. Pilot burner status is shown by a light on the pilot ignition switch.

An insulated, gas-fired steam generator is mounted behind the oven. Steam enters the oven through a connecting tube near the bottom left rear corner of the oven.

The deliming port is located on the stand just below the control panel. De-liming solution goes through

this port into a fill tank, from which it is transferred to the steam generator during the unique Groen automatic cleaning cycle.

The air heating space which contains the heat exchanger tubes is also separated from the cooking chamber by removable left, right, top and bottom partitions. The compartment which contains the unit's automatic controls and other electrical components is on the right side of the unit, and is accessed by removing the right *outside* panel.

A drain is located in the removable bottom of the cooking chamber. Fluids drain from this removable bottom and from the permanent floor to the stainless steel drain pipe outside the oven. The drain pipe includes a spray condenser which suppresses any steam escaping from the chamber and a drain box.

BURNER FIRING RATES

Input Rates, BTU/hour

CC10-G or per chamber for (2)CC10-G		
Mode	Natural Gas at 3.7" W.C.*	L.P. Gas at 10.5" W.C.*
Oven	45,000	45,000
Steam	48,000	48,000
Combo	54,600	54,600
Preheat (Max)	93,000	93,000
C/2-20G or per chamber for (2)C/2-20G		
Mode	Natural Gas at 4.5" W.C.*	L.P. Gas at 10.0" W.C.*
Oven	90,000	90,000
Steam	100,000	100,000
Combo	100,000	100,000
Preheat (Max)	186,000	186,000

*Manifold Pressure

Inspection and Unpacking

Your Convection Combo™ will be completely assembled in a heavy shipping carton (CC10-G) or wooden crate (C/2-20G), and attached to a skid. On receipt, inspect the carton or crate carefully for exterior damage.

CAUTION
SHIPPING STRAPS ARE UNDER TENSION AND CAN SNAP BACK WHEN CUT.

Carefully cut the straps around the carton and detach the sides of the carton from the skid. Pull the carton up off the unit. Be careful to avoid personal injury or equipment damage from nails and sharp pieces of wood or staples which might be left in carton walls.

Write down the model number, serial number and installation date and keep this information for future reference. Space for these entries is provided at the top of the Service Log in the back of this manual.

CAUTION
THIS UNIT IS VERY HEAVY. YOU SHOULD GET HELP AS NEEDED AND USE MATERIAL HANDLING EQUIPMENT TO REMOVE THE UNIT FROM THE SKID AND MOVE IT TO ITS PLACE OF INSTALLATION.

When starting installation, use material handling equipment to lift the unit straight up off the skid. Check packing materials to make sure loose parts are not discarded with the material.



The unit will be delivered in either a heavy carton (CC10-G and C/2-20GF) or a heavy wooden crate ((2)CC10-G and (2) C/2-20GF), strapped to a wooden skid. (CC10-GF pictured)

Water Quality and Treatment

It is essential to supply the steam generator/boiler with water that will not form scale. Even though the steam generator/boiler is engineered to minimize scale formation, scale development depends on the hardness of your water and the number of hours you operate the equipment each day.

Most water supplies contain minerals which form scale. It is this scale which could lead to an early component failure.

Your local water utility can tell you about the minerals in your water. The water going to the steam generator should have between 30 and 40 parts per million (ppm) total dissolved solids (TDS) and should have a pH (acidity rating) of 7.0 to 9.0. Please follow these simple precautions:

1. The best way to prevent scale is to use a Groen PureSteam™ Water Treatment System which has been specifically designed for Groen steamers and combination ovens. **Do not rely on unproven water treatments** sold for scale prevention and removal. **They are not specifically designed to work with Groen steamers and combination ovens.**
2. A well-maintained water treatment system and a regular cartridge replacement schedule is essential.

3. Using a Groen water treatment system will provide longer steam generator/boiler life, higher steam capacity, and reduce maintenance requirements.
4. If you notice a slowdown in steam production or an increase in deliming, have the Combo checked for scale build-up. This could be an indication that the water treatment cartridges need replacing. Heavy scale reduces the unit's ability to boil water, and can even cause component failure.

MINIMIZE SCALE PROBLEMS BY INSTALLING AND MAINTAINING A GROEN WATER TREATMENT SYSTEM AND BY DELIMING THE STEAM GENERATOR/BOILER REGULARLY.

Groen Convection Combo™ ovens feature two separate water inlets — one for the steam generator/boiler (for treated water), the other for the spray condenser (untreated water). The second intake will reduce water treatment requirements resulting in significant savings.

The dual water connections are on the rear of the unit.



Standard water connections for steam generator and drain spray condenser.

Installation and Start-Up

WARNING

THE UNIT MUST BE INSTALLED BY PERSONNEL WHO ARE QUALIFIED TO WORK WITH GAS, ELECTRICITY AND PLUMBING. IMPROPER INSTALLATION CAN CAUSE INJURY TO PERSONNEL AND/OR DAMAGE TO THE EQUIPMENT. THE UNIT MUST BE INSTALLED IN ACCORDANCE WITH APPLICABLE CODES.

CAUTION

DO NOT INSTALL THE UNIT WITH THE RIGHT SIDE VENTS BLOCKED OR WITHIN 12 INCHES OF A HEAT SOURCE (SUCH AS A BRAISING PAN, DEEP FRYER, CHAR BROILER OR KETTLE).

DO NOT INSTALL TO THE LEFT OF ANY OPEN-FLAME EQUIPMENT. DO NOT INSTALL UNIT WITHIN FOUR FEET OF A STEAM DRAIN.

TO AVOID DRAINAGE PROBLEMS, LEVEL THE UNIT FRONT TO BACK.

INSTALLATION MUST BE IN ACCORDANCE WITH ALL APPLICABLE CODES.

Installation

1. Mounting

Minimum rear clearance is 6" from back of oven.

If you wish to install a Convection Combo™ on top of another, you should obtain a double stacked unit from the factory.

The unit must be installed in an adequately vented room with a provision for an ample air supply to the unit. The unit must be installed completely under a ventilation hood, since flue products exit the appliance over its entire depth. Anything which might restrict the flow of air for ventilation and combustion must be removed. Do not obstruct the flue cover or any front, side, top or rear vents after installation. The area directly around the Convection Combo™ must be cleared of all combustible material.

Installation must comply with local codes, or in the absence of local codes, conform to the National Fuel Gas Code ANSI Z223.1 - latest edition, including:

“The appliance and its individual shut-off valve must be **disconnected** from the gas supply piping system during any pressure testing of that system at test pressures **in excess of** ½ psig (3.45 kPa). The appliance must be **isolated** from the gas supply by closing its individual manual shut-off valve during any pressure testing of the gas supply piping system at test pressures **equal to or less than** ½ PSI (3.45 kPa).”

2. Gas Supply Connections

WARNING

THIS UNIT IS FOR COMMERCIAL USE. NEVER USE HOME OR RESIDENTIAL GRADE GAS CONNECTIONS. THEY DO NOT MEET GAS CODES AND COULD BE HAZARDOUS.

Connect to the gas supply using ½ NPT pipe for the CC10-E and ¾ NPT pipe for the C/2-20E or an approved equivalent. Although the immediate connection to the Convection Combo™ is either ½ or ¾ NPT, the gas supply piping must be large enough to provide 93,000 BTU/hour for each CC10-G cooking chamber or 186,000 BTU/hour for each C/2-20G cooking chamber. Supply pressure must be at least 5" W.C. (maximum 14" W.C.) for natural gas or 12" W.C. (maximum 14" W.C.) for LP gas. **In Canada**, the installation must conform to the Canadian Gas Code, CAN 1-B149, Installation Codes for Gas Burning Appliances and Equipment, and/or local codes.

For units on casters, complete the gas supply connection using only connectors that meet the standards for movable gas appliances, ANSI Z21.69 — latest edition. Restrain movement of the unit by attaching a cable or chain to the eyelet (provided at the back of the frame) and anchoring the cable or chain to the wall or floor. Make the length and location of the cable such that the unit cannot pull on the gas connection while the cable is connected.

OM-CC-G and C/2-G

3. Electrical Supply Connection

For a single oven, or for each oven in a double stacked unit, provide 115 VAC, 60 Hz, single phase, 15 AMP service. Local codes and/or the National Electrical Code should be observed in accordance with ANSI/NFPA 70-1987 (or latest edition). **AN ELECTRICAL GROUND IS REQUIRED.** The electrical schematic is located in the service compartment and this manual. Maximum load per oven is 5½ AMPs. In **Canada** provide electrical service in accordance with the Canadian Electrical Code, CSA C22.1 Part 1, and/or local codes.

4. Water Supply Connection

A check valve (anti-siphonage device) must be installed in the incoming **cold** water lines in keeping with local plumbing codes. Water line pressure should be between 30 and 60 PSI (210 and 410 kPa). A pressure regulator is required above 60 PSI (410 kPa).

A ¾ inch (19 mm) NH connector is required to connect each water supply to the water inlet valve. The water feed line diameter may not be less than ½ inch (13 mm). Use a washer (or if necessary, two washers) in the hose connection. Do not allow the connections to have any leaks, no matter how small.

Minimum flow rate for water delivery is 1.5 gallons per minute. Below this rate your Combo oven will not operate. Condensate spray rate at 30 PSI is 0.34 gallons per minute for CC10-G units, and 0.7 gallons per minute for the C/2-20G. Double stacked units require double the rates. To convert a steamer or combination oven to a single water connection, order single cold water adapter (part # 138473).

5. Drain Connection

a. Unit Without Drain Tank (See figures on page 10)

A 1½ inch (4 cm) ID (CC10-G) or 2 inch (5 cm) ID hose (C/2-20G) may be attached to the supplied drain outlet with a clamp. Do **not** use plastic pipe, because the drain must withstand very hot water.

WARNING:
DO NOT CONNECT THE OVEN DRAIN DIRECTLY TO A BUILDING DRAIN.

There must be a free air gap between the end of the hose and the building drain. The free air gap should be as close as possible to the unit's drain. There must also be no

other elbows or other restrictions between the unit drain and the free air gap.

CAUTION
DO NOT USE PLASTIC PIPE. DRAIN MUST BE RATED FOR VERY HOT WATER.

WARNING
BLOCKING THE DRAIN IS HAZARDOUS.

On a double stacked unit, there must be a minimum of two inches free air gap on **each** drain, as close to each oven as possible. Double stacked units may only share a common drain hose downstream of **both** free air gaps.

Install the drain line with a constant downward pitch. This is especially important for double-stack units. The bottom unit is conceptually shown below.

IMPORTANT: Do not allow any water traps in the line. A trap can cause pressure to build up inside the cavity during steaming, which will make the door gasket leak.

NOTE: Improper drain connection will void the warranty.

b. Units With Drain Tank (See figures on page 10)

A hose may be attached to the supplied drain elbow with a clamp. Use 1½ inch ID hose for CC10-G or 2" ID hose for C/2-20G. The hose may be connected directly to a building drain since the drain tank has an air vent, which eliminates the need for a free air gap at the building drain.

Do not block the air vent in any way. Do not attach anything to the vent tube or reduce its size.

Do **NOT** use plastic pipe in the drain line, because the drain must withstand very hot water.

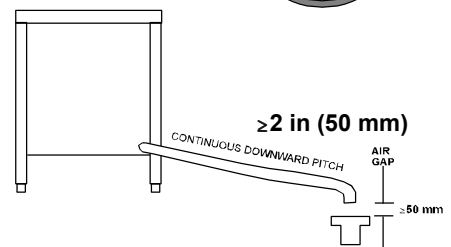
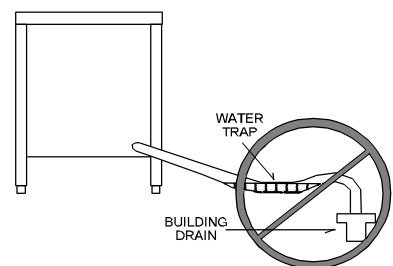

Convection Combo™ Utility Connections

NOTE: Remove right side panel to make connections at terminal block in rear of control compartment.

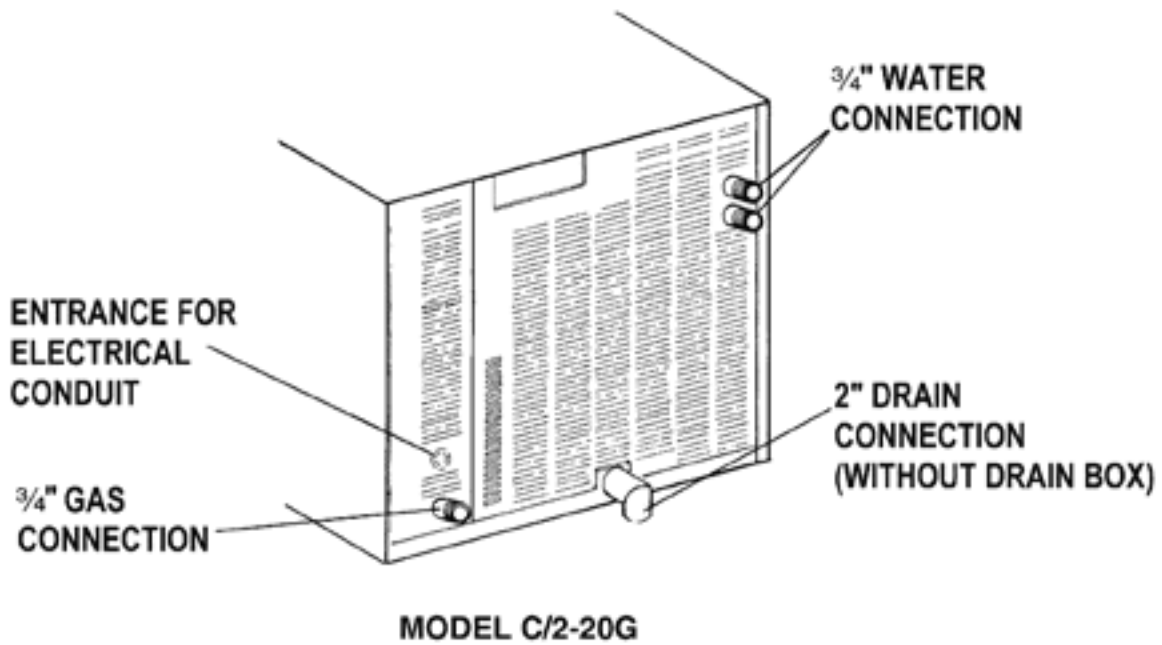
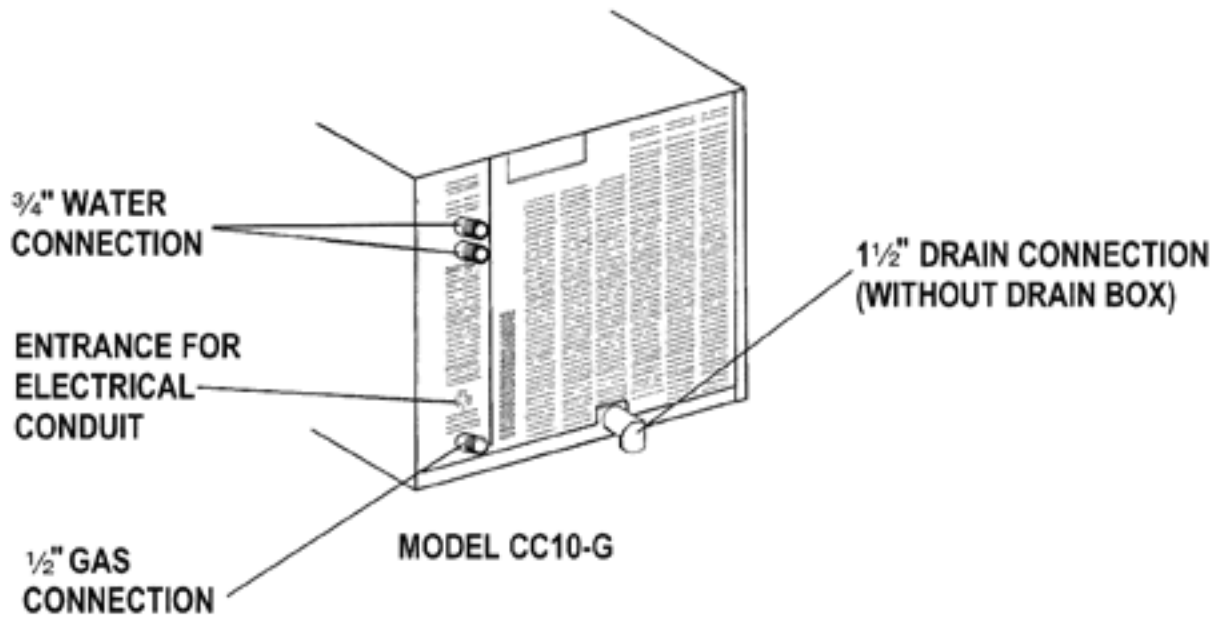

Proper Drain Line Connections

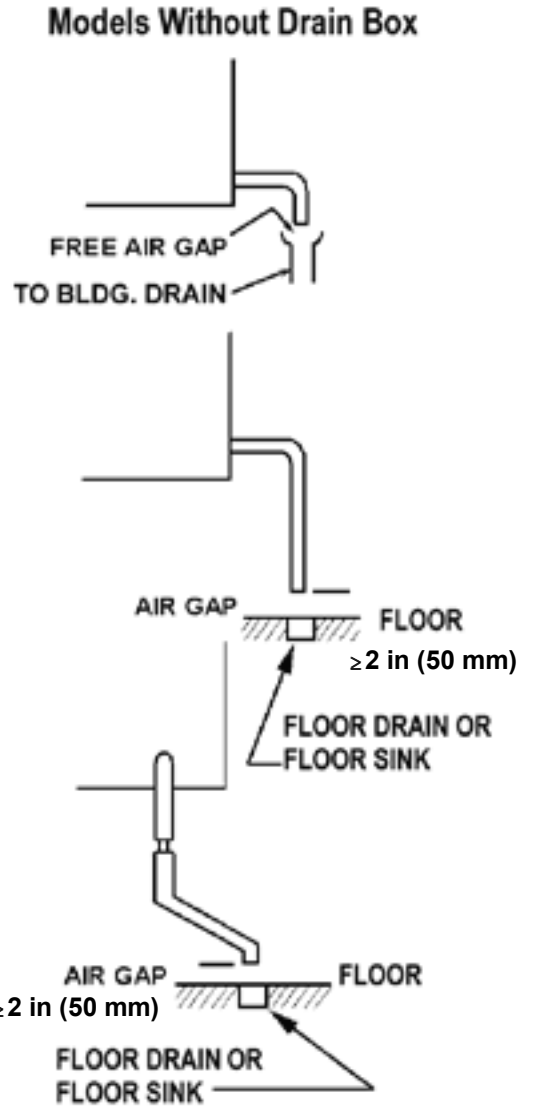
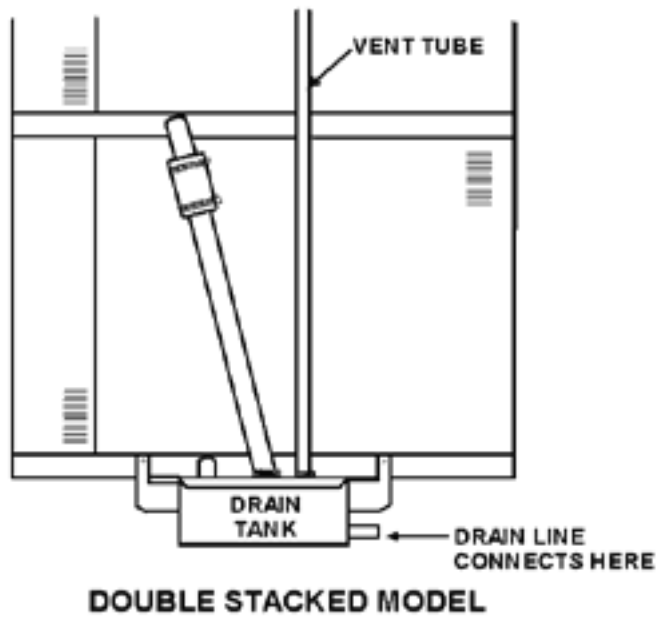
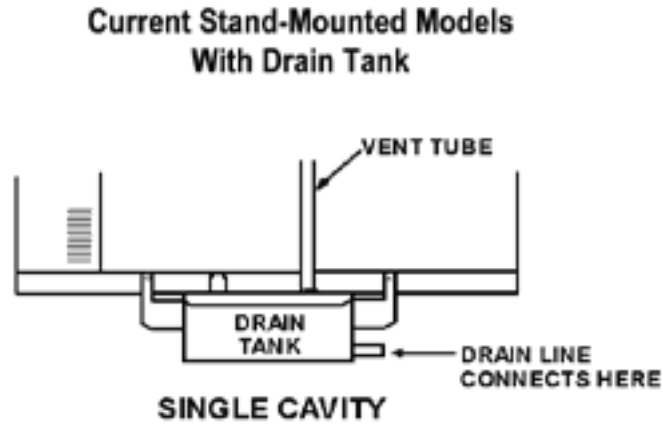

Initial Start-Up

WARNING
ANY POTENTIAL USER OF THE EQUIPMENT SHOULD BE TRAINED IN SAFE AND CORRECT OPERATING PROCEDURES.

After the Convection Combo™ has been installed, test it to ensure that it is operating correctly.

1. Remove all literature and packing materials from the interior and exterior of the unit.
2. Check that the cold water supply line is open and that the fittings are not leaking.
3. Make sure that the gas supply line is open. On newer units, turn the knob of the main gas valve so that it is lined up with the pipe.

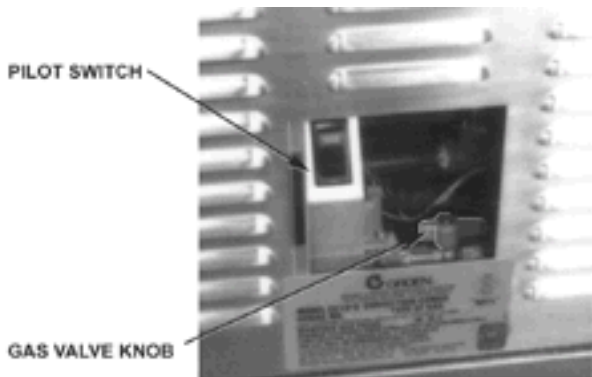

These controls are behind the sliding door on the right side panel, facing the unit.

4. Turn on electrical service to the unit. **Because the unit will not operate without electrical power, no attempt should be made to operate the unit in the event of a power failure.**
5. The control panel will not operate until the pilot burner has been ignited. To light the pilot burner, activate the pilot switch located next to the main gas valve. Once the pilot ignition sequence has been successfully completed, a green light will glow, and power will be supplied to the front panel.
6. The “trial for ignition” period is roughly 70 to 90 seconds. If the pilot burner does not light within 90 seconds of pilot switch activation, the ignition system automatically stops the gas flow to the pilot burner and cancels the ignition trial. If the ignition trial is terminated, turn off the pilot switch and repeat the trial for ignition. During initial start-up, the pilot may require several trials in order to bleed air from the gas piping. Subsequent start-up should only require about five seconds to achieve ignition.

NOTE: See Automatic Operation of Pilot at the end of this section.

7. Once the pilot burner flame has been established (the green light at the pilot switch is on), all operator commands are executed via the front control panel touch pads. See the Operation section for details.
8. **High Altitude Operation.** At altitudes above 5,000 feet (1524m), the unit will not operate in the Steamer or Combo Modes unless the altitude is set. The Convection Combo™ is delivered with the altitude set for 1000 feet as default. You can program the altitude as follows:
 - a. If the unit is on, turn it off by pressing the **ON** touch pad.
 - b. Press and hold the **STEAM** touch pad while turning the unit on by pressing the **ON** touch pad. The Time/Status display will show the letters AL and a number representing the altitude in thousands of feet. If the altitude has not been set for your unit, the display will be 0.
 - c. Enter an altitude value between 0 and 15, using the numbered touch pads. For example, if the unit will be operating at 7,000 feet, enter 7.
 - d. Press the **START** touch pad to accept the change.

Altitude Metric Conversion

Altitude		Setting
Feet	Meters	
1000	305	1
2000	610	2
3000	914	3
4000	1219	4
5000	1524	5
6000	1830	6
7000	2133	7
8000	2438	8
9000	2745	9
10000	3048	10
11000	3353	11
12000	3658	12
13000	3962	13
14000	4267	14
15000	4572	15

OM-CC-G and C/2-G

- 9. Select Fahrenheit or Celsius Temperatures.**
The Convection Combo™ is delivered with the Fahrenheit scale as default. To change the temperature scale, hold the 5 key in, and press ON. The Time/Status display will show dEG°F or dEG°C. Press the 5 key to change from one to the other. Press START to accept the change.
- 10. To Test Steamer Mode Operation,** turn on the unit. (For operating procedure details, see the Operation section of this manual.) Clear time from the time display. Close the door and press the **STEAM** touch pad. (If the **HOT** light is on, see Fast Cool in the Operation section.)

The **WAIT** light will stay on while the steam generator fills with and heats the water. It should turn off within three minutes, and the **READY** light should come on. This indicates that the water is at its standby temperature. The timer only controls operations in the Steamer Mode. Enter a time and press **START**. (“Time” is set in minutes and hours only. Seconds are not displayed).

Examples: 2 minutes = 00:02

(Just press 2).
1 hour and 30 minutes = 01:30
(Press 1, 3, and 0, or press 9 and 0
the timer will change to 1:30)

The colon [:] between the numbers will blink and the generator will begin to produce steam. Time only counts down when the **READY** light is lit.

NOTE: You cannot change modes if the timer is running.



WARNING
WHEN YOU OPEN THE DOOR, STAY AWAY
FROM STEAM COMING OUT OF THE UNIT.
THE STEAM CAN CAUSE BURNS.

- 11. Test Combo Mode Operation,** turn on the power and clear any time from the Time/Status display. Press the **COMBO** touch pad. Set the **COOK** temperature to 350°F (175°C). The **WAIT** light will come on. It will remain on while (1) the steam generator fills with water and heats it to its standby temperature and (2) the air heater raises the air temperature to 350°F. Both actions should be completed in five to eight minutes, starting with a cold unit. When the set temperature is attained, the **WAIT** light will go off, and the **READY** light will come on. **NOTE:** The timer does not control the oven in either the Combo or Oven Modes.
- 12. Test Oven Mode Operation,** turn on the power and clear the Time/Status display. Press the **OVEN** touch pad. Set the cook temperature to 350°F (175°C). The **WAIT** light will come on. Within eight minutes of a cold start, the **WAIT** light should go out and the **READY** light come on. When that happens, turn the **COOK** setting down to 320°F (160°C). The **HOT** light will come on. Heat-up times may vary slightly with voltage or water pressure differences.
- 13.** To shut down the unit, switch off the power. The pilot burner may also be turned off to conserve energy.
- 14.** If the Convection Combo™ works as described, the unit is functioning correctly and is ready for use.

Operation

WARNING

ANY POTENTIAL USER OF THE EQUIPMENT SHOULD BE TRAINED IN SAFE AND CORRECT OPERATING PROCEDURES.

DO NOT OPERATE THE UNIT AT ALL, UNLESS ALL FOUR REMOVABLE COOKING COMPARTMENT PARTITIONS HAVE BEEN RETURNED TO THEIR PROPER LOCATION.

DO NOT OPERATE THIS EQUIPMENT WITHOUT ELECTRIC POWER.

NOTE: Before the control panel can be used, the pilot burner flame must be on. See “Initial Start-Up.”

A. Controls and Indicators

Operator controls are on the right front side of the unit. Their use is described below:

1. Time Section

In Oven and Combo Modes, the timer functions only as a “cooking time minute minder” and does not turn the unit on or off. In the Steamer Mode, however, it controls the steaming function.

- a. **Time/Status Display** — Shows operating time remaining in the Steamer, Oven or Combo Mode. The timer counts **down**. If the unit is equipped with, and operating in the optional Hold Mode, the timer will count **up** alternating with the word “Hold,” and will show the total accumulated time that the product has been holding. The display shows operating time in “hours:minutes” format. For example, entering 9 and 0 will result in a display of 01:30.
- b. **Number touch pads** — used to enter time values.
- c. **CLEAR** — Pressing this touch pad once stops the beeper and resets the timer to the time that was last set. Pressing twice clears it to 00:00. At the end of a cooking period, opening the door is the same as pressing **CLEAR** once.
- d. **START** — Press this touch pad to start the timer. If the unit is in Steamer Mode, it will also cause steaming to begin.

2. Status Lights

- a. **HOT** — Indicates chamber temperature is more than 15°F (8°C) over the set temperature. (See Paragraph 5 in this section)

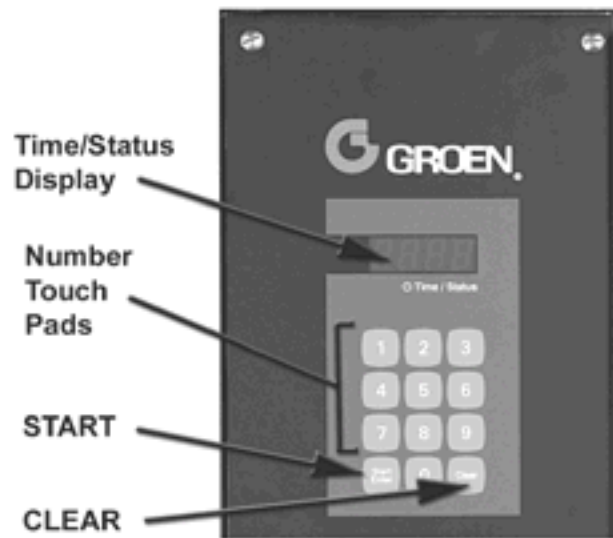

- b. **SERVICE** — Indicates that there is a problem which **might** require a service call. If there is such a problem, the beeper will sound and the **SERVICE** light will be on when you switch on the power. The unit may continue to operate, depending on the type of problem. Refer to the Troubleshooting section to determine the nature and severity of the problem.
- c. **WAIT** — Indicates the unit is either heating or cooling toward the set temperature. The **HOT** and **WAIT** lights will both be on if the chamber is more than 15°F (8°C) above the set point.
- d. **READY** — Indicates the unit is ready for use.
- e. **CLEAN** - Indicates the unit needs cleaning. The unit will temporarily function if this light is flashing.

3. Cooking Mode Selection

These touch pads are used to select the mode of operation. If a mode is off, pressing the pad for that mode will turn it on. If the mode is on, pressing its pad will turn it off. A light just above each pad indicates which has been selected.

Standard Operating Controls

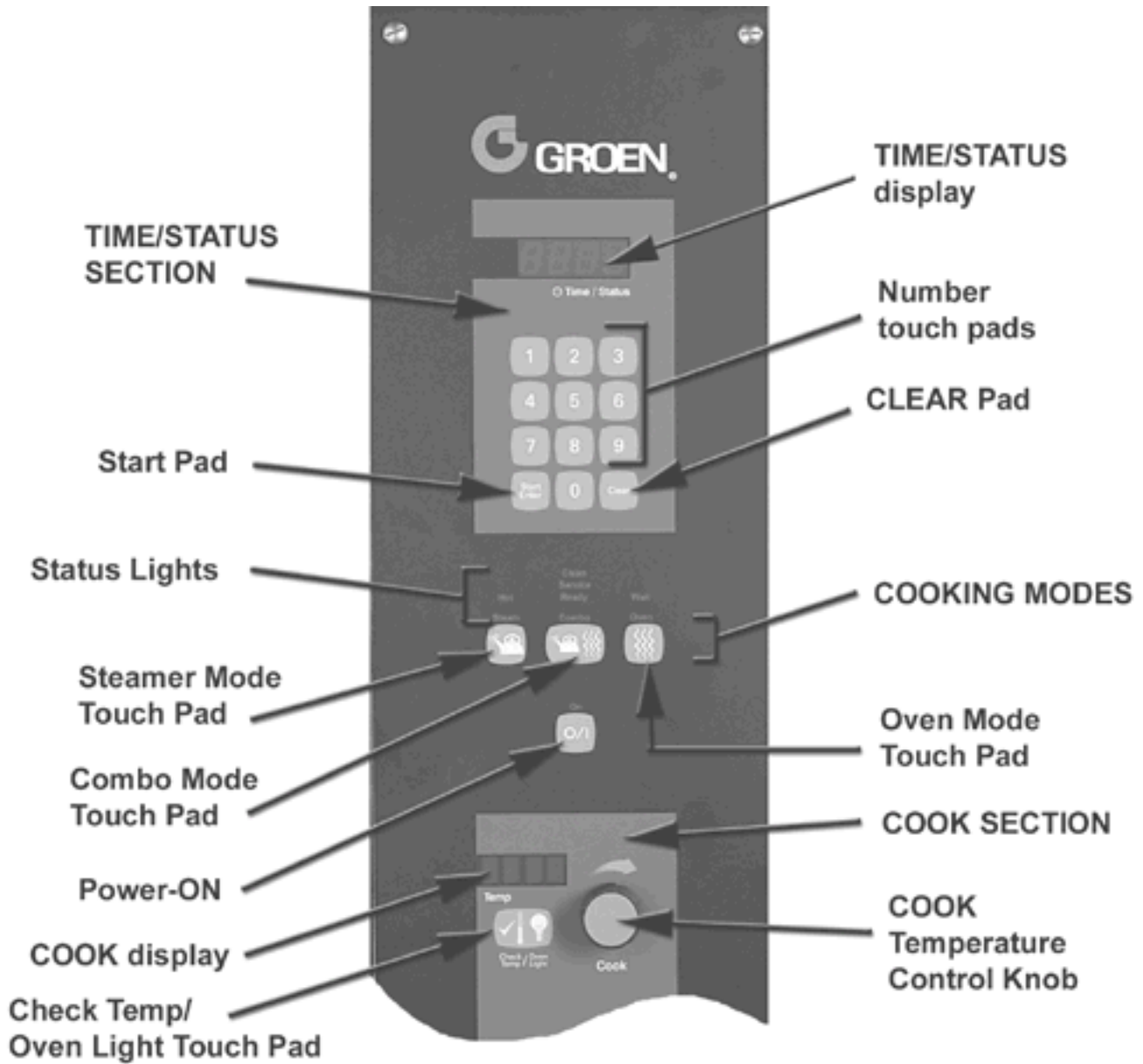

- a. **STEAM** — Selects steamer operation only.
- b. **COMBO** — Selects superheated steam and convection oven operation.
- c. **OVEN** — Selects convection oven operation only.

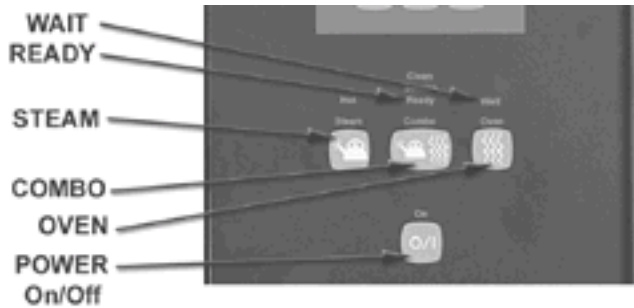

4. **Power**

The **ON** touch pad turns the unit on or off. When power is on, the **ON** light just above the touch pad is lit. Use of this pad does not reset the controls. The unit will always come on in the same mode it was in when shut down.

5. **Temperature (TEMP) Section**

- a. The Cook display shows the selected temperature in either Oven or Combo Mode. It is blank in the Steamer Mode.
- b. Turning the Temperature Control Knob selects the cooking temperatures in 5°F increments. The control ranges are:

Oven Mode	200-575°F (95-300°C)
Combo Mode	220-575°F (105-300°C)

NOTE: Maximum temperature is limited to 500°F when either the optional probe or optional hold mode is in use.

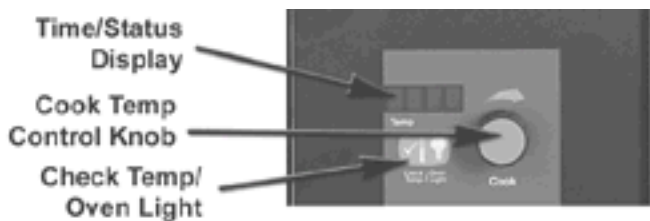

6. **Optional Features**

If the following features are included, please refer to the control panel guide which was provided with the unit:

- Cook Only Guide: P/N 121084
- Programmable: P/N 121042
- Probe & Hold: P/N 121072

B. **Operating Instructions**

1. **Steam Mode**

- a. If the unit is off, switch on the electric power by pressing the **ON** touch pad. (If the **SERVICE** light comes on when you turn on the power, see the Troubleshooting section).
- b. If the power is already on, and there is a number in the time display window, press the **CLEAR** touch pad one or more times to reset the time to zero.

NOTE: You cannot change operating modes while the timer is running

- c. The unit will be in the mode of operation in which it was last used. Because of this, the indicator light for that mode will be lit. If the unit is not already in the Steamer Mode, press the **STEAM** touch pad. The **STEAM** light will come on and the Cook display will go blank.
- d. If the unit was recently used in Oven or Combo Mode, the **HOT** light may come on, indicating that the cooking chamber is too hot for use as a steamer. The unit can be cooled quickly to the steaming temperature range by leaving the door open or following the Fast Cool procedure described near the end of this section (Paragraph 4). With the door open, the generator can fill and heat the water to 200°F (93°C), but it cannot produce steam.



WARNING
WHEN YOU OPEN THE DOOR STAY AWAY FROM ANY STEAM COMING OUT OF THE UNIT. STEAM CAN CAUSE BURNS.

- e. The **WAIT** light will be on until the water reaches 200°F (93°C). It will then turn off and the **READY** light will come on. You are now ready to steam foods in your Convection Combo™.
- f. Load the food into pans in an even, uniform layer.
- g. Carefully open the door and slide the pan or pans onto the pan racks in the cooking chamber. If you are only using one pan, place it in the middle position. Close the door.

OM-CC-G and C/2-G

- h. Press the numbered touch pads to set the cooking time. The time will appear in the Time/Status display. If you enter the wrong number, press the **CLEAR** touch pad to erase the time from the display, and enter the time again.
- i. When the correct cooking time has been entered, press the **START** pad. The colon in the Time/Status display will blink and the time will count down the cooking time. (The unit must be **READY** before the timer can count down.)
- j. If you open the door during the cooking period, steaming and the timer will stop (but will not reset). When you close the door, steaming and timing will resume.



WARNING
WHEN YOU OPEN THE DOOR STAY AWAY FROM ANY STEAM COMING OUT OF THE UNIT. STEAM CAN CAUSE BURNS.

- k. When the timer reaches zero, it stops steam generation and sounds a beeper. Water in the steam generator stays at its standby temperature (200°F - 93°C). On older models, the beeper will sound until the door is opened or **CLEAR** is pressed.
- l. Carefully open the door. If the food is cooked, remove the pans using hot pads or oven mitts to protect your hands.
- m. After the display has counted down to zero, opening the door or pressing **CLEAR once** will reset the display to the time that was last used. Pressing **START** will repeat the cook cycle. If the same cooking time will be used, you only need to press the number keys when you first set that time.
- n. After the Time/Status display has counted down to zero, you can reset the time to zero by either (1) opening the door **and** pressing **CLEAR** or pressing **CLEAR** twice. A new cooking time may then be set by using the number keys.

2. Oven Mode

- a. To use the Convection Combo™ as a convection oven, switch on the electric power by pushing the **ON** touch pad. (If the **SERVICE** light comes on when you turn on the power, see the Troubleshooting section).

If the door is closed and the cooking temperature is above 250°F (120°C) the fan will begin to operate.

- b. If the power is already on, and there is a number in the Time/Status display, press **CLEAR** one or more times to reset the time to zero.
- NOTE:** You cannot change operating modes while the timer is running
- c. The unit will power up in the mode in which it was last used. Because of this, the indicator light for that mode will be lit. If the unit is not already in the Oven Mode, press the **OVEN** touch pad. The **OVEN** light will come on and the oven fan will operate.

- d. Use the Temperature Control Knob to set the desired cooking temperature between 200° and 575° F (93° to 300° C). **NOTE:** Maximum temperature is limited to 500°F when either the optional probe or optional hold mode is in use. The temperature will appear in the Cook display. Unless the cooking chamber is already at or above the selected temperature, the unit will start heating and the **WAIT** light will come on.
- e. If the unit was recently used at a temperature 15°F (8°C) or more over the selected temperature, the **HOT** and **WAIT** lights will come on. The unit can be cooled quickly to the desired cooking temperature by leaving the door open or following the Fast Cool procedure described near the end of this section (Paragraph 4).
- f. The **READY** light will indicate when the oven is at the desired temperature.
- g. Load the food into the pan or pans in a uniform layer.
- h. The Convection Combo™ will operate in Oven Mode with the timer either on or off. If you want to time cooking, press the numbered pads in the Time/Status portion of the control panel to set the cooking time. The time will appear in the Time/Status display. If you enter the wrong number, press **CLEAR** to erase the time from the display, and reenter the time. Remember that the timer **does not control** the unit in the Oven Mode.



- i. Open the door and slide the pan or pans onto the pan racks in the cooking chamber. If you are only using one pan, place it in the middle position. Close the door.
- j. If the correct time has been set on the timer, press the **START** pad. The colon [:] between the numbers in the Time/Status display will blink and the time will count down the cooking time. When the timer has counted down to zero, it will sound a beeper. This sound will continue until the door is opened or the **CLEAR** pad is pressed.
- k. To stop cooking, take the pans out of the oven using hot pads or oven mitts to protect your hands from the hot pans. The unit will continue heating to keep the chamber at the set temperature until the temperature control is reset, or the power is shut off.



WARNING
PANS AND INTERNAL PARTS OF THE OVEN WILL BE VERY HOT. AVOID CONTACT WITH HOT SURFACES.

- l. Opening the door during operation shuts off power to the heaters and fan and stops the timer, but it has no other effect on the controls. When the door is closed, operation continues. Note that cooking time will be extended by the period the door was open.

3. Combo Mode

- a. If the unit is off, switch on the electric power by pressing the **ON** touch pad. (If the **SERVICE** light comes on when you turn on the power, see the Troubleshooting section). If the door is closed and the cooking temperature is above 200°F (93°C) the fan will begin to operate.
- b. If the power is already on, and there is a number in the time display window, press the **CLEAR** touch pad one or more times to reset the time to zero.

NOTE: You cannot change operating modes while the timer is running

- c. The unit will power up in the mode of operation in which it was last used. Because of this, the indicator light for that mode will be lit. If the unit is not already in the Combo Mode, press the **COMBO** touch pad. The **COMBO** light will come on and if the steam generator is not already full, water will flow into it and begin heating.
- d. Use the Temperature Control Knob to set the desired oven temperature between 220 and 575°F (105 to 300°C). The temperature will appear in the Cook display.
- e. If the unit was recently used at a temperature more than 15°F (-8°C) higher than the temperature selected, the **HOT** and **WAIT** lights will turn on. The unit can be cooled quickly by leaving the door open or following the Fast Cool procedure described near the end of this section (Paragraph 4).



WARNING
WHEN YOU OPEN THE DOOR STAY AWAY FROM ANY STEAM COMING OUT OF THE UNIT. STEAM CAN CAUSE BURNS.

- f. The **WAIT** light will be on until the water in the steam generator reaches boiling and the air in the cooking chamber reaches the set temperature. It will then turn off and the **READY** light will come on to indicate that the oven is at the desired temperature.
- g. The unit will operate in Combo Mode with the timer either on or off. If you want to time the cooking, press the numbered pads in the Time/Status portion of the control panel to set the cooking time. The time will appear in the Time/Status display. If you enter the wrong number, press the **CLEAR** touch pad to erase the time from the display, and enter the time again. The timer **does not control** the unit in Combo Mode.
- h. Load the food into the pan or pans in a uniform layer.

OM-CC-G and C/2-G



WARNING
WHEN YOU OPEN THE DOOR STAY AWAY FROM ANY STEAM COMING OUT OF THE UNIT. STEAM CAN CAUSE BURNS.

- i. Open the door and slide the pan or pans onto the pan racks in the cooking chamber. If you are only using one pan, place it in the middle position. Close the door.
- j. If the timer has been set, press the **START** pad. The colon [:] between the numbers in the Time/Status display will blink and the time will count down the cooking time. When the timer has counted down to zero, it will sound a beeper. This beeping will continue until the door is opened or the **CLEAR** pad is pressed.
- k. To stop cooking, take the pans out of the oven using hot pads or oven mitts to protect your hands from the hot pans. The unit will continue steaming and heating the oven at the set temperature until the temperature control is reset or the power is shut off.

4. Fast Cool

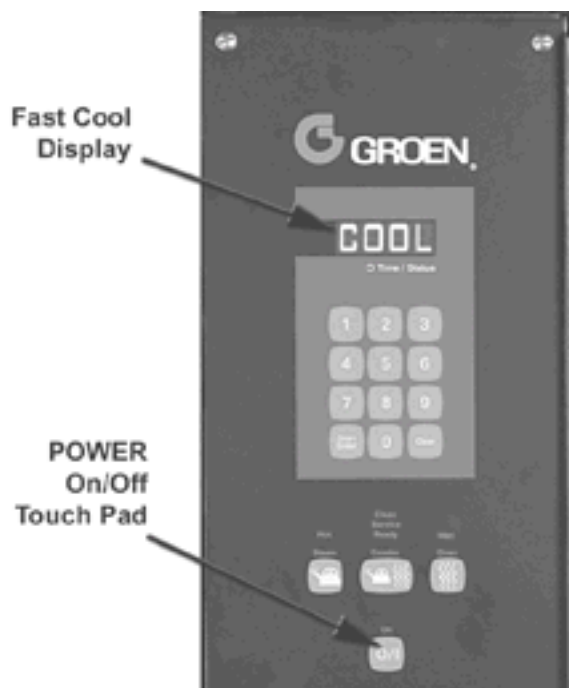

- a. When the **HOT** indicator is lit and the timer is cleared, the unit can be cooled quickly by opening the door and pressing **START**. The fan will operate, and the Time/Status display will show the word "**COOL.**" This is the only time the fan operates **with the door open.**

WARNING
DO NOT PUT HANDS OR OTHER OBJECTS INTO THE COOKING CHAMBER DURING THE FAST COOL OPERATION. THE ROTATING FAN CAN BE HAZARDOUS.

- b. To stop the Fast Cool operation, press any touch pad or close the door.

5. Shutting Down

- a. Press the touch pad for the mode in which the unit is operating.
- b. Switch off the power by pressing the **ON** touch pad.

Leave the door at least partially open, if local sanitation regulations permit.

Cleaning

To keep your Convection Combo™ in proper operating condition and to make the cleaning process easier, cleaning should be a daily activity.

A. Suggested Tools and Cleaners

1. Mild detergent
2. Stainless steel exterior cleaner such as Zepper®
3. Steam generator de-liming agent, such as **Groen Delimer Descaler**, (P/N 114800) or an equivalent. A liquid de-liming agent will be easier to use than crystals or powders. **See the warning about chlorides below.**
4. De-greaser, such as, **Groen Degreaser**.
5. Cloth or sponge
6. Plastic wool or a brush with soft bristles
7. Spray bottle
8. Measuring cup
9. Nylon pad
10. Towels
11. Plastic disposable gloves



B. PROCEDURE

1. Exterior Cleaning

- a. Prepare a warm solution of the mild detergent as instructed by the supplier. Wet a cloth with this solution and wring it out. Use the moist cloth to clean the outside of the unit. Do not allow freely running liquid to touch the controls, the control panel, any electrical part or any open louver.
- b. To remove material which may be stuck to the unit, use plastic wool, a fiber brush, or a plastic or rubber scraper with a detergent solution.
- c. Stainless steel surfaces may be polished with a recognized stainless steel cleaner such as Zepper®.
- d. For glass surfaces, use a mild detergent without abrasives or a high quality glass/surface cleaner with a clean cloth or sponge. Do not spray hot glass with water or chemicals. This could cause the glass to break from thermal shock.
- e. Use a mild soap without abrasives and warm water to clean the door gasket. **DO NOT** use caustic oven cleaners on the door gasket, as this will damage it.



PRECAUTIONS

WARNING

DISCONNECT THE POWER SUPPLY BEFORE CLEANING THE OUTSIDE OF THE UNIT.

KEEP WATER AND CLEANING SOLUTIONS OUT OF CONTROLS AND ELECTRICAL COMPONENTS. NEVER HOSE OR STEAM CLEAN ANY PART OF THE UNIT.

BE CAREFUL CLEANING THE TOP FLUE COVER AND THE OVEN TOP. BOTH AREAS MAY BE VERY HOT.

DON'T MIX DE-LIMING AGENTS (ACID) WITH DE-GREASERS (ALKALI) ANYWHERE IN THE UNIT

AVOID CONTACT WITH ANY CLEANERS, DE-LIMING AGENT OR DE-GREASER AS RECOMMENDED BY THE SUPPLIER. MANY ARE HARMFUL. READ THE WARNINGS AND FOLLOW THE DIRECTIONS!

EVEN WHEN THE UNIT HAS BEEN SHUT OFF, DON'T PUT HANDS OR TOOLS INTO THE COOKING CHAMBER UNTIL THE FAN HAS STOPPED TURNING.

DON'T USE ANY CLEANING OR DE-LIMING AGENT THAT CONTAINS ANY SULFAMIC AGENT OR ANY CHLORIDE, INCLUDING HYDROCHLORIC ACID (HCl). TO CHECK FOR CHLORIDE CONTENT SEE ANY MATERIAL SAFETY DATA SHEETS PROVIDED BY THE CLEANING AGENT MANUFACTURER.

UNIT MAY BE HOT. TAKE PRECAUTIONS TO PREVENT CONTACT WITH HOT SURFACES.

To clean the cooking chamber and/or de-lime the steam generator of the CC10-G or C/2-20G, a special sequence of operations (the Clean Cycle) has been programmed into the Convection Combo™ computer. To run this automatic Clean Cycle for cleaning, de-liming or both actions at the same time, follow the instructions outlined on the following page.

IMPORTANT

DO NOT USE ANY METAL MATERIAL (SUCH AS METAL SPONGES) OR METAL IMPLEMENTS (SUCH AS A SPOON, SCRAPER OR WIRE BRUSH) THAT MIGHT SCRATCH THE SURFACE. SCRATCHES MAKE THE SURFACE HARD TO CLEAN AND PROVIDE PLACES FOR BACTERIA TO GROW. DO NOT USE STEEL WOOL, WHICH MAY LEAVE PARTICLES IMBEDDED IN THE SURFACE WHICH COULD EVENTUALLY CAUSE CORROSION AND PITTING.

OM-CC-G and C/2-G

WARNING
DO NOT SPRAY OR CLEAN THE DOOR WHILE HOT. GLASS BREAKAGE MAY OCCUR IF THE DOOR IS RAPIDLY COOLED WITH WATER.

- f. Always check the jumper cord between the oven front panel and the door after cleaning. Make sure that it is properly positioned as shown to prevent damage.



2. Interior CLEANING STEPS

For the (2)CC-10G and (2)C/2-20G double-stacked units, the cleaning processes must be performed on each cavity. When double-stack units are being cleaned, wait five minutes after starting the first oven clean cycle (Time/Status display will show **CL:40**) before you start to clean the second cavity.

Clean Cooking Chamber Only	De-Lime Steam Generator Only	Clean Chamber and De-Lime Generator
Omit step 3	Omit step 2	Perform all steps in order

Before beginning this procedure, make sure the oven HOT light is not on. If the HOT light is on, use the FAST COOL instructions on page 18 to cool the oven cavity.



WARNING
UNIT MAY BE HOT. DO NOT TOUCH HOT SURFACES.
DO NOT PUT HANDS OR OTHER OBJECTS INTO COOKING CHAMBER WHILE CONVECTION COMBO™ IS OPERATING. THE ROTATING FAN CAN BE HAZARDOUS.

STEP 1

After cooling the oven to 200°F (90°C) or less, take the oven out of any mode in which it may have been operating. (Wait at least two minutes, or until the steam generator starts to fill, before adding a deliming solution.) Enter **99** into the timer. The Time/Status display will read **CC** or **CL**.



WARNING
BEFORE REACHING INTO THE OVEN TO REMOVE PARTITIONS, EXIT THE FAST COOL MODE BY PRESSING ANY BUTTON OR BY CLOSING AND REOPENING THE DOOR. DO NOT REACH IN THE OVEN UNTIL THE FAN HAS STOPPED MOVING.
OVEN MAY BE HOT — WEAR GLOVES OR USE OVEN MITTS TO AVOID BURNS.
DO NOT OPERATE THE UNIT IN ANY MODE UNLESS ALL FOUR REMOVABLE PARTITIONS HAVE BEEN RETURNED TO THEIR PROPER LOCATIONS.

STEP 2

Make sure to clean all food particles out of the drain.

On a daily basis, follow the degreaser supplier's instructions, and apply degreaser to the entire cooking cavity and pan racks.

Once a week, remove oven racks and partitions in order. Use an oven mitt if the oven is hot. To remove partitions:

Left — The left partition includes a back plate and an air distribution baffle. Lift up to disengage the four hooks from their support posts and remove the partition from the chamber (see pictures on next page).

Right — The right partition includes a large, circular, flared opening that is centered in front of the fan. Push upward to disengage the four hooks from their support posts and remove the partition from the chamber.

Bottom — The bottom partition has a small circular pattern of drain holes. Lift it directly up and off from its four support posts.

Top — The top partition is flat and has no holes. Remove it by pushing upward, then pushing from left to right to disengage the four hooks to their support posts.

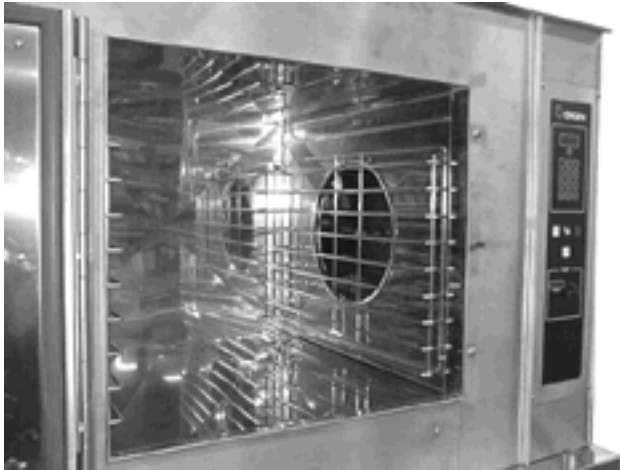

Cooking Chamber with Partitions in Place

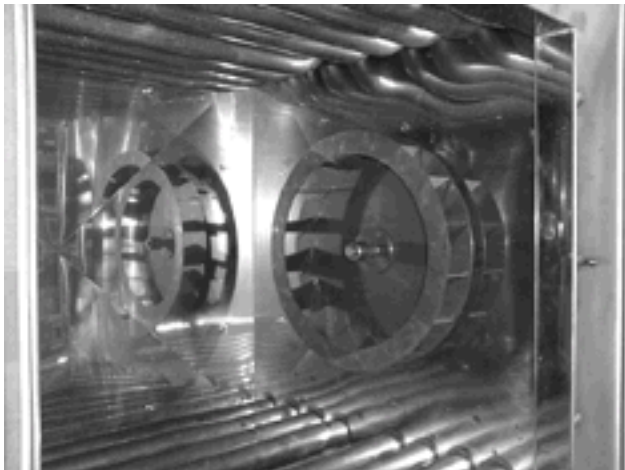

Cooking Chamber with Partitions Removed

STEP 2, Continued

Apply cleaner to the oven walls and heat exchange tubes. Apply it also to the rear of each removable partition.

Return the four partitions to their proper locations in the following order:

Top — The top partition is flat and has no holes. Install it by pushing upward, then pushing from right to left to engage the four hooks to their support posts.

Bottom — The bottom partition has a small circular pattern of drain holes. Place it directly down onto the four support posts.

Right — The right partition includes a large, circular, flared opening that must be centered in front of the fan. Push downward to engage the four hooks to their support

posts. **If absolutely necessary**, you may remove the wire rack support.

Left — The left partition includes a back plate and an air distribution baffle. Push down to engage the four hooks to their support posts. **If absolutely necessary**, you may disassemble the back plate, baffle and wire rack support.

FOR CAVITY CLEANING ONLY, GO TO STEP 4.

WARNING
DO NOT OPERATE THE UNIT IN ANY MODE UNLESS ALL FOUR REMOVABLE PARTITIONS HAVE BEEN RETURNED TO THEIR PROPER LOCATIONS.

STEP 3 (Deliming Only)

Water hardness affects the de-limer's performance. In very hard water, stronger solutions and more frequent applications of de-limer may be necessary. (Refer to Water Quality and Treatment on Page 6).

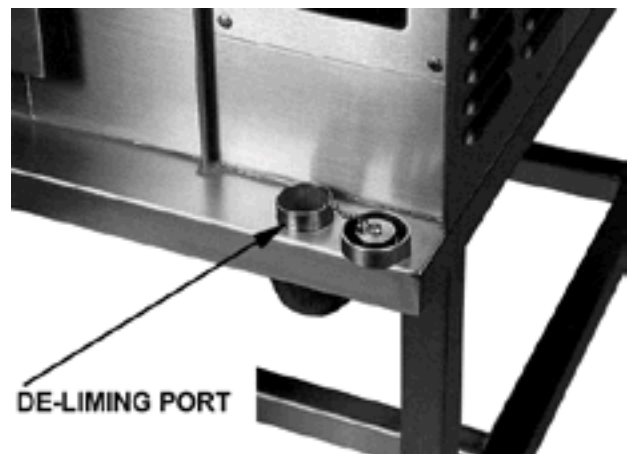

The deliming port is located directly below the control panel.



De-limer is poured through the port into the delimer reservoir.

OM-CC-G and C/2-G

Following the supplier's directions, pour de-liming solution into the de-liming port. If you use Groen Delimer Descaler (P/N 114800) pour in one pint (½ liter) (two pints for C/2-20G). Replace cap on the port.

Pour one cup (¼ liter) of liquid de-limer directly into the cooking chamber drain.

WARNING

IF THERE IS OVEN CLEANER ON OR NEAR THE OVEN FLOOR DRAIN, POUR ONLY A SMALL AMOUNT OF DE-LIMER AT FIRST TO SEE IF THERE IS A REACTION BETWEEN THE CLEANER AND THE DE-LIMER. DO NOT BREATHE ANY RESULTING FUMES.

STEP 4

Close the door and press **START**. The Time/Status display will read **CL:45**. The unit will then complete the cleaning cycle, counting down to **CL:00**. When double-stack units are being cleaned, wait five minutes after starting the first oven clean cycle (display will show **CL:40**) before you start to clean the second cavity.

If both cleaning and deliming, in about two minutes, the de-liming solution in the reservoir will be drawn into the steam generator. Remove the cap from the fill port and pour one quart of clean water into the reservoir. The water will also be drawn into the generator. Replace the cap.

NOTE: To exit the Clean Cycle at any time press and hold the **CLEAR** touch pad for three seconds.

After halting the Clean Cycle, and before you cook any food, be sure to thoroughly wash out all chemical residue by filling and draining the steam generator. (Enter Steam Mode and wait 60 to 90 seconds to fill; enter Oven Mode, take the unit out of all modes or simply turn it off to drain). Wait at least three minutes before restarting the unit.

Also wipe chemical residues from the cooking chamber with a wet, clean cloth before you cook anything. **Rinse the cloth often**. This cleaning must include **both sides** of the removable partitions, the racks, and the tubes and walls behind the partitions. The racks and partitions may be rinsed in a sink.

STEP 5

When the Clean Cycle is complete, turn off the oven and let it cool. Thoroughly wipe down the cooking cavity with clean water. If any baked-on residue is still present, use a nylon scrub pad and rinse again. **Make sure all degreaser is thoroughly wiped off oven door gaskets.**



WARNING

UNIT MAY BE HOT ENOUGH TO BURN YOU. DO NOT TOUCH HOT SURFACES.

Errors During Cleaning

If the timer stops and the SERVICE light stays on, there has been an error which prevents the unit from completing the clean cycle. Take the following steps:

- 1) Reset the unit. Re-enter "99." The Time/Status display should read "CC" or "CL." Press START.
- 2) If the unit fails again to complete its clean cycle, call your authorized Groen Service Agency.

Clean Cycle Counter

The unit tracks the total number of clean cycles completed. To check this total, first turn off the unit. Press and hold the 0 touch pad while turning on the unit. The total will be displayed in the Time/Status display.

Maintenance

The Groen Convection Combo™ is designed for minimum maintenance. Certain parts may need replacement after prolonged use. If there is a need for service, only Groen personnel or authorized Groen representatives should perform the work.

If steam or condensate is seen leaking from around the door, take the following steps:

1. Check the door gasket. Use a 2" strip of paper closed in between the door and the gasket. If the paper is not snugly held in place, adjust the latch pin as indicated in Step #3. Replace the gasket if it is cracked or split.
2. Inspect the cooking chamber drain to be sure it is not blocked.

3. Adjust the latch pin as follows:
 - a. Loosen the lock nut at the base of the latch pin, and turn the latch pin ¼ turn clockwise. Re-tighten the lock nut.
 - b. After adjustment, run the unit in the Steam Mode to test for further steam leaks.
 - c. If leakage continues, repeat the adjustment.
 - d. Continue adjusting the pin clockwise until the door fits tightly enough to prevent leaks.

Troubleshooting

A. Pilot Burner

Remember that the front control panel will not operate until the pilot switch has been activated and the pilot burner flame has been ignited (green light is on). For details, see Initial Start-Up on page 11. If the procedure described in Initial Start-Up has been followed and the pilot burner still does not light, contact your authorized Groen Service Agency.

B. Resetting the Solid State Controls

(If problems persist call an authorized Groen Service Agency)

If the controls stop responding to normal commands, or the unit is behaving oddly, reset the controls using the following procedure:

1. Switch off the power by pressing the **ON** touch pad.
2. While pressing the **COMBO** touch pad, switch the power back on. If no errors are present, the unit will beep and show four zeroes in the Time/Status display. If there are errors, the unit will **not** beep, but will display Service Codes, both in the Time/Status and Cook displays. **Note the Service Codes.** Press **CLEAR** to exit the Service Mode and refer to the following explanation of service messages.

C. Service Messages

There are two types of service messages:

1. Non-critical error: signaled by three quick beeps. The **SERVICE** light comes on for 15 seconds and then goes out.
2. Critical error: signaled by a continuous five second beep. The **SERVICE** comes on and stays on.

If there is a non-critical error you may continue to operate the unit. As soon as possible, check the Service Code. Turn off the unit by pressing the **ON** touch pad. While pressing the **COMBO** touch pad, switch the power back on. Note the numbers and refer to the Troubleshooting Guide which follows. Press **CLEAR** to exit the Service Mode.

If there is a critical error, the unit will not operate in its present mode, but it may operate in another mode. Check the Service Code as instructed above, then call your authorized Groen Service Agency.

If the problem continues after you follow the instructions in the Troubleshooting Guide, call your authorized Groen Service Agency.

Troubleshooting Guide

If a problem persists after taking the actions suggested below, call your authorized Groen service representative.

CODE	INDICATES	SUGGESTED ACTION
1	Low water level probe	Try cleaning steam generator to remove contamination from the probes. • If either code continues, call your Groen Service Agency. • If both codes are displayed, the unit will only operate in the Oven Mode. • If only one code is displayed, the unit will operate in all modes, but water may overflow from the generator into the cooking chamber during operations in either the Steam or Combo Modes.
2	High water level probe	
3	Maximum generator fill time (11 minutes) has been exceeded.	Make sure the water supply is fully turned on and that hoses are not kinked or pinched. • If the code is still displayed, the unit will operate in the Oven Mode only. • Call your Groen Service Agency
4	Faulty air probe	• The unit will operate in Steamer and Clean Cycle Modes only. • Call your Groen Service Agency
6	Faulty generator probe	• The unit will operate in Oven Mode only. • Call your Groen Service Agency
7	Time Between Fills	Check for a leaky fill valve. • The unit will operate in Oven Mode only. • Call your Groen Service Agency
8	Maximum generator drain time (3 minutes) has been exceeded.	Inspect the drain line and remove any blockage. Make certain that the drain is free-vented as detailed in the Installation Section of this Manual. (Paragraph 5, Page 8)

Will the Unit Operate? — After a Service Code Occurs

Will Convection Combo™ operate in _____ Mode when Code _____ is displayed?

Mode	Service Code							
	1	2	3	4	6	7	8	1 & 2
Steam	Yes	Yes	No	Yes	No	No	No	No
Combo	Yes	Yes	No	No	No	No	No	No
Oven	Yes	Yes	Yes	No	Yes	Yes	Yes	Yes
Clean	Yes	Yes	No	Yes	No	No	No	No

Door Light: The door has a total of four light bulbs, two pair wired in series. If the top or bottom two bulbs fail to operate, replace each bulb individually to isolate the failed bulb. If all bulbs fail to operate, check the installation of the jumper cord between the door and the oven front panel (see Step F and photo on page 20).

Diagrams & Schematics

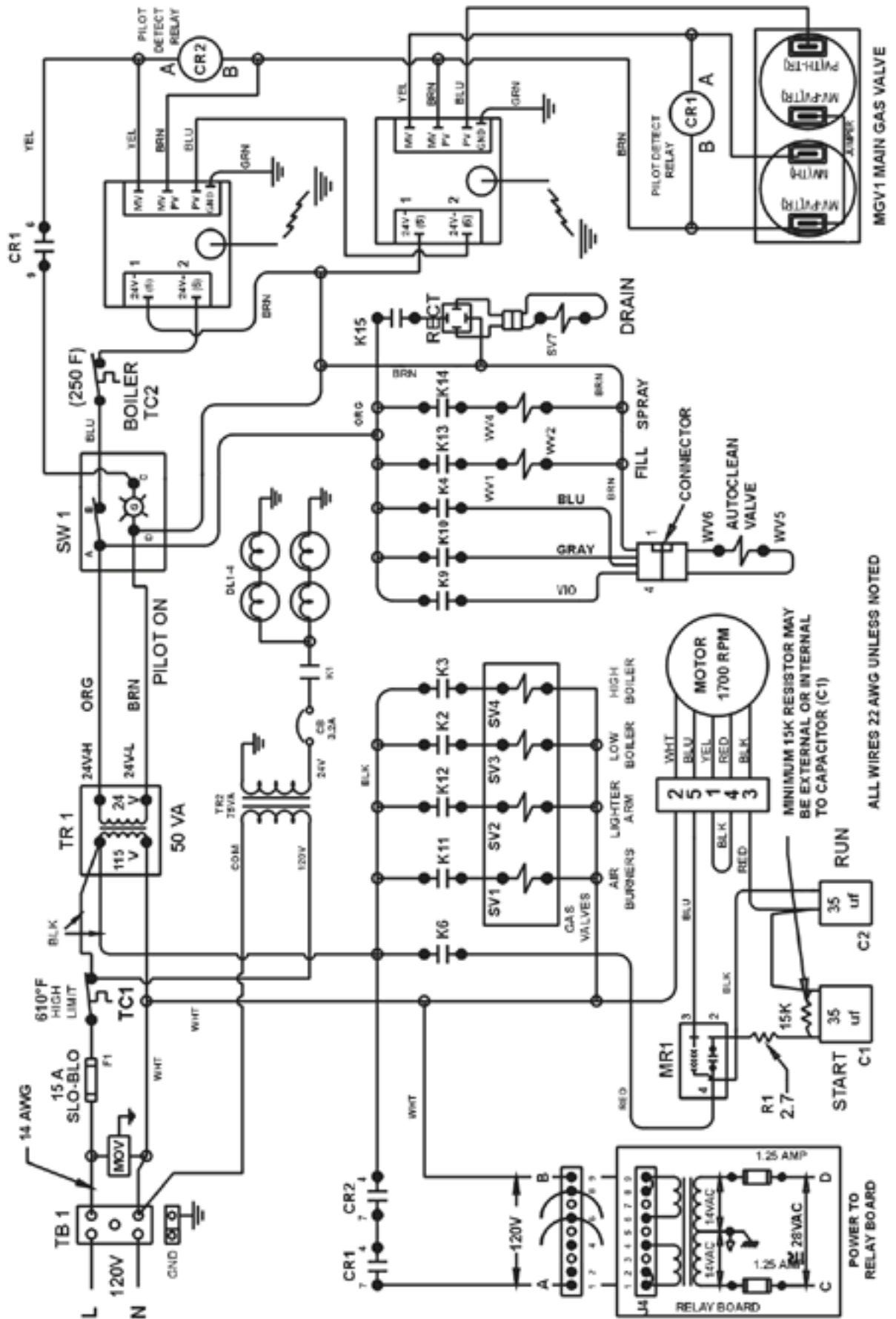

References

AMERICAN NATIONAL STANDARDS
INSTITUTE, INC.
1430 Broadway
New York, New York 10018

ECOLAB, Inc.
370 Wabash
St. Paul, Minnesota 55102
800 328-3663 or 612 293-2233

NATIONAL FIRE PROTECTION ASSOCIATION
60 Battery March Park
Quincy, Massachusetts 02269

NFPA/70 The National Electrical Code

NSF INTERNATIONAL
789 N. Dixboro Rd.
P.O. Box 130140
Ann Arbor, Michigan 48113-0140

UNDERWRITERS LABORATORIES, INC.
333 Pfingsten Road
Northbrook, Illinois 60062

ZEP MANUFACTURING
1310-T Seaboard Industrial Blvd.
Atlanta, GA 30318



1055 Mendell Davis Drive
Jackson, MS 39272
Telephone 601 372-3903
Fax 601 373-9587
www.groen.com

OM-CC-G and C/2-G
Part Number 121086 Rev. B