



**Henny Penny
Blast Chiller/Freezer
Models BCF-24/65/110
BCM-110**

OPERATOR'S MANUAL

[REGISTER WARRANTY ONLINE AT WWW.HENNYPENNY.COM](http://WWW.HENNYPENNY.COM)

LIMITED WARRANTY FOR HENNY PENNY EQUIPMENT

Subject to the following conditions, Henny Penny Corporation makes the following limited warranties to the original purchaser only for Henny Penny appliances and replacement parts:

NEW EQUIPMENT: Any part of a new appliance, except baskets, lamps, and fuses, which proves to be defective in material or workmanship within two (2) years from date of original installation, will be repaired or replaced without charge F.O.B. factory, Eaton, Ohio, or F.O.B. authorized distributor. Baskets will be repaired or replaced for ninety (90) days from date of original installation. Lamps and fuses are not covered under this Limited Warranty. To validate this warranty, the registration card for the appliance must be mailed to Henny Penny within ten (10) days after installation.

FILTER SYSTEM: Failure of any parts within a fryer filter system caused by the use of the non-OEM filters or other unapproved filters is not covered under this Limited Warranty.

REPLACEMENT PARTS: Any appliance replacement part, except lamps and fuses, which proves to be defective in material or workmanship within ninety (90) days from date of original installation will be repaired or replaced without charge F.O.B. factory, Eaton, Ohio, or F.O.B. authorized distributor.

The warranty for new equipment covers the repair or replacement of the defective part and includes labor charges and maximum mileage charges of 200 miles round trip for a period of one (1) year from the date of original installation.

The warranty for replacement parts covers only the repair or replacement of the defective part and does not include any labor charges for the removal and installation of any parts, travel, or other expenses incidental to the repair or replacement of a part.

EXTENDED FRYPOT WARRANTY: Henny Penny will replace any frypot that fails due to manufacturing or workmanship issues for a period of up to seven (7) years from date of manufacture. This warranty shall not cover any frypot that fails due to any misuse or abuse, such as heating of the frypot without shortening.

0 TO 3 YEARS: During this time, any frypot that fails due to manufacturing or workmanship issues will be replaced at no charge for parts, labor, or freight. Henny Penny will either install a new frypot at no cost or provide a new or reconditioned replacement fryer at no cost.

3 TO 7 YEARS: During this time, any frypot that fails due to manufacturing or workmanship issues will be replaced at no charge for the frypot only. Any freight charges and labor costs to install the new frypot as well as the cost of any other parts replaced, such as insulation, thermal sensors, high limits, fittings, and hardware, will be the responsibility of the owner.

Any claim must be presented to either Henny Penny or the distributor from whom the appliance was purchased. No allowance will be granted for repairs made by anyone else without Henny Penny's written consent. If damage occurs during shipping, notify the sender at once so that a claim may be filed.

THE ABOVE LIMITED WARRANTY SETS FORTH THE SOLE REMEDY AGAINST HENNY PENNY FOR ANY BREACH OF WARRANTY OR OTHER TERM. BUYER AGREES THAT NO OTHER REMEDY (INCLUDING CLAIMS FOR ANY INCIDENTAL OR CONSEQUENTIAL DAMAGES) SHALL BE AVAILABLE.

The above limited warranty does not apply (a) to damage resulting from accident, alteration, misuse, or abuse; (b) if the equipment's serial number is removed or defaced; or (c) for lamps and fuses. THE ABOVE LIMITED WARRANTY IS EXPRESSLY IN LIEU OF ALL OTHER WARRANTIES, EXPRESS OR IMPLIED, INCLUDING MERCHANTABILITY AND FITNESS, AND ALL OTHER WARRANTIES ARE EXCLUDED. HENNY PENNY NEITHER ASSUMES NOR AUTHORIZES ANY PERSON TO ASSUME FOR IT ANY OTHER OBLIGATION OR LIABILITY.

Revised 01/01/07

TABLE OF CONTENTS

Section	Page
Section 1. INTRODUCTION	1-1
1-1. Blast Chiller/Freezer	1-1
1-2. Features	1-1
1-3. Proper Care	1-1
1-4. Assistance	1-1
1-5. Safety	1-2
Section 2. INSTALLATION	2-1
2-1. Introduction	2-1
2-2. Unpacking	2-1
2-3. Electrical	2-2
2-4. Location	2-3
2-5. Refrigerant Information	2-4
2-6. Compressor size	2-4
2-7. Reversing Door Instructions	2-5
2-8. Operation Checklist	2-7
2-9. Refrigeration Capacities & Fan Speed	2-7
Section 3. OPERATION	3-1
3-1. Introduction	3-1
3-2. Operating Controls	3-1
3-3. Basic Operation	3-4
3-4. De-Icing	3-7
3-5. Cleaning	3-8
3-6. Seasonal or Prolonged Shutdown	3-9
3-7. Programming	3-10
Section 4. TROUBLESHOOTING	4-1
4-1. Troubleshooting Guide	4-1
4-2. Alarm Messages	4-2
GLOSSARY	G-1

Distributors List - Domestic and International

SECTION 1. INTRODUCTION

1-1. BLAST CHILLER/ FREEZER

The Henny Penny Blast Chiller/Freezers are designed to carry out fast refrigeration and freezing of food products. The units are electronically controlled for easy use and for consistent operation.

1-2. FEATURES

- Interior and exterior made of 304 stainless steel
- Electronic controls
- Manual de-icing of the interior
- Multi-sensored Frigiprobe food probe
- Easily maintained
- Automatic evaporation for de-icing water
- The BCF-24 chills up to 10.9 kg (24 lbs) of product
- The BCF-65 chills up to 29.5 kg (65 lbs) of product
- The BCF-110 chills up to 50 kg. (110 lbs) of product
- HACCP printer capabilities (optional)
- An auto back-up cycle in case of an air temperature probe failure

NOTICE

As of August 16, 2005, the Waste Electrical and Electronic Equipment directive went into effect for the European Union. Our products have been evaluated to the WEEE directive. We have also reviewed our products to determine if they comply with the Restriction of Hazardous Substances directive (RoHS) and have redesigned our products as needed in order to comply. To continue compliance with these directives, this unit must not be disposed as unsorted municipal waste. For proper disposal, please contact your nearest Henny Penny distributor.



1-3. PROPER CARE

As in any unit of food service equipment, the blast chiller/freezer does require care and maintenance. Requirements for the maintenance and cleaning are contained in this manual and must become a regular part of the operation of the unit at all times.

1-4. ASSISTANCE

Should you require outside assistance, call your local independent Henny Penny distributor in your area, call Henny Penny Corp. at 1-800-417-8405 toll free or 1-937-456-8405, or go to Henny Penny online at www.hennypenny.com.

1-5. SAFETY

The Henny Penny Blast Chiller/Freezer has many safety features incorporated. However, the only way to ensure a safe operation is to fully understand the proper installation, operation, and maintenance procedures. The instructions in this manual have been prepared to aid you in learning the proper procedures. Where information is of particular importance or safety related, the words DANGER, WARNING, CAUTION, and NOTICE are used. Their usage is described below.



SAFETY ALERT SYMBOL is used with DANGER, WARNING, or CAUTION which indicates a personal injury type hazard.



NOTICE is used to highlight especially important information.



CAUTION used without the safety alert symbol indicates a potentially hazardous situation which, if not avoided, may result in property damage.



CAUTION used with the safety alert symbol indicates a potentially hazardous situation which, if not avoided, may result in minor or moderate injury.



WARNING indicates a potentially hazardous situation which, if not avoided, could result in death or serious injury.



DANGER INDICATES AN IMMINENTLY HAZARDOUS SITUATION WHICH, IF NOT AVOIDED, WILL RESULT IN DEATH OR SERIOUS INJURY.

SECTION 2. INSTALLATION

2-1. INTRODUCTION

This section provides the installation for the Henny Penny Blast Chiller/Freezer.

NOTICE

Installation of this unit should be performed only by a qualified service technician.



Do not puncture the unit with any objects such as drills or screws, or component damage or electrical shock could result.

2-2. UNPACKING

The Henny Penny Blast Chiller/Freezer has been tested, inspected, and expertly packed to ensure arrival at its destination in the best possible condition. The rack supports are secured inside the unit with cardboard, and the slides for the racks are packed inside the unit. The cabinet rests on a wooden skid and is then packed inside a heavy cardboard carton with sufficient padding to withstand normal shipping treatment.

CAUTION

To avoid damage to the components, do not lay the unit on its side. If the unit has been on its side, the unit must be in an upright position for at least an hour before power is applied to the unit.

Check all components for signs of being loose or damaged, and make sure the system has refrigerant.

NOTICE

Any shipping damage should be noted in the presence of the delivery agent and signed prior to his or her departure.

To remove the Henny Penny Blast Chiller/Freezer from the carton, you should:

1. Carefully cut banding straps.
2. Lift the carton off the unit.
3. Lift the unit off the skid.

2-2. UNPACKING
(Continued)



The BCF-24 weighs about 250 lbs (112.5 kg), the BCF-65 about 340 lbs (153 kg), and the BCF/BCM-110 about 364 lbs (165 kg). Care should be taken when lifting unit to prevent personal injury.

4. Open door and remove packing from racks and the horizontal slides from the inside of the unit.
5. Peel off any protective covering from the exterior of the cabinet.
6. Install the slides onto the vertical racks.
7. Your blast chiller/freezer is now ready for operation.

2-3. ELECTRICAL

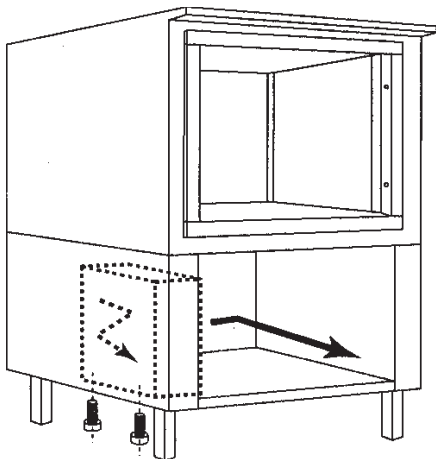

Electrical Box Location

The blast chiller/freezer is available as a 208, 230, or 200 VAC, 50 or 60 Hz, single phase unit, both for domestic and international use. The data plate, located on the left side of the unit, will specify the correct electrical supply. The BCF-24 and 65 are shipped with a 6 foot, 7 inch (2 m) cord and plug, and requires a grounded receptacle with a separate electrical line protected by a fuse or circuit breaker of the proper rating. The NEMA number for the plug is NEMA 6-20P.



This unit must be adequately and safely grounded. Refer to local electrical codes for correct grounding procedures. If unit is not adequately grounded, electrical shock could result.

To avoid electrical shock, this appliance must be equipped with an external circuit breaker which will disconnect all ungrounded (unearthed) conductors.

Refer to the table below for electrical ratings:

Model No.	Volts	Watts	Amps	Freq.	Phase
BCF-24	208-240	2300	4.3	60	1
	230	1800	9	50	1
	200	1800	11	50	1
BCF-65	208-240	3000	7	60	1
	230	2900	13	50	1
	200	2500	12	50	1
BCF-110 and BCM-110	208-240	4600	17	60	3
	400	3100	9	50	3
	200	3800	17	50/60	3

2-4. LOCATION

The BCF-24, BCF-65, and BCF/BCM-110 should be placed in an area where the doors can be opened, for loading and unloading, without interruption.

For proper operation, and the door to seal properly, the cabinet must be level, and can be leveled by means of the adjustable legs.

For maximum efficiency, if the air temperature of the premises is more than 100° F (38° C), the room should have adequate ventilation, taking into account for the heat emitted by the unit.

Minimum clearances around the unit, especially from sources of heat, are shown in the diagrams below:

BCF-24

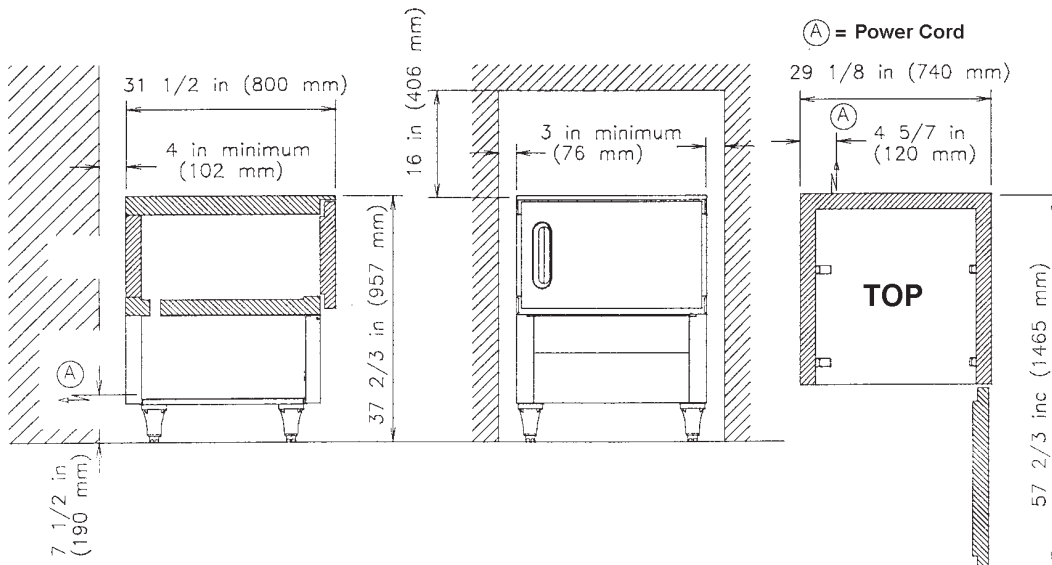

BCF-65

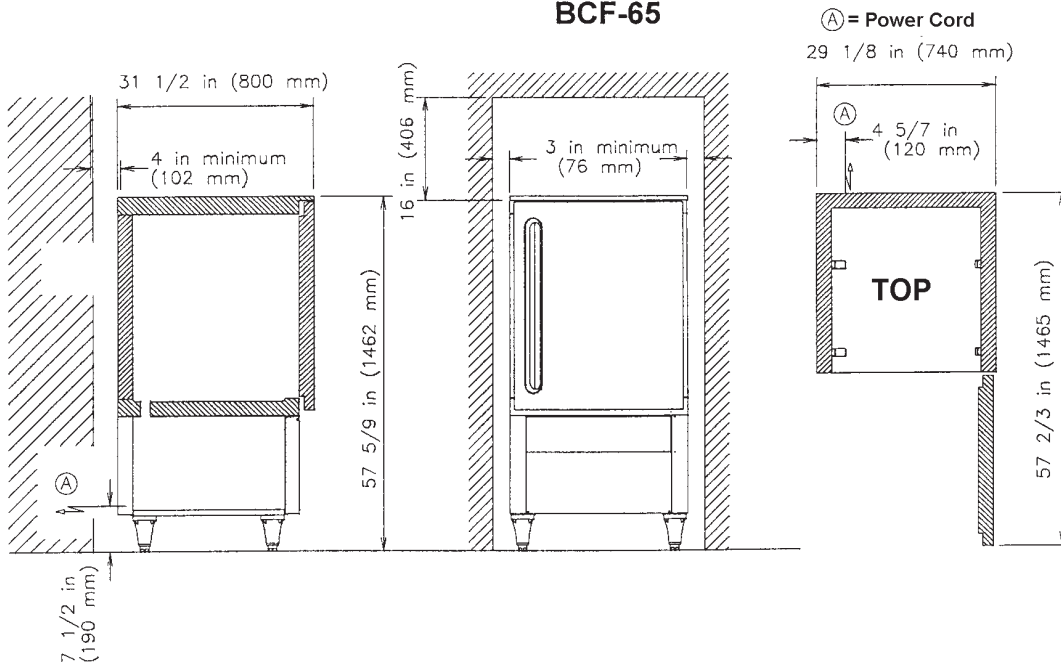

2-4. LOCATION (Continued)

BCF/BCM-110

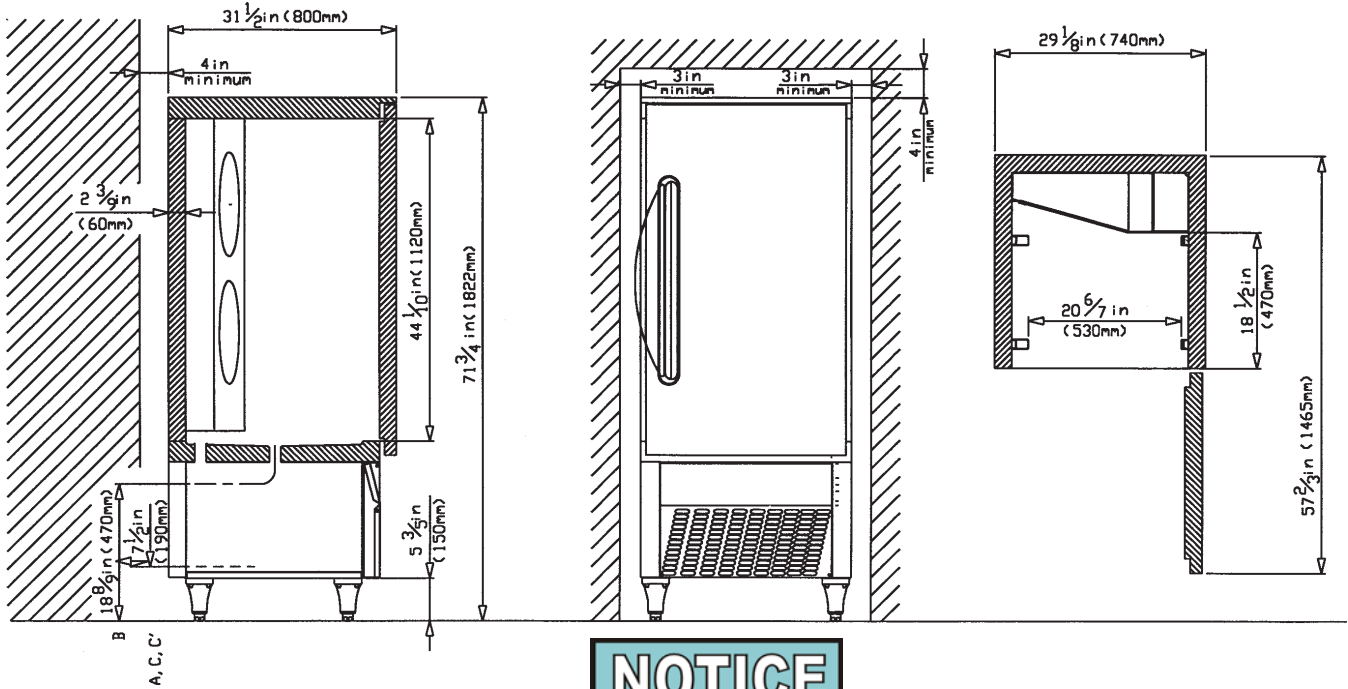

The models BCF-110 and BCR-110 require a 1 inch (25 mm) drain line.

2-5. REFRIGERANT INFORMATION

	Refrigerant Type	Amount of Refrig.	Design Pressure	
			High	Low
BCF-65	R404A	3.3 lbs (1.5 kg)	345 psig (23.8 bar)	190psig (13.1 bar)
BCF-24	R404A	2.4 lbs (1.1 kg)	335 psig (23.1 bar)	195 psig (13.4 bar)
BCF-110/ BCM-110	R404A	3.3 lbs (1.5 kg)	425 psig (29.3 bar)	174 psig (12.0 bar)

2-6. COMPRESSOR SIZE

BCF-24
.75 Horsepower

BCF-65
1.5 Horsepower

BCF/BCM-110
2.5 Horsepower

2-7. REVERSING DOOR
INSTRUCTIONS

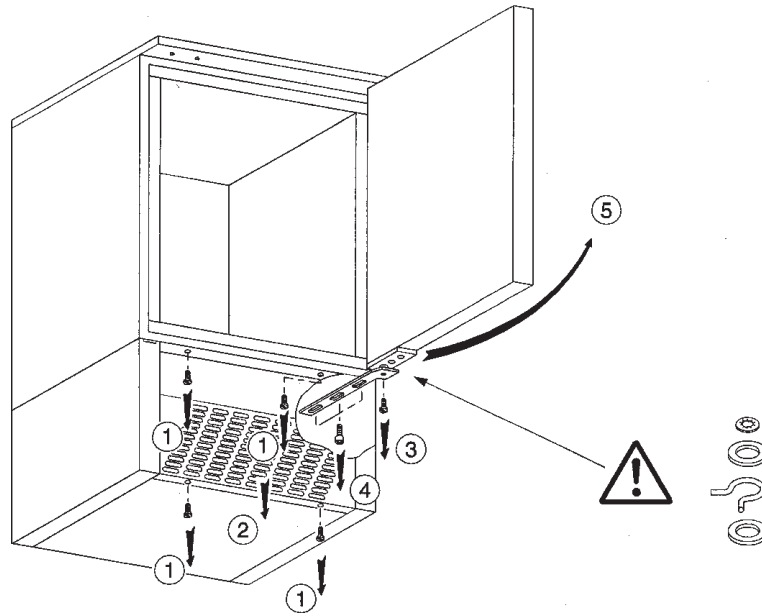

STEP 1

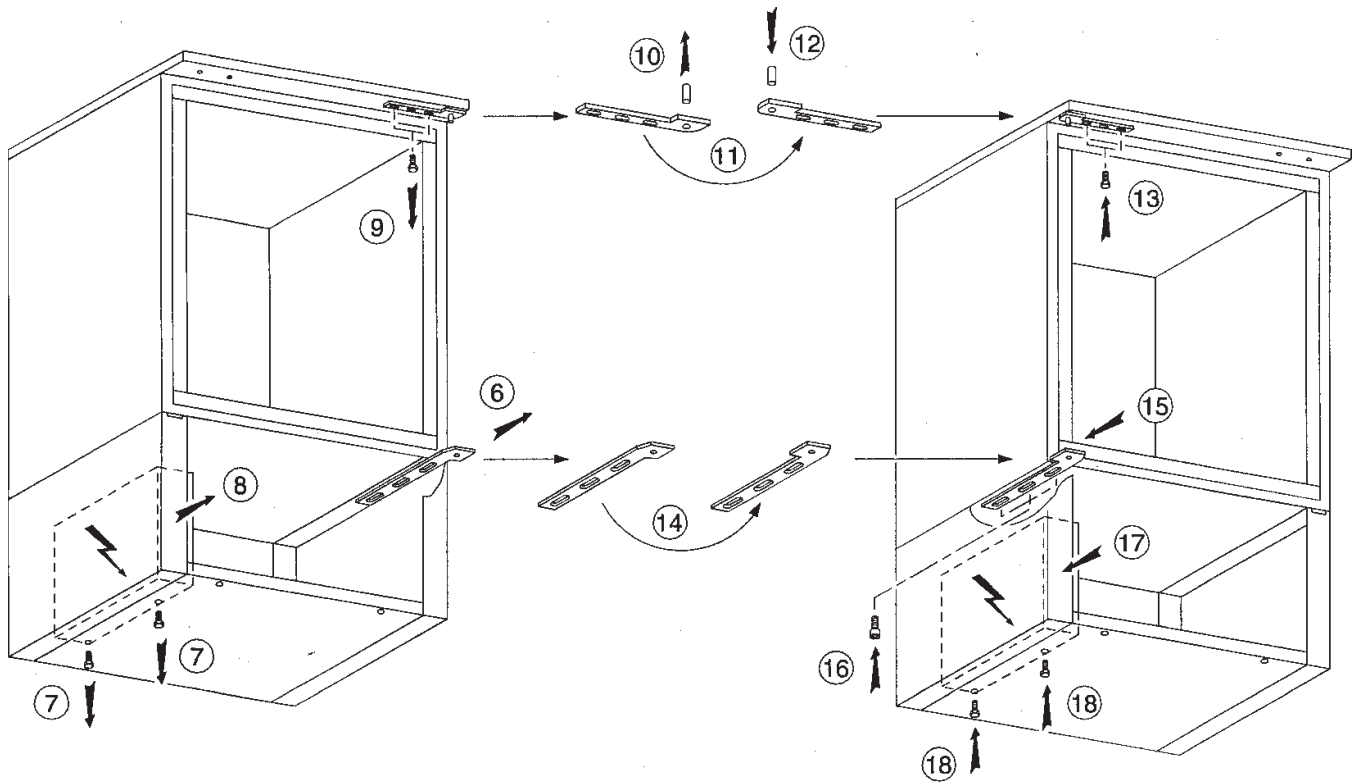

STEP 2

**2-7. REVERSING DOOR
INSTRUCTIONS (Continued)**

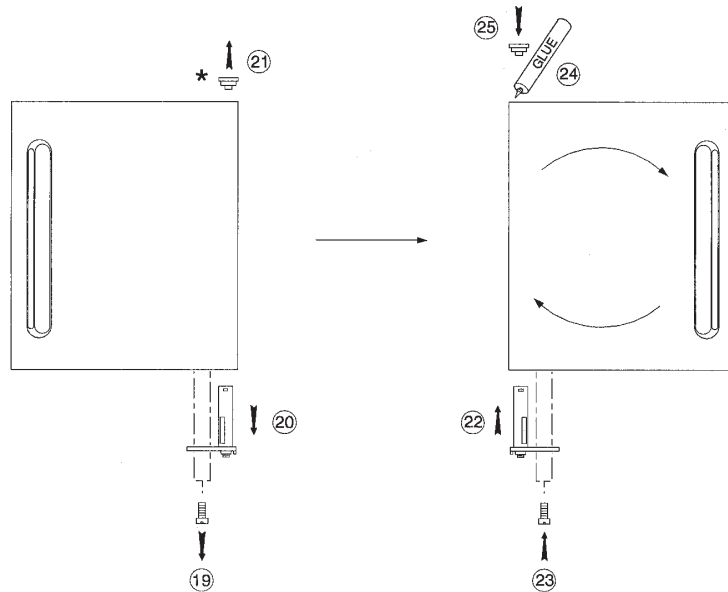

* FX95052577

STEP 3

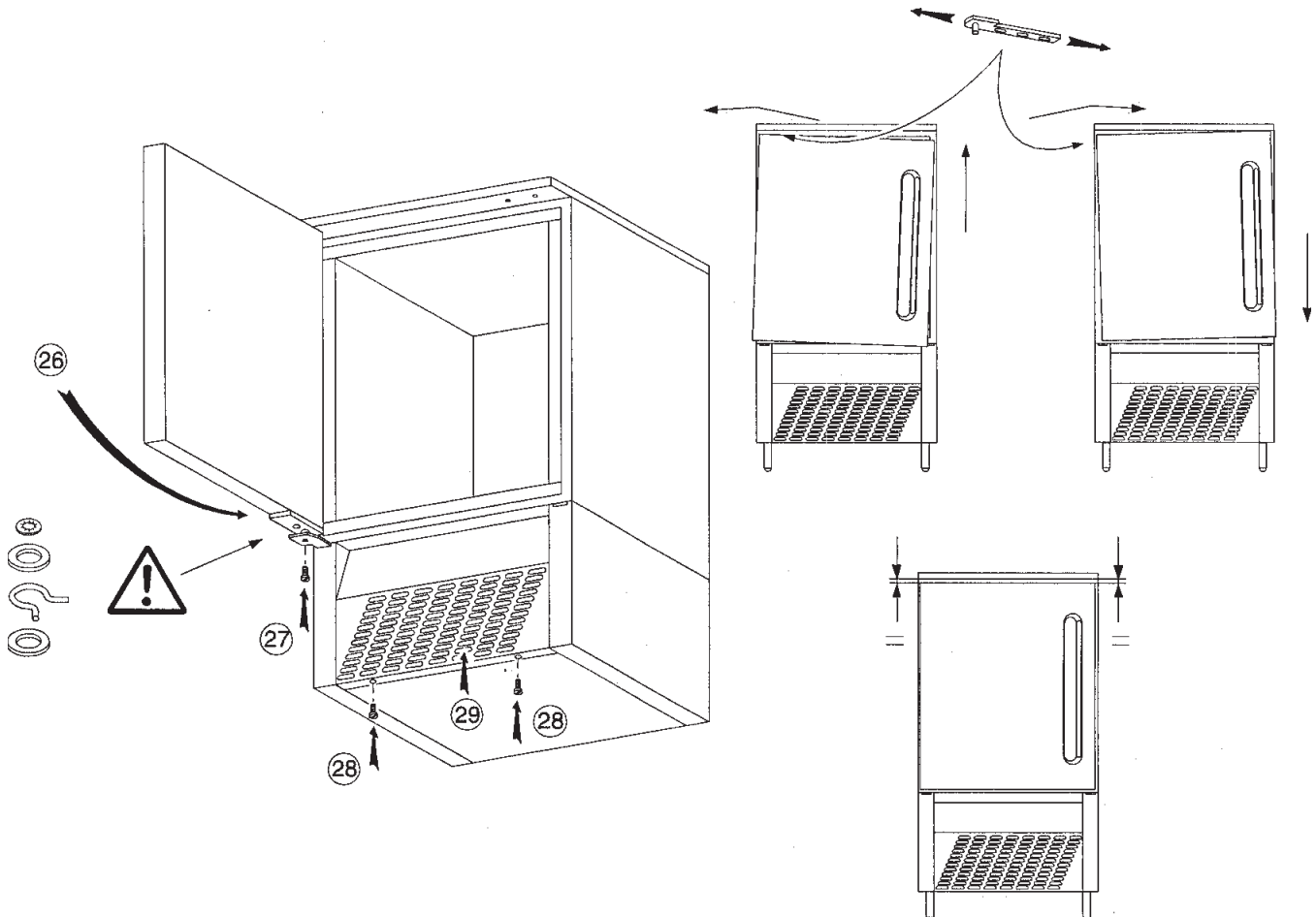

STEP 4

2-8. OPERATION CHECKLIST

Using a container 4 inches (100 mm) deep, filled with hot water, insert the Frigiprobe into the water and start the unit in the chilling mode. Refer to the graph at left.

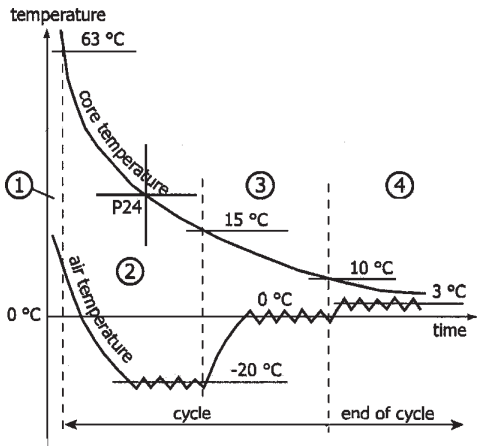

- The water temperature is probably below 145°F (63°C), so phase 1 won't be seen. The unit goes directly to phase 2.
- In phase 2, check that the compressor is regulating the air temperature limitation at around -4°F (-20°C). Use P02 information to read the air temperature, page 3-10.
- In phase 3, check that the compressor is regulating the air temperature limitation at around 32°F (0°C). Use P02 information to read the air temperature, page 3-10.
- In phase 4, check that the compressor is regulating the air temperature limitation at around 37°F (3°C). Read the air temperature directly from the display.

2-9. REFRIGERATION CAPACITIES & FAN SPEED

BCF-24

1000 W (3410 Btu/hr) at -4°F (-20°C) evaporation temperature
350 W (1190 Btu/hr) at -40°F (-40°C) evaporation temperature
2950 RPM evaporator fan

BCF-65

1150 W (3930 Btu/hr) at -4°F (-20°C) evaporation temperature
400 W (1370 Btu/hr) at -40°F (-40°C) evaporation temperature
2950 RPM evaporator fan

BCF/BCM-110

3500 W (11900 Btu/hr) at -4°F (-20°C) evaporation temperature
1000 W (3400 Btu/hr) at -40°F (-40°C) evaporation temperature
2950 RPM evaporator fan

SECTION 3. OPERATION

3-1. INTRODUCTION

This section provides operating procedures for the blast chiller/freezer. Sections 1, 2, and 3 should be read, and all instructions should be followed before operating the cabinet.

This section contains an explanation of all controls and components and information on operating procedures and daily maintenance.





CAUTION

To avoid damage to the components, do not lay a unit on its side if it has a compressor. If the unit has been on its side, the unit must be in an upright position for at least an hour before power is applied to the unit.

Check all components for signs of being loose or damaged, and make sure the system has refrigerant.

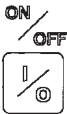

















3-2. OPERATING CONTROLS

Refer to Figure 3-1 of this section.

Fig. No.	Item No.	Description	Function
3-1	1		The ON/OFF button, when pressed, starts a Chilling Cycle; it also must be pressed before any changes to the controls can be made, and to start and stop the De-icing Cycle
3-1	2	Digital Display	Shows the temperatures, the time (in a timer cycle), and the information in the Technical Mode
3-1	3	 	The up and down arrows are used when changing times or settings
3-1	4		The alarm button is used to stop the optional alarm buzzer and to enter the Technical Mode
3-1	5		The TEMP button is used to select either the Chilling or Freezing Mode

3-2. OPERATING CONTROLS

(Continued)

Fig. No.	Item No.	Description	Function
3-1	6		The De-ice button is used to remove ice that may have formed on the evaporator during a Chilling or Freezing Cycle
3-1	7		The SELECT button is used to choose between a Timer Cycle or a cycle using the Frigiprobe
3-1	8	FAN  	The FAN LED is a green light which illuminates when the fan is running
3-1	9	COMPRESSOR  	The Compressor LED is a green light which illuminates when the compressor is running
3-1	10	END OF CYCLE 	The END-OF-CYCLE LED is a green light which illuminates at the end of a Timer Cycle or Frigiprobe Cycle
3-1	11	ALARM  	The Alarm LED is a red light which illuminates when the unit senses a fault in the system (ex: AL 1, AL 2, etc.)
3-1	12	40°F 4°C  	The chill LED is a green light which illuminates when the Chilling Mode is selected
3-1	13	0°F -18°C  	The freeze LED is a green light which illuminates when the Freezing Mode is selected
3-1	14	 	The de-Ice LED is a green light which illuminates when the De-ice button is pressed
3-1	15	 	The timer LED is a green light which illuminates when the Timer Cycle is selected
3-1	16	 	The Frigiprobe LED is a green light which illuminates when the Frigiprobe Mode is selected

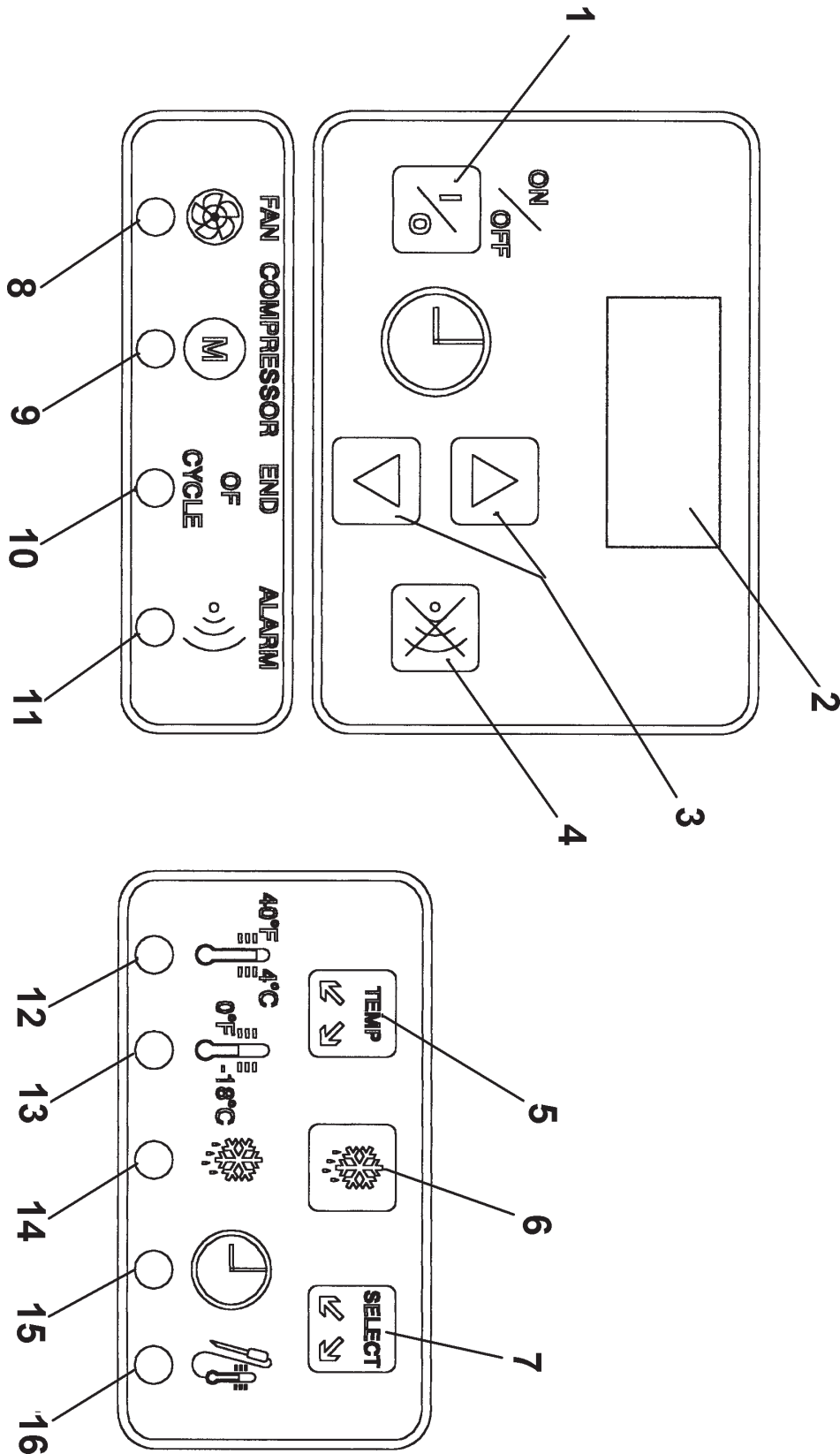

Figure 3-1. Operating Controls

3-3. BASIC OPERATION

The Henny Penny blast chiller/freezer chills food products with a core temperature of 149°F (65°C), down to 39°F (4°C) within 4 hours. They also freeze food products with a core temperature of 149°F (65°C), down to 0°F (-18°C) within 4 hours and 30 minutes, (room ambient temperature may impact time it takes to reach the desired temperature). For the best performance, see conditions below:

- a. The food product must not be thicker than 1-1/2 to 1-3/4 inches (40 to 45 mm).
- b. Meats should be placed directly onto the racks, but products in pans should be covered if possible. The steam from the product can form ice on the evaporator, which increases the chilling or freezing time.
- c. A minimum clearance of 1 inch (25 mm) between pans.
- d. The best dishes or pans to use are stainless steel or aluminum. Do not use polycarbonate (plastic) pans. The polycarbonate acts as an insulator around the food product and makes it hard to chill.
- e. Do not exceed the product weight capacity specified by the particular model of blast chiller.



MODEL	Chill Capacity	Freeze Capacity
BCF-24	24 lb. (10.8 kg)	16 lb. (7 kg)
BCF-65	65 lb. (29.5 kg)	32 lb. (15 kg)
BCF/BCM-110	110 lb. (50.0 kg)	55 lb. (25 kg)

Start-up

1. For the same batch of product (same type of product), load all the product at one time, so the door does not need to be opened while in operation.

For a mixed batch (different types of product), load each type as ready, and place the Frigiprobe (located on the left side, middle of the unit) into the product which will chill the quickest.





2. If using the Frigiprobe for same batch of product, place probe into product at this time.

3. Press  to turn unit on.  and  should come on after 25 seconds.

3-3. BASIC OPERATION
(Continued)

4. Press  to select the Chilling Mode or the Freezing Mode.

NOTICE



 or  and  or  , stay on with  turned to the OFF position.

5. Press  to choose the Frigiprobe Mode or the Timer

Mode. With the Probe Mode selected, the digital display alternately shows the core temperature of the product, and the elapsed time of the cycle. If the Timer Mode is selected, the digital display alternately shows the air temperature and the time (hours and minutes) remaining in the cycle.

NOTICE

The buzzer sounds 1 minute after the Probe Mode is selected, unless the temperature is above 140°F (60°C). Then the buzzer sounds when 140°F (60°C) is reached.

6. Set the time in the Timer Cycle, if necessary, using   . The time is affected by the thickness of the food product, weight, food loading temperature, and food's packaging. The buzzer sounds 1 minute into the Timer Cycle.

NOTICE

Avoid opening the door once the cycle has started. This lengthens the time it takes to reach the desired temperature.

7. At the end of the cycle (40°F (4°C) in the Probe Mode) the buzzer sounds and the unit automatically starts the Hold Cycle. The buzzer sounds for 30 seconds, or press  to stop it. In the Hold Cycle, the product will be held at 37°F (3°C) in the Chilling Mode, or at -0.4°F (-18°C) in the Freezing Mode.
8. The product can remain in the unit for up to 12 hours, or can be removed from the unit and placed in a cold storage case.

3-3. BASIC OPERATION
(Continued)



A temperature conversion chart is provided for your convenience:

Temperature Conversion Chart

88°C	190°F
80°C	176°F
70°C	158°F
65°C	149°F
60°C	140°F
50°C	122°F
40°C	104°F
30°C	86°F
10°C	50°F
4°C	40°F
0°C	32°F
-10°C	14°F
-20°C	-4°F
-30°C	-22°F
-40°C	-40°F

3-4. DE-ICING

Henny Penny recommends performing the de-icing process after every 3 cycles and at the end of each day. This eliminates any ice that may have formed around the evaporator during the Chilling or Freezing Cycles. Failure to follow this procedure increases the time it takes to cool the product and may lead to unsafe product.

1. Remove all product from the unit.
2. Open the door.
3. Press  to turn the unit on.
4. Press . The digital display now shows d. 01 . The compressor will not come on, but the evaporator fan comes on and pulls warm air created by the de-icing elements, across the evaporator.
5. Allow the De-ice Cycle to run for a minimum of 10 minutes and a maximum of 25 minutes. The unit automatically turns off when the evaporator has been de-iced, and reaches a temperature of 77°F (25°C).

NOTICE

If the above procedures does not remove all the ice from the evaporator, the length of time, and the temperature at which the De-ice Cycle turns the unit off can be adjusted. See the Programming Section.

3-5. CLEANING

Daily:

1. Make sure the power switch is in the off position.
2. Remove all product from the unit.
3. Remove the racks and pans from the unit and clean with soap and water at a sink.
4. Clean all surfaces, including the Frigiprobe, with a soft cloth, soap and water. Do not use abrasive cleaners!

CAUTION

Do not use steel wool, other abrasive cleaners or cleaners/sanitizers containing chlorine, bromine, iodine or ammonia chemicals, as these will deteriorate the stainless steel, and glass material, and shorten the life of the unit.

Do not use a water jet (pressure sprayer) to clean the unit, or component failure could result.

5. Clean around the electronic controls and the door seal with a soft, damp cloth.
6. The unit is now ready for operation.

NOTICE

Henny Penny has the following cleaners available:

Foaming Degreaser - Part no. 12226

Food Service Sanitizer - Part no. 12059

Stainless Steel Cleaner/Polish - Part no. 12060

See your local distributor for details.

Weekly:

Once a week, the evaporator coils need cleaning to ensure the unit runs efficiently and to remove corrosive build-up on the coils.



To avoid personal injury, move the power switch to OFF and unplug the power cord from the wall, or disconnect main circuit breaker.

Wear protective gloves to reduce the risk of cuts from the coil.

1. Remove the racks and pans from the unit
2. Using a flat-head screwdriver, remove the screws securing the evaporator cover and swing the cover out to access the coils.

3-5. CLEANING (Continued)

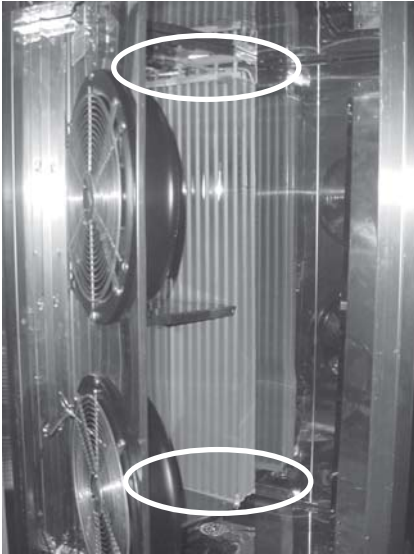

- Mix a bicarbonate of soda solution (baking soda) of one teaspoon per litre of water in a spray bottle. Spray the coils completely, concentrating on the top and bottom areas as shown in photo at left. Allow to soak for about 5 minutes.

CAUTION

Do not use a water jet (pressure sprayer) to clean the unit, or component failure could result.

Do not use pointed or sharp objects to cleaning coils or damage to the coil could result.

- Using a soft cloth or sponge and fresh water, rinse and clean the coils completely.
- Replace screws in cover and unit is now ready for use.

Monthly:

At least once a month the air condenser needs to be cleaned of dust or obstructions for the unit to run efficiently and to reduce energy use of the unit.



- Remove all electrical power supplied to the unit by unplugging the power cord from the wall, or by turning off the wall circuit breaker.
- Using a flathead screwdriver, remove the screws from the front panel of the unit. Pull panel down and press in on the side of the panel to release the tabs, and remove the panel from the unit.
- Use a vacuum cleaner, or soft brush to remove the dust, or other obstructions from the condenser.
- Finish cleaning with compressed air if possible, blowing the air from the rear of the condenser.

CAUTION

Do not use a wire brush to clean the condenser, or damage to the condenser could result.

- Replace the front panel, and reconnect the electrical supply, and unit is now ready for use.

3-6. SEASONAL OR PROLONGED SHUTDOWN

- Remove all electrical power supplied to the unit by turning off the wall circuit breaker.
- Make sure the inside of the unit is clean and completely dry.
- Leave the door slightly ajar to prevent smells from developing inside the unit.

3-7. PROGRAMMING

Information about the operation settings can be accessed by pressing . These settings can also be changed while in the different steps. The following information can be accessed:

NOTICE

After pressing , a delay occurs before the desired number appears in the display, and the number in the left column shows for 2 seconds. You then only have 12 seconds to change the setting.

Displayed Step

00

Not Available at this time.

01

Not Available at this time.

02





Internal air temperature. Press  three times and the digital display shows the air temperature during a Probe Cycle.

03

Evaporator temperature. Press  4 times and the digital display shows the evaporator temperature during the De-icing Cycle.

04

Type of program setting indicated by the jumper link located on the control board. Press  5 times and



APPLICATION	Jump link position	Code N°
Blast Chiller without frigiprobe (Quick Freezing operation impossible)		5
Blast Chiller with frigiprobe (Quick Freezing operation impossible)		6
Blast Chiller / Freezer (mixed) without Frigiproge		8
Blast Chiller / Freezer (mixed) with Frigiproge		9

the digital display shows a number between 5 and 9, which indicates the position of the jumper on the control board. The control panel area does not have to be accessed to obtain the information. (See chart at left.) Henny Penny controls should show a 6 in the display.

3-7. PROGRAMMING
(Continued)



Displayed Step

05



Temperature of the Holding Cycle, after the Chilling or Freezing Cycle. Press  6 times and the digital display shows the air temperature. This is the temperature the unit stays at during the Hold Cycle. The holding temperature can be changed at this time by using  .

Factory setting for air temperature is 37°F (3°C) in the Chilling Mode and 0°F (-18°C) in the Freezing Mode. The minimum temperature setting is 32°F (0°C) in the Chilling Mode and -31°F (-35°C) in the Freezing Mode. The maximum is 50°F (10°C) in the Chilling Mode and 32°F (0°C) in the Freezing Mode.

06



Maximum duration of De-icing Cycle (minutes). Press  7 times and the digital display shows the time duration of the De-icing Cycle. The factory setting is 25 minutes, but this can be changed to a maximum setting of 60 or a minimum of 25 by using  .

07

Evaporator temperature for the end of De-Icing Cycle. Press  8 times and the digital display shows the evaporator temperature at which the controls automatically turn off the De-icing Cycle. The factory setting is 77°F (25°C), but this can be changed to a maximum setting of 104°F (40°C) or the minimum of 50°F (10°C) by using  .



08

Temperature differential before high air temperature alarm. Press  9 times and the digital display shows the number of degrees, above the holding temperature, at which an alarm sounds, indicating the hold temperature is too high.

The factory air temperature setting is 27°F (-3°C), but can be changed to a maximum setting of 54°F (12°C) or a minimum temperature of 7°F (14°C) by pressing  .

09

Temperature differential before low air temperature alarm. Press  10 times and the digital display shows the number of degrees below the holding temperature, at which an alarm sounds, indicating the hold temperature is too low.

The factory air temperature setting is 27°F (-3°C), but can be changed to a maximum setting of 54°F (12°C) or a minimum of 18°F (-8°C) by pressing  .



3-7. PROGRAMMING
(Continued)

Displayed Step

10

The duration of time the temperatures (in 9 and 10 above) must remain at before the alarms will sound.

Press  11 times and the digital display shows the time at which the high and low temperatures (no. 9 and 10 above) must remain before the alarm sounds.

The factory setting is 20 minutes, but can be changed to a maximum setting of 60 minutes or a minimum of 10 minutes by pressing  .



This means that the temperature must remain at a too high or too low temperature for 20 minutes before an alarm sounds.

11

International Only. A Frigiprobe temperature at which the compressor turns off in a Chilling Cycle, to prevent freezing of the product. Press  12 times and the digital display shows the temperature at which a sensor in the Frigiprobe turns off the compressor during a Probe Mode. This prevents the outer surfaces of the product from freezing; however, the cooling time will be greatly increased.

The factory setting is 39°F (4°C), but can be changed to a maximum setting of 122°F (50°C) or a minimum of 32°F (0°C) by pressing  .





NOTICE

Do not change this setting lower than the setting used in parameter 22, (next page).

This function will only activate when the factory setting is changed to above 40°F (4°C). England must have a setting of 3°C (37°F).

12

Re-initialize the controls to factory settings. Press the  13 times and the digital display shows “dEF”, at which time  is pressed and the unit shuts down. Re-initialization is now complete.

NOTICE

After re-initialization, the controls default back to factory settings. The temperature will be in Celsius and the values in steps 12, 16, and 18 of this section need to be checked to be accurate for the country in which the unit is installed.

3-7. PROGRAMMING
(Continued)

Displayed Step

20

Blast chilling, low side air temperature limit, when using the Frigiprobe, in step 12 of this section. Press  14 times and the low side air temperature, at which the compressor cycles on and off, shows in the display. This temperature is used in preventing the product from freezing, while in the Chilling Mode, which is described in step 12.

The factory setting is -4°F (-20°C), but can be changed to a maximum setting of 32°F (0°C), and a minimum setting of -31°F (-35°C), by using  .



21

Blast chilling, high side air temperature limit, when using the Frigiprobe, in step 12 of this section. Press  15 times and the high side air temperature, at which the compressor cycles on and off, show in the display. This temperature is used in preventing the product from freezing, while in the Chilling Mode, which is described in step 12.

The factory setting is 32°F (0°C), but can be changed to a maximum setting of 50°F (10°C), and a minimum setting of 23°F (-5°C), by using  .



22

Frigiprobe, end of cycle temperature setting. Press  16 times, and the temperature at which ends the Probe Cycle and starts the Hold Cycle, shows in the display.

The factory setting is 39°F (4°C) for blast chilling and 0°F (-18°C) for blast freezing. The blast chilling is factory set at the maximum setting, but can be changed to a minimum setting of 32°F (0°C), by using  .



The blast freezing temperature can be changed to a maximum temperature of 32°F (0°C), and a minimum temperature of -31°F (-35°C), by using  .



NOTICE

The maximum settings for U.S.A. is **39°F (4°C)**, and for England is **37°F (3°C)**.

3-7. PROGRAMMING
(Continued)

Displayed Step

23

Frigiprobe temperature for when the buzzer sounds at the start of a cycle. Press  17 times, and the temperature that the buzzer sounds when the product has reached the “danger zone” temperature, and must be cooled to a “safe” temperature within the recommended time, is shown in the display.

The factory setting is 140°F (60°C), but can be changed to a maximum setting of 176°F (80°C) and a minimum setting of 122°F (50°C) by using  .



NOTICE

The settings for the U.S.A. must be 140°F (60°C) and for England, 158°F (70°C).

24

Intermediate Printer Setting. Press  18 times and a printing temperature, between the starting temperature and the ending temperature, can be set. Along with printing the temperature information at the end of a cycle, the printer can be set to capture temperature information in the middle of the cycle.



The factory setting is -40°F (-40°C), but can be changed to a maximum setting of 176°F (80°C) and a minimum setting of 40°F (-40°C) by using  .



NOTICE

A setting lower than parameter **22** deactivates this function.

30

Selecting Fahrenheit or Celsius. Press  19 times and °F or °C shows in the display. Press  to change from °F to °C, or vice versa. (Once  is pressed, the display goes blank.)



SECTION 4. TROUBLESHOOTING

4-1. TROUBLESHOOTING GUIDE

PROBLEM	CAUSE	CORRECTION
The evaporator is iced-up after a De-icing Cycle	<ul style="list-style-type: none"> • The door was closed • Evaporator temperature at end of De-icing Cycle too low • Maximum time of De-icing Cycle too short 	<ul style="list-style-type: none"> • Open the door when following the de-icing procedure • Increase the setting of Step 8 in Programming Section • Increase the setting of Step 7 in Programming Section
Too much water on evaporator fins	<ul style="list-style-type: none"> • The unit has been shut down without a De-icing Cycle 	<ul style="list-style-type: none"> • Start a De-icing Cycle
Slow to decrease in temperature (decline in performance)	<ul style="list-style-type: none"> • Temperature of room too high • Back of unit too close to the wall 	<ul style="list-style-type: none"> • Ventilate the room • Change the location of the unit
Slow to decrease in temperature (decline in performance)	<ul style="list-style-type: none"> • Condenser obstructed by dirt • Evaporator iced up 	<ul style="list-style-type: none"> • Clean the condenser • Perform a De-icing Cycle
Display temperature does not match the actual inlet air temperature (No alarm)	<ul style="list-style-type: none"> • In Probe Mode, the display shows the product temperature 	<ul style="list-style-type: none"> • Normal
All indicator lights off and ON/OFF switch will not operate	<ul style="list-style-type: none"> • Check electrical supply • Fuse of control board blown 	<ul style="list-style-type: none"> • Plug unit into receptacle, or reset wall circuit breaker • Change the fuse

4-2. ALARM MESSAGES

In the event of a system failure, the digital display will show an alarm message. These messages are coded; “AL-1”, “AL-2”, “AL-3”, “AL-5”, and “AL-6.” When an alarm occurs, the red alarm LED will illuminate and a buzzer (optional) will sound. Press the Alarm button to stop the buzzer.

NOTICE

The unit can operate on auto back-up if an alarm sounds for a faulty probe. Must select the Timer Mode, and enter a time.

Display	Cause	Correction
“AL-1”	Faulty air temperature probe	Replace the probe; unit can operate on auto back-up until a new probe is installed
“AL-2”	Faulty evaporator probe	Replace the probe; the De-icing Cycle can operate at 50% of the setting in step 7 of the Programming Section
“AL-3”	Faulty Frigiprobe	Replace the probe; the Frigiprobe Mode will not operate, but the unit will operate in the Timer Mode
“AL-5”	Temperature too low in the Hold Mode	Faulty control board - replace control board; faulty contactor - replace contactor
“AL-6”	Temperature too high in the Hold Mode	Faulty control board - replace control board; door opened too much - make sure door stays closed as much as possible

GLOSSARY

Refrigerated Equipment

air temperature probe	a temperature sensing device that controls the temperature after the Chilling Cycle has been completed
ballast	a device located on a fluorescent lamp fixture that helps the lamp power up quickly
chilling	the feature that cools products to a safe temperature
compressor	the unit that pumps the refrigerant through the system
condenser	a part of the system that changes the refrigerant to a liquid
cycle	an operational process such as chilling, freezing, hold, timer
defrosting / de-icing	the feature that prevents ice build up inside the unit
evaporator	a part of the system that changes the refrigerant to a gas
evaporator probe	a temperature sensing device that stops the de-icing cycle when completed
freezing	the feature that quickly freezes product
Frigiprobe	a temperature sensing device that is inserted into the product
hold	the feature that maintains the product at a safe temperature
LED	a light which illuminates to indicate the cycle or mode is in use
mode	a programming segment used to set up the various cycles, such as chilling, freezing, hold, timer, Frigiprobe
product	a food item chilled or frozen in the unit
refrigerant	a chemical coolant used by the refrigeration system
setpoint	a preset chilling or freezing temperature; the setpoint is a programmable feature
technical mode	used to program the unit's feature
timer	the feature that chills and freezes on a timed basis rather than using the Frigiprobe



Henny Penny Corporation
P.O.Box 60
Eaton, OH 45320

1-937-456-8400
1-937-456-8402 Fax

Toll free in USA
1-800-417-8417
1-800-417-8434 Fax

www.hennypenny.com

* FM05 - 026 - F * Henny Penny Corp., Eaton, Ohio 45320, Revised 09-27-07