

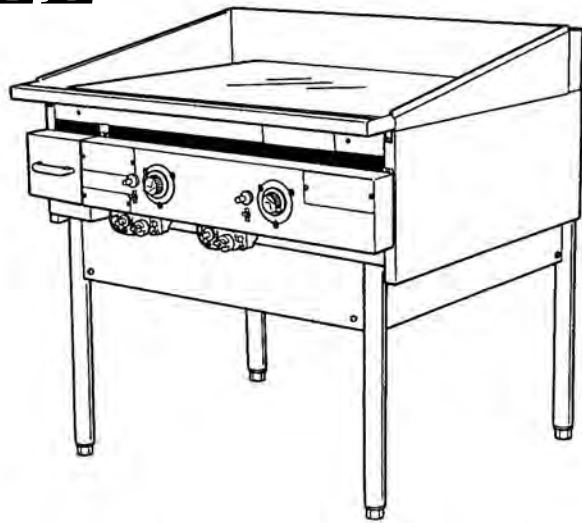

"Serving Those Who Serve The Very Best"

MIRACLEAN[®] GAS GRIDDLE SERVICE MANUAL



KEEP THIS MANUAL FOR TRAINING NEW PERSONNEL

1-800-KEATING
www.keatingofchicago.com

TABLE OF CONTENTS

SECTION I INTRODUCTION

Safety Precautions1-2

SECTION II INSTALLATION

Installation2
Damage During Shipment2
Positioning2
Leveling3
Restraining Devices3
Gas Connection3
Gas Leak Testing3-4

SECTION III OPERATING

Lighting4
Conditioning4-5
Cooking5
Griddle Surface5-6
Cleaning6
Shutdown6

SECTION IV MAINTENANCE

Warranty Repairs6
Preventive Maintenance6
Cleaning7
Limited Calibration7

SECTION V SERVICE DIAGNOSIS

Trouble Shooting Chart8

SECTION VI PARTS LIST

Ordering Parts8
Warning and Operating Plates8
Miraclean® Gas Griddle Assembly8
Control Panel Assembly9
Heating Element Assembly9

SECTION VII WIRING DIAGRAM

Gas Griddle Wiring Diagram10
WarrantyBack Inside Cover Page
Warranty CardInsert

**POST THIS LABEL IN A
PROMINENT LOCATION ON
YOUR UNIT.**

IMPORTANT

**IN THE EVENT A GAS ODOR IS DETECTED, SHUT
DOWN UNITS AT MAIN SHUT OFF VALVE AND
CONTACT THE LOCAL GAS COMPANY OR GAS
SUPPLIER FOR SERVICE.**



⚠ WARNING

**Do not store flammable
substances near this
appliance.**



FOR YOUR SAFETY

**DO NOT STORE OR USE GASOLINE OR OTHER FLAMMABLE
VAPORS OR LIQUIDS IN THE VICINITY OF THIS OR ANY OTHER
APPLIANCE.**

⚠ WARNING

**IMPROPER INSTALLATION, ADJUSTMENT, ALTERATION, SERVICE OR
MAINTENANCE CAN CAUSE PROPERTY DAMAGE, INJURY OR DEATH. READ THE
INSTALLATION, OPERATING AND MAINTENANCE INSTRUCTIONS THOROUGHLY
BEFORE INSTALLING OR SERVICING THIS EQUIPMENT.**



⚠ WARNING
Gas Burns Shock

**Improper installation
can cause damage,
injury or death.**

NOTE: As continuous product improvement occurs, specifications may be changed without notice.

I INTRODUCTION

MODEL VARIATIONS

Standard Griddles: Keating MIRACLEAN gas griddles are available in sizes ranging from 27" to 72" and in depths 24", 30", 33" and 36". The gas griddles are AGA, CSA, and NSF design certified.

SAFETY PRECAUTIONS



WARNING

THIS SYMBOL WARNS YOU THAT SERIOUS BURNS OR OTHER INJURIES MAY RESULT IF SAFETY INSTRUCTIONS ARE NOT FOLLOWED.

- This service manual should be retained in a safe place for future reference. The installation of your new griddle must conform to local codes or in the absence of local codes, with the current National Fuel Gas Code ANSI Z223.1 NFPA 54 (latest edition), Natural Gas Installation Code CAN/CGA-B149.1 or Propane Installation Code CAN/CGA-B149.2.
- Your ventilation hood, when installed, must conform to the current ANSI/NFPA 96 (latest edition).
- No frame or restriction shall be constructed around the lower part of the MIRACLEAN® that would restrict air movement into a MIRACLEAN® combustion area or prevent proper ventilation.
- Keating gas griddles are designed to operate on the gas fuel specified on the serial plate and must not be operated with another gas fuel. They cannot be converted to another gas fuel by turning or engaging a switch.
- Your Keating MIRACLEAN® gas griddle is designed to use only the type of gas indicated on the serial plate attached to the front of the MIRACLEAN®.



FOR YOUR SAFETY: Do not store or use gasoline or other flammable vapors and liquids in the vicinity of this or any appliance.

You will post, in a prominent location, instructions to be followed in the event the user smells gas. This information shall be obtained from your local gas supplier. You may use the yellow stick-on label temporarily until you receive the data from your local gas supplier.

IMPORTANT: In the event a gas odor is detected, shut down unit at main shut-off valve and contact the local gas company or gas supplier for emergency service.

- You must maintain this appliance free and clear from combustibles.
- You must maintain the following minimum clearances for combustible and noncombustible construction:

<u>Clearances</u>	<u>Combustible Construction</u>	<u>Noncombustible Construction</u>
Back	6"	0"
Right Side	6"	0"
Left Side	6"	0"

- You must install this appliance at least 16 inches away from any open flame.
- Adequate clearance for servicing and proper operation must be maintained. Your Keating MIRACLEAN® is designed to be serviced from the front.
- Keating commercial griddles are intended for other than household use.
- ALWAYS instruct new employees on proper griddle operation.
- A MIRACLEAN® griddle should be operated ONLY by properly trained personnel.
- ALWAYS turn griddle off each night.
- ALWAYS disconnect fuel source before servicing.
- NEVER leave a griddle unattended during operation.
- NEVER move griddle when hot.

THIS GRIDDLE MAY NOT BE ALTERED, MODIFIED OR CHANGED IN ANY WAY.

The State of California enacted the California Safe drinking water and Toxic Enforcement Act of 1986, (Prop. 65), which "prohibits any person in the course of doing business from knowingly and intentionally exposing any individual to a chemical known to the State of California to cause cancer or reproductive toxicity without first giving clear and reasonable warning to such individuals." The Governor's Scientific Advisory Panel added carbon monoxide to the list of hazardous chemicals known to cause reproductive harm.

In order to establish full compliance with Proposition 65, we attached a yellow warning label to each gas fired griddle that Keating of Chicago, Inc. manufactures. Carbon monoxide would not be present in concentrations that would pose a "significant risk" to the consumer when the equipment is installed,

operated and maintained as follows:

- Installed in accordance with all local codes, or in the absence of local codes, with the current National Fuel Gas Code Z223.1 (latest edition), National Gas Installation CAN/CGA-B149.1, or the Propane Installation Code, CAN/CGA-B149.2.
- Installed under a properly designed and operating exhaust hood.
- Connected to the type of gas for which the griddle is manufactured.
- Pressure regulator is installed in the appliance and adjusted for the manifold pressure marked on the serial plate.
- Adequate air supply to the unit.
- In-line pressure regulator, not supplied by Keating, must be installed outside the appliance.
- The equipment is operated in the manner intended using the proper utensils.
- Keep the equipment clean and have it checked periodically.
- Burner air adjustments, mechanical maintenance and repairs must be performed by qualified service personnel.

If the equipment is not installed, operated and maintained in accordance with the above, concentrations of carbon monoxide in excess of the established limits could be present in the kitchen environment.

ALL PERSONNEL IN THE WORK PLACE WHO MAY BE SUBJECT TO ANY EXPOSURE OF CARBON MONOXIDE MUST BE WARNED OF SUCH POSSIBLE EXPOSURE. THIS WARNING SHOULD BE CONVEYED IN A MANNER SO THAT IT IS CLEARLY UNDERSTOOD BY THE EMPLOYEE, AND THE EMPLOYEE SHOULD BE ASKED IF IN FACT HE OR SHE UNDERSTANDS THE CORRECT METHOD OF OPERATION OF THE EQUIPMENT AND THAT A RISK OF EXPOSURE EXISTS IF THE EQUIPMENT IS OPERATED IMPROPERLY.



WARNING

IF NOT INSTALLED, OPERATED AND MAINTAINED IN ACCORDANCE WITH THE MANUFACTURER'S INSTRUCTIONS, THIS PRODUCT COULD EXPOSE YOU TO SUBSTANCES IN FUEL OR IN FUEL COMBUSTION WHICH CAN CAUSE DEATH OR SERIOUS ILLNESS AND WHICH ARE KNOWN TO THE STATE OF CALIFORNIA TO CAUSE CANCER, BIRTH DEFECTS OR OTHER REPRODUCTIVE HARM.

II INSTALLATION

This UNIT must be installed, inspected, calibrated and serviced by qualified and/or certified and licensed service personnel - you may void your Keating warranty if installation is not completed per local, national and Keating specifications. Contact your dealer for assistance.

INSTALLATION

Installation must conform with local codes or, in absence of local codes, with current National Fuel Gas Code ANSI Z223.1 (latest edition), Natural Gas Installation Code CAN/CGA-B149.1 or Propane Installation Code CAN/CGA-B149.2.

NOTE: NOT FOR OUTDOOR INSTALLATION

DAMAGE DURING SHIPMENT

The griddle has been assembled, tested and inspected at the factory. Upon arrival, the complete griddle should be checked for any damage that may have occurred during shipment.

The carrier is responsible for all damage in transit whether visible or concealed. Do not pay the freight bill until the griddle has been thoroughly checked for damage. If concealed damage is found later, contact the carrier immediately to file a claim.

What to do if equipment arrives damaged:

VISIBLE LOSS OR DAMAGE – Be certain to note this on the freight or express receipt and have it signed by the delivery person.

FILE CLAIM FOR DAMAGES IMMEDIATELY – Regardless of extent of damage.

CONCEALED LOSS OR DAMAGE – If damage is noticed when equipment is unpacked, notify the freight company immediately, and file a “concealed damage claim”. This **MUST** be done immediately. Be sure to retain the shipping container for inspection.

Keating does not assume responsibility for Loss or Damage incurred in transit.

POSITIONING

The griddle must be no closer than six inches (6") from any combustible material. The griddle must be placed under an exhaust hood with a fire retardant system. Your ventilation hood, when installed, must conform to ANSI/NFPA 96 (latest edition). ALL connections and placement must comply with local and national codes. It is the responsibility of the owner and local installer to comply with these regulations when installing the griddle.

LEVELING

The griddle will operate at its highest efficiency when properly leveled. Place a level on the griddle plate from side to side. For griddles on legs, the bottom foot of the leg is adjustable. Turn counterclockwise to decrease height or clockwise to increase height until level. For griddles on stands with casters, the casters are adjustable by loosening the jam nut and turning the caster in or out. When the desired level is reached, tighten the jam nut. Adjustments of more than 3/4" are not recommended on any caster. The same procedure should be followed to level the griddle from front to back.

Figure 2-1

Leveling Griddle

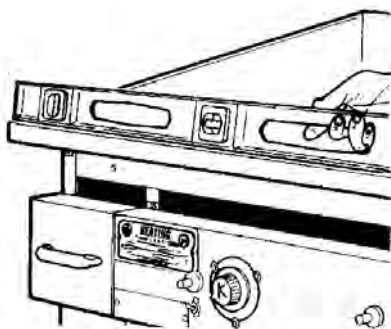

RESTRAINING DEVICES



On griddle installation on stands with casters, jam nuts must be completely tightened. Adequate means must also be provided to limit the movement of the appliance without depending on the connector, the quick-disconnect device or its associated piping to limit the appliance movement.

Connectors must comply with the current ANSI Z21.69/CAN 1 CAN/CGA 6.16 (latest edition) standard for connectors for movable gas appliances. Quick-disconnect devices must comply with the ANSI Z21.41/CAN 1 6.9 (latest edition) standard for quick-disconnect devices for use with gas fuel as applicable.

IF DISCONNECTION OF THE RESTRAINT IS NECESSARY, IT MUST BE RECONNECTED WHEN THE MIRACLEAN® GRIDDLE IS RETURNED TO ITS ORIGINALLY INSTALLED POSITION.

GAS CONNECTION



■ **PIPE JOINT COMPOUNDS RESISTANT TO PROPANE GASES MUST BE USED.**

■ **BEFORE OPERATING THIS GRIDDLE, CHECK PIPE JOINTS FOR LEAKS BY USING A SOAP AND WATER SOLUTION ONLY. DO NOT USE AN OPEN FLAME!**

■ **DO NOT SHORT GAS VALVE TERMINALS WHEN TESTING WIRING, AS THERMOSTAT AND GAS VALVE DAMAGE MAY OCCUR AND CAUSE UNSAFE CONDITIONS.**

You will post, in a prominent location, instructions to be followed in the event the user smells gas. This information shall be obtained from your local gas supplier. You may use the yellow stick-on label enclosed on page "ii" temporarily until you receive the data from your local gas supplier.

Connect the griddle to the main gas supply line at the rear of the griddle. The piping should be a minimum of 3/4" IPS supply pipe for a single griddle at the burner manifold. Installation must conform to the current local and NATIONAL FUEL GAS CODE ANSI Z223.1 / NFPA 54 (latest edition), Natural Gas Installation Code CAN/CGA-B149.1 or Propane Installation Code CAN/CGA-B149.2 (latest edition).

A 3/4" NPT manual gas valve is shipped with each griddle for field installation. The required gas pressure for proper operation of each griddle is 4" water column for natural gas and 10" water column for Propane gas at the burner manifold.

NOTE: If more than one gas unit is on the same supply line, you may require a larger line. Consult your local gas company to assure adequate volume and pressure. Refer to serial plate for proper gas requirements for your particular model.

GAS LEAK TESTING

1. Make sure all thermostats, switches and safety valves are in the "OFF" position.

Figure 2-2
Thermostat

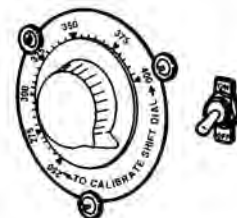

2. Close main and pilot gas supply by partially depressing and turning ON/OFF knob to the "OFF" position.

Figure 2-3

Millivolt Safety Pilot Valve

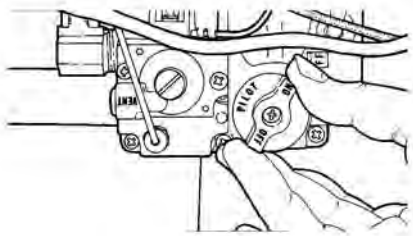

3. Turn main ON/OFF supply line gas valve to the "ON" position.
4. Have your plumber or gas company representative check for leaks with a soap solution. **(Never check with a match!)**



WARNING

PROPANE GAS MAY EVENTUALLY LOSE ITS ODOR AND PRECAUTIONS SHOULD BE TAKEN TO ASSURE THAT PROPANE GAS IS NOT PRESENT EVEN THOUGH YOU DO NOT DETECT AN ODOR. IF THERE IS ANY DOUBT, YOU SHOULD CALL YOUR LOCAL PROPANE GAS SUPPLIER FOR ASSISTANCE.

III OPERATING

LIGHTING

Lighting instructions are also listed on the lighting instruction plate attached to the front of the air shield.

1. Turn the ON/OFF switch to the "OFF" position.
2. Turn gas valve knob to pilot position.

Figure 3-1

Millivolt Safety Pilot Valve

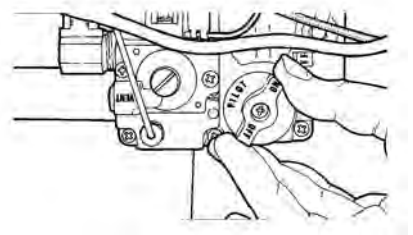

3. Depress and hold gas valve knob while repeatedly pushing red button (Piezo spark ignitor) on control

panel until pilot flame is established. Allow pilot to burn 90 seconds before releasing gas valve knob. This will allow the thermopile to reach its maximum millivolt and milliamp output.

NOTE: Allow pilot to burn one additional minute before turning thermostat dial to desired position. Pilot flame should be blue in color and high enough to envelop the tip of the thermopile to activate the gas safety valve.

Figure 3-2

Piezo Spark Ignitor

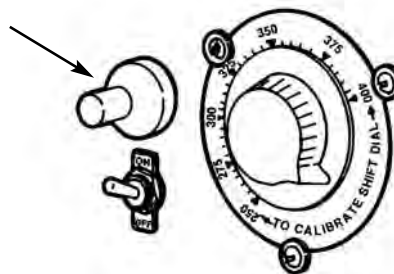

4. Turn gas valve knob to "ON" position.
5. Turn ON/OFF switch to "ON" position.
6. Set thermostat dial to desired temperature. When the griddle plate reaches the temperature setting the main burners will extinguish.



DURING INITIAL INSTALLATION, AFTER OVERNIGHT SHUTDOWN, OR WHEN RELIGHTING, AIR IN THE SUPPLY LINE MAY MAKE IT NECESSARY TO HOLD THE GAS VALVE IN THE DEPRESSED PILOT POSITION FOR A LONGER THAN NORMAL PERIOD OF TIME. WAIT FIVE MINUTES BEFORE REPEATING

LIGHTING PROCEDURE TO ALLOW ANY GAS WHICH MAY HAVE ACCUMULATED IN THE BURNER COMPARTMENT TO ESCAPE.

NOTE: If you have difficulty lighting the pilot:

1. Place ON/OFF switch to the "OFF" position.
2. Wait five minutes before relighting.
3. Repeat Steps 2 - 6 of Lighting Instructions.

CONDITIONING THE GRIDDLE

The MIRACLEAN® Griddle plate has been "seasoned" at the factory. The chrome surface, when heated creates a thin layer of chrome oxide which acts as a releasing agent for food product. If you feel you need to recondition, the following instruction should be followed:

1. Follow cleaning instruction on page 7.
2. Heat the MIRACLEAN® to 400°F for one hour.
3. Lower thermostat to 350°F, allowing the MIRACLEAN® to cool to about 350°F, as is evident when griddle cycles on or surface thermometer indicates correct temperature.
4. Lightly coat the MIRACLEAN® surface with shortening.

COOKING

MIRACLEAN® Griddles are designed to provide maximum production efficiency and deliver high quality food products. Follow cooking procedures below for your model.

1. Set the thermostat to the desired temperature and wait ten minutes for preheat. Shown are recommended cooking temperature guides:

RECOMMENDED COOKING TEMPERATURES	
PRODUCT	(°F)
Eggs	250
Bacon	325
Sausage (patty or link)	325
Hash browns	350
French Toast	350
Wheat Cakes	360
Hamburgers- 2 / lb. (8 oz.)	325
4 / lb. (4 oz.)	315
10 / lb. (1.6 oz.)	310
Grilled Cheese	325
Chicken Breasts (skinless)	350
Hot Dogs- 10 / lb. (1.6 oz.)	310
8 / lb. (2 oz.)	310
Salmon Filet	325
Salmon Steaks	325
Buns/Breads (toasting) 30 seconds max.	375

NOTE: Because of the superior heating characteristics and heat retention properties found in the MIRACLEAN® Griddle, operating temperatures should be set 10°F to 25°F below conventional griddles.

2. Cook as usual, but after each batch scrape the griddle in the work area, completely clean, using the Keating replaceable blade scraper.
3. Locate the inverted “V’s” on the front of the griddle cooking plate. Depending on your model you may have from one to five thermostats. The “V’s” indicate where the thermostat sensing bulbs are located below the plate. See Figure 3-3.

4. Load the product to the left and right of each inverted “V” first, then fill the area above the thermostat sensing bulb. See figure 3-3.

Figure 3-3

Sample configuration of proper food placement

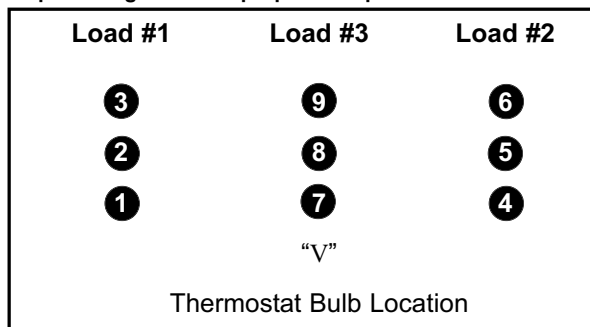

If you cook over the sensing bulb only, you are drawing heat from that section, thus activating the thermostat to call for more heat even though the area around it is still at the temperature setting. This will result in higher surface temperatures which will affect your cooking and possibly product appearance.

GRIDDLE SURFACE

With proper care, the MIRACLEAN® surface and its unique cooking properties will last for many years. However, nicks or dents in the griddle surface may cause the griddle surface to lift from the depressed area. If nicks are close together, the surface may raise and be torn when a spatula or scraper is used. Care should be taken, as the damage done is irreparable.



CAUTION: DO NOT HACK, CHOP, HIT OR CUT ON THE MIRACLEAN® SURFACE. YOU WILL DENT THE STEEL PLATE UNDER THE TRIVALENT CHROME. IT IS EVEN POSSIBLE TO HACK TWO NICKS CLOSE TOGETHER AND ACTUALLY TEAR THE MIRACLEAN® SURFACE AS THE CHROMIUM WILL NOT STRETCH. BELOW IS A SKETCH SHOWING THE SIDE VIEW OF A GRIDDLE PLATE AND HOW THE SURFACE CAN BE DAMAGED. PROPER USE OF THE UTENSILS SUPPLIED WITH YOUR MIRACLEAN® GRIDDLE WILL PREVENT SURFACE DAMAGE.

Figure 3-4

Surface Damage

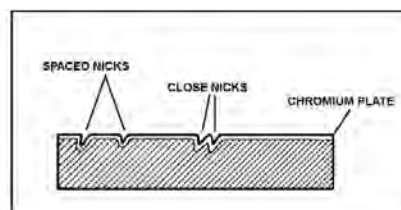

NOTE: Damage done to the MIRACLEAN® surface is irreparable.

CLEANING THE GRIDDLE

The surface of the MIRACLEAN® Griddle is very durable and with proper care, following the procedures below, will last many years.

A sample of Keating Klenzer, Keating palmetto brush and a 4" scraper are included with each new griddle.

1. Scrape MIRACLEAN® surface.

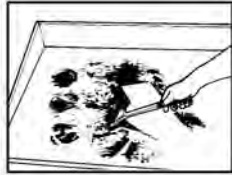

2. Clean with potable tap water and a Keating palmetto brush.

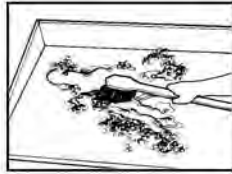

3. Polish surface with Keating Klenzer and a soft cloth (towel). Rinse with potable water to remove excess Keating Klenzer.

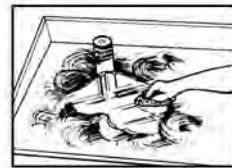

CLEANING UTENSILS

Spatulas should be hand washed in mild to medium strength detergent and towel dried.

NOTE: Avoid contact with Chlorine or bleach, it will discolor steel spatula. Rubbing the spatula with vegetable oil will slow discoloration.

Rinse **scraper** and carefully wipe blade with a dry cloth. Cover blade with plastic protection cover when not in use.

Rinse Palmetto brush until clean.

SPATULA



SCRAPER



WARNING

BECAUSE OF THE SUPERIOR MIRACLEAN® SURFACE, THE ONLY TOOLS YOU WILL EVER NEED TO CLEAN THE GRIDDLE ARE A NATURAL BRISTLE BRUSH AND A KEATING SCRAPER.

- NEVER USE GRIDDLE STONES, GRIDDLE BRICKS, GRIDDLE SCREEN OR HARSH CHEMICALS TO CLEAN THE MIRACLEAN® SURFACE.

- DAMAGE DONE TO THE MIRACLEAN® SURFACE BY GRIDDLE STONE, GRIDDLE BRICK, GRIDDLE SCREEN OR HARSH CHEMICALS WILL VOID THE WARRANTY.

- THE DAMAGE DONE TO THE MIRACLEAN® SURFACE IS IRREPARABLE.

- NEVER USE ICE TO COOL THE MIRACLEAN® SURFACE. USE OF ICE MAY WARP THE MIRACLEAN® SURFACE.

- USE ONLY KEATING SUPPLIED CLEANING TOOLS AND KLENZER.

- USE ONLY A KEATING STEEL SPATULA.

- DO NOT CLEAN SCRAPER ON SPLASHBACK, GREASE BUILD-UP WILL OCCUR WHICH MAY RESULT IN A FIRE.

- DO NOT WASH STEEL SPATULA WITH CHLORINE OR BLEACH AS IT WILL DISCOLOR.

- DO NOT STORE ANYTHING IN OR ON THE FLUE OF THE MIRACLEAN®.

SHUTDOWN

1. Turn ON/OFF switch to "OFF" position.
2. Turn gas valve knob to "OFF" position.
3. Rotate thermostat knob to left to "OFF" position.
4. Check to determine that all burners, including pilot light, are extinguished.
5. If you must restart your MIRACLEAN®, wait five minutes before restarting or relighting with piezo spark ignitor or a match.

IV MAINTENANCE

WARRANTY REPAIRS

Keating's warranty begins with the date of installation. In the event that your MIRACLEAN® Griddle, under warranty, needs repairs other than routine maintenance or cleaning, you are requested to contact your local service distributor.

PREVENTIVE MAINTENANCE

Preventive maintenance should be done in daily, weekly, monthly and yearly intervals as necessary. Following preventive maintenance procedures will help keep your MIRACLEAN® working efficiently. Proper care and servicing will lead to years of quality performance.

PREVENTIVE MAINTENANCE CHART

TIME FRAME	OPERATOR/OWNER	SECTION
Daily	<ul style="list-style-type: none"> • Clean griddle surface. • Drain and clean grease drawer. • Completely wipe down griddle cabinet. 	III
Monthly*	<ul style="list-style-type: none"> • Check MIRACLEAN® surface to insure proper maintenance. (Review proper cooking procedures) • Check calibration of thermostat(s). • Review operating instructions received with griddle. 	III IV II
Yearly*	<p>QUALIFIED SERVICE PERSONNEL ONLY</p> <ul style="list-style-type: none"> • Have griddle completely checked, calibrated, tested, cleaned, etc. by qualified service personnel. Be sure to check color and height of pilot flame. 	

*High production facilities should be checked more often.

CLEANING

Proper care should be taken to fully clean the griddle on a regular basis.

A. CONTROL PANEL – Clean any grease build-up on switches and thermostat knobs.

IF ELECTRONIC IGNITION MODEL:

DISCONNECT ELECTRIC POWER SOURCE BEFORE CLEANING. (REFER TO ELECTRONIC IGNITION MANUAL)

NOTE: If grease gets into the working mechanism of a switch or thermostat, it may cause the unit to fail.

B. CABINET - The front, back and sides of the cabinet should be kept clean for sanitary reasons.

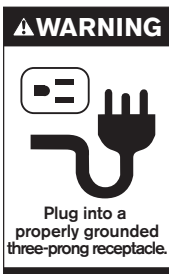

GREASE BUILD-UP NEAR ANY OPEN FLAME IS A FIRE HAZARD.

C. FLUE - The flue has been designed specifically to exhaust the by-product of any combustion. Any objects (steak weights, egg covers, pans, rags, utensils, etc.) placed on the flue will inhibit the proper combustion and exhaust, therefore causing health hazards.

LIMITED CALIBRATION

NOTE: Calibration is not covered under warranty.

Tools: Accurate surface thermometer

Standard screwdriver

Calibrating screwdriver

1. Turn the exhaust system ON.
2. Turn on the griddle with thermostat set at 300°F. Turn switches to ON position to allow burners to cycle on and off **three** times. (Approximately 60 minutes.)
3. Place thermometer on surface over thermostat bulb. Use the inverted "V" to locate thermostat bulb. See Figure 3-3. When you have located the inverted "V", the thermostat bulb is approximately 2/3 to 3/4 of the way straight back to the rear of the griddle.
4. When burners cycle off, griddle is up to temperature. If temperature is within 25°F of thermostat setting, loosen the four retaining screws on the dial plate. Rotate the dial plate. Indicating arrow on the thermostat knob should point to the temperature indicated on the thermometer.

Piezo Spark Ignitor

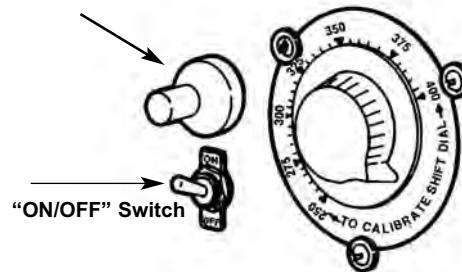

5. Tighten screws.

For calibration over a 25°F difference, contact your local service agent.

V SERVICE DIAGNOSIS

The following diagnosis is only to be used as a guide to qualified service personnel. Keating recommends that you use a qualified service company. (Equipment still under warranty requires it.)

NOTE: To correctly and quickly diagnose the system, the following chart should be followed in sequential order.

TROUBLE SHOOTING CHART

PROBLEM	PROBABLE CAUSE	SOLUTION
No pilot	a. Gas supply not "ON". b. Air in gas lines. c. Quick disconnect not tight. d. Gas valve is in "OFF" position. e. Faulty Piezo Ignitor.	a. Open gas supply valve. b. Press gas valve knob in "pilot" position and hold. c. Tighten quick disconnect. d. Turn valve knob to "pilot". e. Replace ignitor.
Pilot won't stay on	a. Loose thermopile. b. Faulty thermopile.	a. Tighten fitting and/or terminal leads. b. Replace thermopile.
Pilot on but no main burner ignition	a. ON/OFF switch is in "OFF" position. b. Gas valve is in "pilot" position. c. Thermostat is not on. d. Thermostat failure. e. Gas valve failure.	a. Put ON/OFF switch to "ON" position. b. Turn knob to "ON" position. c. Turn thermostat to desired temperature. d. Replace thermostat. e. Replace valve.
Temperature of griddle erratic	a. Thermostat is not calibrated. b. Air from exhaust hood excessive. c. Improper cooking procedure.	a. Calibrate thermostat. b. Have exhaust hood inspected. c. See 'Cooking', page 5.
Griddle stays hot or overheats	a. Thermostat is not calibrated. b. Thermostat failure. c. Gas valve faulty. d. Improper cooking procedure.	a. Calibrate thermostat. b. Replace thermostat. c. Replace gas valve. d. See 'Cooking', page 5.

VI PARTS LIST

ORDERING PARTS

Parts may be ordered by part number by calling Keating at 1-800-KEATING or your service company. You may also order on-line at Keating's part store, www.keatingofchicago.com

Refer to the Keating MIRACLEAN® Griddle Limited Warranty for complete service and ordering information.

The model/serial plate is located on the front of the control panel. The serial and model numbers are necessary information when ordering.

WARNING AND OPERATING PLATES

All warning and operating plates on the Keating MIRACLEAN® Griddle should be in place at all times. If plates are damaged or lost, replace them immediately.

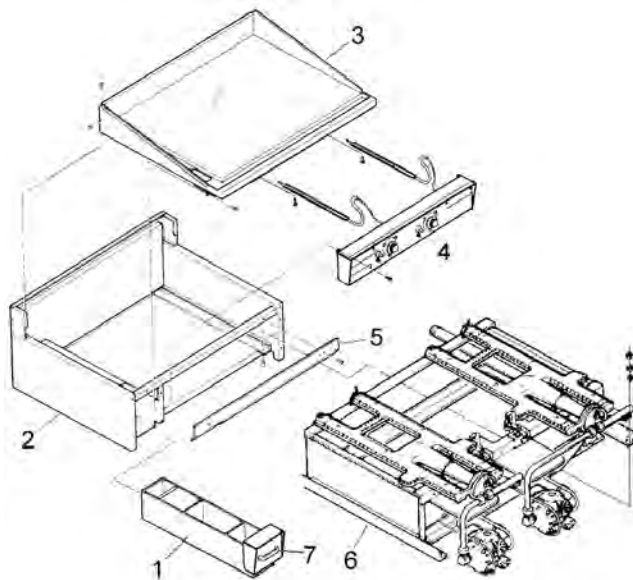

Figure 6-1 MIRACLEAN Griddle Assembly

ITEM	DESCRIPTION	PART NUMBER
1	GREASE DRAWER ASSEMBLY 24" DEEP GRIDDLES	004013
	30", 33", AND 36" DEEP GRIDDLES	002446
2	CABINET	REFERENCE ONLY
3	PLATE AND PERIMETER	CALL 1-800-KEATING
4	CONTROL PANEL ASSEMBLY	SEE PAGE 9
5	HEAT SHIELD	CALL 1-800-KEATING
6	BURNER INSERT	SEE PAGE 9
7	GREASE DRAWER HANDLE	004542

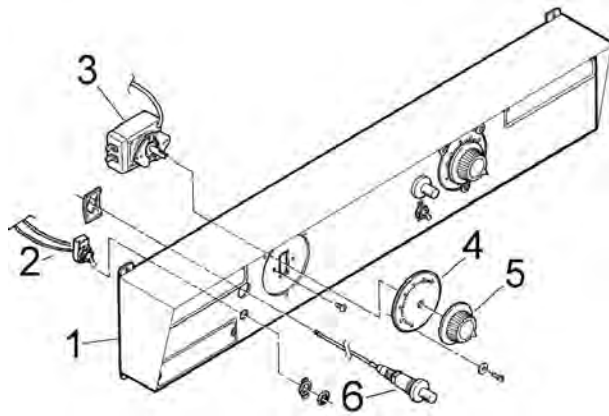

Figure 6-2 Control Panel Assembly

ITEM	DESCRIPTION	PART NUMBER
1	CONTROL PANEL	CALL 1-800-KEATING
2	THERMOSTAT "ON/OFF" SWITCH WITH WIRES	009345
3	THERMOSTAT 250°-400°F	017370
	THERMOSTAT 150°-550°F	023897
	THERMOSTAT REPLACEMENT KIT FOR 400°F +- STAT	037088
4	THERMOSTAT DIAL PLATE 250°-400°F	034870
	THERMOSTAT DIAL PLATE 200°-500°F	060105

- 5 THERMOSTAT KNOB 400° 060612
- THERMOSTAT KNOB 550° 038368
- 6 PIEZO SPARK IGNITOR ASSEMBLY
 - A. MOUNTED ON LEFT, 45° BRACKET. USED ON ALL NATURAL GAS STANDARD GRIDDLES AS WELL AS 27" AND 30" LEFT SIDE ON SINGLE BURNER PROPANE GRIDDLES. 010946
 - B. MOUNTED ON RIGHT. 45° BRACKET. USED ON BEF 36" & 27: AND 30" RIGHT SIDE GRIDDLES. 002556
 - C. CENTER MOUNT. 90° BRACKET. USED ON ALL PROPANE GRIDDLES WITH MORE THAN TWO BURNERS (42"AND UP). FOR BAT WING PILOT. 010365
 - D. NO MOUNTING BRACKET. USED ON PROPANE GRIDDLES with 2 or less burners 24", 27", 30", 36" ON RIGHT SIDE. 008327
 - E. NO MOUNTING BRACKET. MOUNTS ON PILOT BRACKET 010364

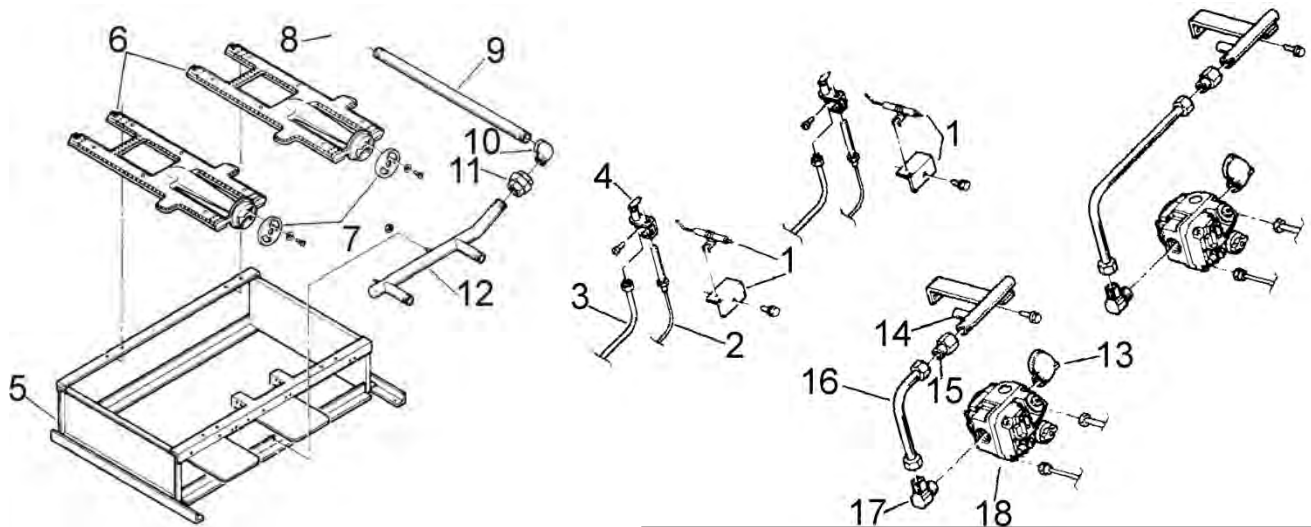

Figure 6-3 Natural and Propane Gas Heating Systems

ITEM	DESCRIPTION	PART NUMBER
1	SPARK IGNITION ASSEMBLY	
	SEE Item 6, Figure 6-2	
2	THERMOPILE	022770
3	PILOT TUBE (1/4")	007998
4	PILOT ASSEMBLY	029769 & 029599
	(ALL NATURAL GAS, 24"-30" LP, 24"-39" BEF)	
	NATURAL GAS ORIFICE	007696
	PROPANE ORIFICE	007766
5	BURNER INSERT	REFERENCE ONLY
6	BURNER	REFERENCE ONLY
7	AIR SHUTTERS	031477

- 8 MAIN SUPPLY GAS VALVE 3/4" 019515
- (not shown above)
- 9 MAIN GAS PIPE (3/4") REFERENCE ONLY
- 10 STREET ELBOW (3/4") 005738
- 11 UNION 002658
- 12 MANIFOLD 1-800-KEATING
- 13 STREET ELBOW (1/2") 004194
- 14 ORIFICE HOLDER ASSEMBLY REFERENCE ONLY
- 15 FITTING (IF ELBOW) 006477
- FITTING (IF STRAIGHT) 006473
- 16 BURNER TUBE (1/2" x 9") 1-800-KEATING
- 17 ELBOW (1/2" x 3/8") 002462
- STRAIGHT 000615
- 18 GAS VALVE, MILLIVOLT
- NATURAL GAS 023625
- PROPANE GAS 023624

SECTION VII WIRING DIAGRAM

GAS GRIDDLE WIRING DIAGRAM

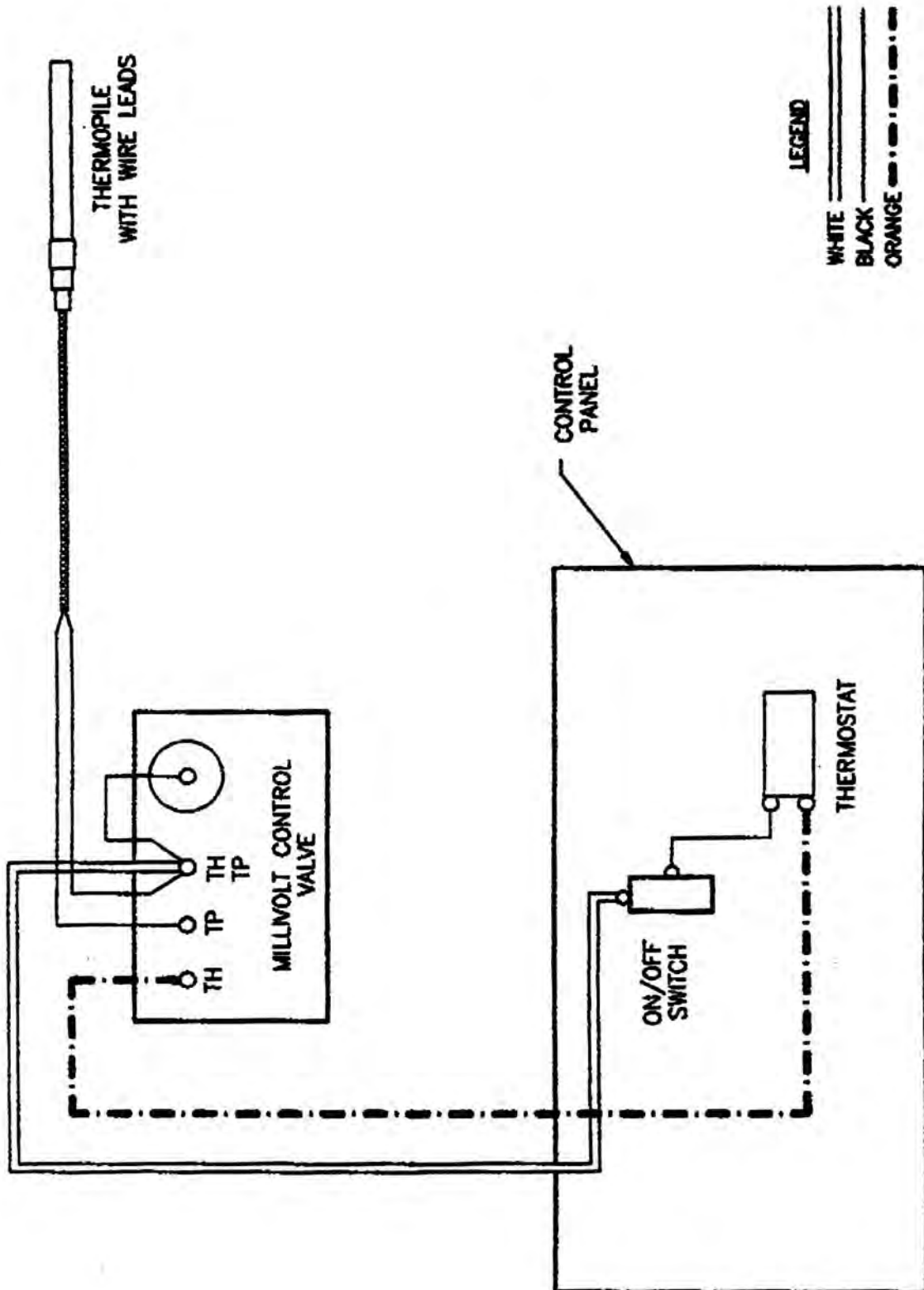



WARRANTY

LIMITED WARRANTY

Keating of Chicago, Inc. ("Keating") warrants to the original purchaser. ("Customer"), all new Keating Fryers, Filter Systems, Griddles, Keep Krisp®️, Custom Pasta Systems, Top-Side™ Cookers, Computer Timers, Fryer & Pasta Vessels and Keating replacement parts ("products") installed after June 1, 1994 to be free to defects in material or workmanship, subject to the following terms and conditions.

LENGTH OF WARRANTY

All products other than Fryer & Pasta Vessels and replacement parts shall be warranted for a period of one year from the date of original equipment installation. Keating replacement parts are warranted for a period of ninety days from the date of installation. Fryer & Pasta Vessels are warranted as described below.

FRYER & PASTA VESSEL WARRANTY

Fryers purchased after June 1, 1994 carry a prorated vessel warranty on defects in materials or workmanship to the Customer based on the following scale:

Time from Installation Date	Fryer Vessel Warranty Credit
13-60 months	100%
61-72 months	80%
73-84 months	60%
85-96 months	40%
97-108 months	20%
109-120 months	10%

The credit for the defective fryer & pasta vessel shall be applied against the cost of the replacement vessel, utilizing Keating's then current price, upon return of the vessel to Keating. (freight to be paid by Keating within the first 12 months only), only during the first 60 months, subject to the limitations described below.

LIMITATIONS OF LIABILITY

In the event of warranty claim or otherwise, the sole obligation of Keating shall be the repair and / or replacement at the option of Keating of the product or component or part thereof. Such repair or replacement shall be at the expense of Keating except that the Customer shall pay the following expenses: all freight and labor expense for Keating replacement parts; for all other products, mileage exceeding 50 miles or travel more than one hour, labor costs of more than one person, overtime rates, truck charges, difference between ground and other mode of transportation, and holiday charges. Any repair or replacement under this Limited Warranty does not constitute an extension of the original warranty for any period for the product or for any component or part thereof. Parts to be replaced under this Limited Warranty will be repaired at the option of Keating with new or functionally operative parts. Keep Krisps and Computer Timers must be returned to Keating for warranty repair or replacement. Field repairs of those items are not authorized.

THE LIABILITY OF KEATING ON ANY CLAIM OF ANY KIND, INCLUDING CLAIMS BASED ON WARRANTY, EXPRESSED OR IMPLIED, CONTRACT, NEGLIGENCE, STRICT LIABILITY OR ANY OTHER THEORIES SHALL BE SOLELY AND EXCLUSIVELY THE REPAIR OR REPLACEMENT OF THE PRODUCT AS STATED HEREIN, AND SUCH LIABILITY SHALL NOT INCLUDE, AND CUSTOMER SPECIFICALLY RENOUNCES ANY RIGHTS TO RECOVER, SPECIAL, INCIDENTAL, CONSEQUENTIAL OR OTHER INJURIES TO PERSONS OR DAMAGE TO PROPERTY, LOSS OF PROFITS OR ANTICIPATED PROFITS, OR LOSS OF USE OF THE PRODUCT.

If any oral statements have been made regarding the Keating products, such statements do not constitute warranties and are not part of the contract sale. This Limited Warranty constitutes the complete, final and exclusive statement with regard to warranties.

THIS LIMITED WARRANTY IS EXCLUSIVE AND IS IN LIEU OF ALL OTHER WARRANTIES WHETHER WRITTEN, ORAL, STATUTORY OR IMPLIED, INCLUDING BUT NOT LIMITED TO ANY WARRANTY OF MERCHANTABILITY OR FITNESS FOR PARTICULAR PURPOSE OR WARRANTY AGAINST LATENT DEFECTS.

EXCLUSIONS

The warranties provided by Keating of Chicago, Inc. do not apply in the following instances:

1. Defects arising out of or resulting from improper installation or maintenance, abuse, misuse, modification or alteration by unauthorized service personnel, or any other condition not attributable to a defect in material or workmanship. Proper installation and maintenance are the responsibility of the installer and Customer, respectively. Proper installation and maintenance procedures are prescribed by the Keating Service Manual.
2. In the event that the product was damaged after leaving the factory due to flood, fire, other acts of God or accident, damage during shipment should be reported to the carrier and is not the responsibility of Keating.
3. In the event the serial number or rating plate has been removed from the product or altered.
4. On parts which would normally be worn or replaced under normal conditions, including but not limited to electric bulbs, fuses, interior and exterior finishes, gaskets and radiants.
5. With regard to adjustments and calibrations such as leveling, tightening of fasteners or plumbing connections, improper gas pressure or improper electrical supply, the checking of and changes in adjustment and calibrations are the responsibility of the installer. Proper installation procedures are prescribed by the Keating Service Manual.
6. In the event of unauthorized repairs or alterations to the Keating product.
7. With the use of sodium chloride in pasta vessels or harsh chemicals in fryer or pasta vessels.
8. Installation in Household.

OTHER TERMS AND CONDITIONS

The Customer must provide proof of purchase from Keating.

This Limited Warranty is valid in the 50 United States, its territories, and Canada, and is void elsewhere.

Keating products are sold for commercial use only. If any Keating product is sold as a component of another product or used as a consumer product, such Keating product is sold As Is without any warranty.

If any provision of this Limited Warranty is held to be unenforceable under the law of any jurisdiction, such provision shall be inapplicable in such jurisdiction, and the remainder of the warranty shall remain unaffected. Further in such event, the maximum exclusion or limitation allowable under applicable law shall be deemed substituted for the unenforceable provision.

This Limited Warranty shall be governed by and construed in accordance with the laws of the State of Illinois.

TO SECURE WARRANTY SERVICE

All repair services under this Limited Warranty must be authorized by Keating or performed at Keating. Authorization may be obtained by calling 1-800-KEATING within the Continental United States, Alaska, Hawaii, Puerto Rico and Canada during normal business hours (8 a.m. through 5 p.m. Central Time, Monday through Friday). When calling, please have the following information available: (1) name, address and telephone number of the Customer; (2) location of product, if different; (3) name, model number and serial number of the product; (4) installation date; and (5) description of defect. Keating will then issue a service authorization work order number to one of its approved independent servicing organizations, or request the product or part be shipped to Keating for repair or replacement, as appropriate. Any defective part subject to a claim under this Limited Warranty must be shipped freight prepaid to Keating for testing and examination. Keating's decision as to the cause and nature of any defect under this Limited Warranty shall be final.

SERVICE INFORMATION

If you have a service related question call 1-800-KEATING.

Please state the nature of the call; it will ensure speaking with the appropriate person.

Have your serial and model number available when ordering parts.

KEATING OF CHICAGO, INC.

Phone: (708) 246-3000 FAX: (708) 246-3100

Toll Free 1-800-KEATING (In U.S. and Canada)

www.keatingofchicago.com

***As continuous product improvement occurs, specifications may be changed without notice.**

KEATING LIMITED WARRANTY CARD

PLEASE COMPLETE AND MAIL AT ONCE--WARRANTY IS NOT IN EFFECT UNTIL CARD IS RETURNED.
WARRANTY CARD IS ALSO AVAILABLE TO COMPLETE ON LINE AT YOUR CONVENIENCE.

COMPANY: _____

ADDRESS: _____

CITY: _____ STATE: _____ ZIP: _____

DEALER: _____

DATE OF PURCHASE: _____ INVOICE NUMBER: _____

SERIAL NUMBER: _____ FRYER FILTER SYSTEM GRIDDLE

REMARKS: _____ TOP-SIDE COOKER HOT PLATE PASTA PLUS

I HAVE READ THE INSTALLATION AND OPERATION INSTRUCTIONS.

SIGNED: _____ DATE: _____