

# **Lang**<sup>®</sup>

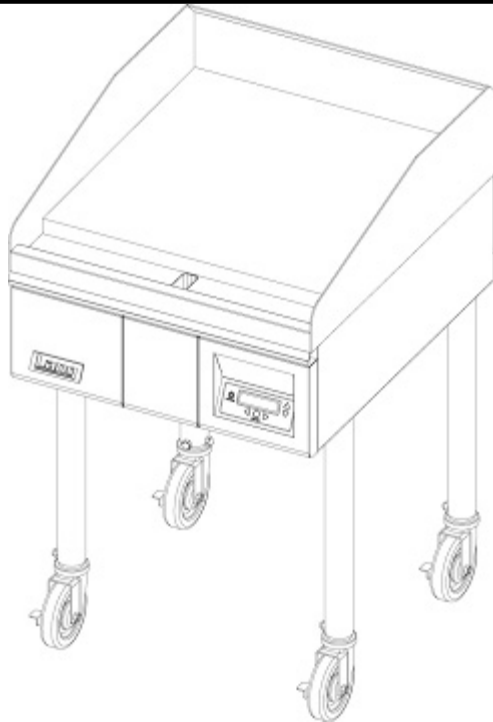

## **Installation, Operation, and Maintenance Instructions**

### **Gas Griddle**

#### **Models:**

**224Z**

**236Z**

**236ZC Chrome**

**248Z**

**260Z**

**272Z**

# Safety

**CAUTION:** THE GRIDDLE IS EXTREMELY HEAVY. FOR SAFE HANDLING, INSTALLER SHOULD OBTAIN HELP AS NEEDED, OR EMPLOY APPROPRIATE MATERIALS HANDLING EQUIPMENT (SUCH AS A FORKLIFT, DOLLY, OR PALLET JACK) TO REMOVE THE UNIT FROM THE SKID AND MOVE IT TO THE PLACE OF INSTALLATION.



**CAUTION:** ANY STAND, COUNTER OR OTHER DEVICE ON WHICH GRIDDLE WILL BE LOCATED MUST BE DESIGNED TO SUPPORT THE WEIGHT OF THE GRIDDLE.



**CAUTION:** SHIPPING STRAPS ARE UNDER TENSION AND CAN SNAP BACK WHEN CUT.



**DANGER:** THIS APPLIANCE MUST BE GROUNDED AT THE TERMINAL PROVIDED. FAILURE TO GROUND THE APPLIANCE COULD RESULT IN ELECTROCUTION AND DEATH.



**WARNING:** INSTALLATION OF THE UNIT MUST BE DONE BY PERSONNEL QUALIFIED TO WORK WITH ELECTRICITY. IMPROPER INSTALLATION CAN CAUSE INJURY TO PERSONNEL AND/OR DAMAGE TO EQUIPMENT. UNIT MUST BE INSTALLED IN ACCORDANCE WITH ALL APPLICABLE CODES.



**NOTICE:** The data plate is on top of the control box. The griddle voltage, wattage, serial number, wire size, and clearance specifications are on the data plate. This information should be carefully read and understood before proceeding with the installation.



**NOTICE:** The installation of any components such as a vent hood, grease extractors, fire extinguisher systems, must conform to their applicable National, State and locally recognized installation standards.



**NOTICE:** During the first few hours of operation you may notice a small amount of smoke coming off the unit, and a faint odor from the smoke. This is normal for a new griddle and will disappear after the first few hours of use.



**CAUTION:** ALWAYS KEEP THE AREA NEAR THE APPLIANCE FREE FROM COMBUSTIBLE MATERIALS.

**CAUTION:** KEEP FLOOR IN FRONT OF EQUIPMENT CLEAN AND DRY. IF SPILLS OCCUR, CLEAN IMMEDIATELY, TO AVOID THE DANGER OF SLIPS OR FALLS.

**THIS MANUAL MUST BE RETAINED FOR FUTURE REFERENCE. READ, UNDERSTAND AND FOLLOW THE INSTRUCTIONS AND WARNINGS CONTAINED IN THIS MANUAL.**

- DANGER**

POTENTIALLY HAZARDOUS SITUATION WHICH, IF NOT AVOIDED, COULD RESULT IN DEATH.

- WARNING**

POTENTIALLY HAZARDOUS SITUATION WHICH, IF NOT AVOIDED, COULD RESULT IN DEATH OR SERIOUS INJURY.

- CAUTION**

POTENTIALLY HAZARDOUS SITUATION WHICH, IF NOT AVOIDED, MAY RESULT IN MINOR OR MODERATE INJURY.

- NOTICE**

Helpful operation and installation instructions and tips are present.



**FOR YOUR SAFETY**  
**DO NOT STORE OR USE GASOLINE OR OTHER FLAMMABLE VAPORS AND LIQUIDS IN THE VICINITY OF THIS OR ANY OTHER APPLIANCE.**  
**POST IN A PROMINENT LOCATION**  
**INSTRUCTIONS TO BE FOLLOWED IN THE EVENT THAT THE USER SMELLS GAS, THIS INFORMATION SHALL BE OBTAINED BY CONSULTING YOUR LOCAL GAS SUPPLIER. AS A MINIMUM, TURN OFF THE GAS AND CALL YOUR GAS COMPANY AND YOUR AUTHORIZED SERVICE AGENT. EVACUATE ALL PERSONNEL FROM THE AREA.**

**WARNING: IMPROPER INSTALLATION, ADJUSTMENT, ALTERATION, SERVICE OR MAINTENANCE CAN CAUSE PROPERTY DAMAGE, INJURY OR DEATH. READ THE INSTALLATION, OPERATING AND MAINTENANCE INSTRUCTIONS THOROUGHLY BEFORE INSTALLING OR SERVICING THIS EQUIPMENT.**

<b>Model #</b>	<b>Purchased from</b>
<b>Serial #</b>	<b>Location</b>
<b>Date purchased</b>	<b>Date installed</b>
<b>Purchase order #</b>	<b>For service, call</b>

<b>CHAPTER</b>	<b>PAGE</b>
Safety .....	2
Table Of Contents .....	4
Equipment Description .....	7
Unpacking .....	9
Installation .....	10
Initial Start-Up.....	13
Operation.....	14
Cleaning Procedures.....	19
Troubleshooting.....	20
Exploded View.....	22
Parts List .....	23
Wiring Diagram.....	28

<b>CAUTION</b>	THE GRIDDLE IS EXTREMELY HEAVY. FOR SAFE HANDLING, INSTALLER SHOULD OBTAIN HELP AS NEEDED, OR EMPLOY APPROPRIATE MATERIALS HANDLING EQUIPMENT (SUCH AS A FORKLIFT, DOLLY, OR PALLET JACK) TO REMOVE THE UNIT FROM THE SKID AND MOVE IT TO THE PLACE OF INSTALLATION.
<b>CAUTION</b>	ANY STAND, COUNTER OR OTHER DEVICE ON WHICH THE GRIDDLE WILL BE LOCATED MUST BE DESIGNED TO SUPPORT THE WEIGHT OF THE GRIDDLE.
<b>CAUTION</b>	SHIPPING STRAPS ARE UNDER TENSION AND CAN SNAP BACK WHEN CUT.
<b>WARNING</b>	INSTALLATION OF THE UNIT MUST BE DONE BY PERSONNEL QUALIFIED TO WORK WITH PLUMBING. IMPROPER INSTALLATION CAN CAUSE INJURY TO PERSONNEL AND/OR DAMAGE TO EQUIPMENT. UNIT MUST BE INSTALLED IN ACCORDANCE WITH ALL APPLICABLE CODES.
<b>NOTICE</b>	The data label is located behind the front panels on the inside face of each body side. The English label is on the left; the French language label is on right. The griddle serial number, gas specifications, and clearance specifications are on the data plate. This information should be carefully read and understood before proceeding with the installation.
<b>NOTICE</b>	The installation of any components such as a vent hood, grease extractors, fire extinguisher systems, must conform to their applicable National, State and locally recognized installation standards.
<b>WARNING</b>	THIS APPLIANCE IS EQUIPPED WITH A 3-PRONG (GROUNDING) PLUG FOR YOUR PROTECTION AGAINST SHOCK HAZARD AND MUST BE PLUGGED DIRECTLY INTO A PROPERLY GROUNDED 3-PRONG RECEPTACLE. DO NOT CUT OR REMOVE THIS GROUNDING PRONG FROM THE PLUG.
<b>NOTICE</b>	When this appliance is installed with casters, it must be installed with the casters supplied, a connector complying with either ANSI Z21.69 • CSA 6.16 and a quick-disconnect device complying with ANSI Z21.41 • CSA 6.9. It must also be installed with restraining means to guard against transmission of strain to the connector as specified in the appliance manufactures instructions.
<b>NOTICE</b>	Kits designed to accommodate griddles from sea level to 5000 feet. Contact factory for orifice sizes on installations above 5000 feet.
<b>WARNING</b>	BEFORE LIGHTING, USE A SOAP AND WATER SOLUTION TO TEST ALL JOINTS FOR GAS LEAKS.
<b>NOTICE</b>	During the first few hours of operation you may notice a small amount of smoke coming off the griddle, and a faint odor from the smoke. This is normal for a new oven and will disappear after the first few hours of use.
<b>CAUTION</b>	ALWAYS KEEP THE AREA NEAR THE APPLIANCE FREE FROM COMBUSTIBLE MATERIALS.



**CAUTION**

KEEP FLOOR IN FRONT OF EQUIPMENT CLEAN AND DRY. IF SPILLS OCCUR, CLEAN IMMEDIATELY, TO AVOID THE DANGER OF SLIPS OR FALLS.

**NOTICE**

Once the griddle temperature set point has been changed, it will heat to that setting each time the griddle is turned on. Refer to “Changing the Griddle Temperature.”

**NOTICE**

In order for the Day Part feature to work properly, you must set up at least two day parts. If only one day part is set, the control will use this setting as the default temperature setting.

**WARNING**

**KEEP WATER AND SOLUTIONS OUT OF CONTROLS. NEVER SPRAY OR HOSE CONTROL CONSOLE.**

**CAUTION**

MOST CLEANERS ARE HARMFUL TO THE SKIN, EYES, MUCOUS MEMBRANES AND CLOTHING. PRECAUTIONS SHOULD BE TAKEN TO WEAR RUBBER GLOVES, GOGGLES OR FACE SHIELD AND PROTECTIVE CLOTHING. CAREFULLY READ THE WARNING AND FOLLOW THE DIRECTIONS ON THE LABEL OF THE CLEANER TO BE USED.

**NOTICE**

Never leave a chlorine sanitizer in contact with stainless steel surfaces longer than 10 minutes. Longer contact can cause corrosion.

**NOTICE**

Service on this or any other Lang Manufacturing appliance must be performed by qualified personnel only. Consult your authorized service agent directory or call the factory at 314-678-6315, or visit our website at [WWW.LANGWORLD.COM](http://WWW.LANGWORLD.COM) For the service agent nearest you.

**WARNING**

**HIGH VOLTAGE IS PRESENT INSIDE THIS APPLIANCE WHEN THE UNIT IS PLUGGED / WIRED INTO A LIVE RECEPTACLE. BEFORE REPLACING ANY PARTS, DISCONNECT THE UNIT FROM THE ELECTRIC POWER SUPPLY.**

**CAUTION**

USE OF ANY REPLACEMENT PARTS OTHER THAN THOSE SUPPLIED BY LANG OR THEIR AUTHORIZED DISTRIBUTORS CAN CAUSE BODILY INJURY TO THE OPERATOR AND DAMAGE TO THE EQUIPMENT AND WILL VOID ALL WARRANTIES.

**IMPORTANT**

The installation of the Appliance should conform to the NATIONAL FUEL GAS CODE "ANSI Z223.1/NFPA 54 - LATEST EDITION" AND ALL LOCAL GAS COMPANY RULES AND REGULATIONS. IN CANADA INSTALLATION SHALL BE IN ACCORDANCE WITH THE CURRENT CAN/CGA-B149.1 NATURAL GAS INSTALLATION CODE OR CAN/CGA-B149.2 PROPANE INSTALLATION CODE AND LOCAL CODES WHERE APPLICABLE.

# Equipment Description

## Exterior Construction

- The griddle dimensions are 17" (43.18cm) High, 30" (76.20cm) Deep, and width is dependent on the actual model number.
- The sidewall is constructed of double wall stainless steel, which allows closer installation to combustible surfaces.
- The griddle surface is made of 1¼" thick, highly polished steel to reduce hot and cold spots, recovery problems, warping, and ensure even heat to the edges of the griddle.

## Operation

- Temperature control is maintained with a single controller and one RTD probe per 12" section
- The control has factory configurable maximum and minimum temperature settings. The maximum temperature value can be set between 400°F (200°C) and 550°F (288 °C) in 5° increments. The minimum temperature value can be set between 100°F and 175°F in 5° increments.
- The controls reaction to changes in temperature is also factory configurable with a hysteresis range of 0°F (-18°C) to 10°F (-12°C).
- The controller can be calibrated to griddle surface measurements.

## Technical

- The griddle will operate on either natural gas or propane and can be easily converted in the field. Please reference the conversion instructions listed in this manual.
- It is shipped with a power cord and plug attached.
- Floor space required is 30" (76.20cm) deep, and width is 2ft, 3ft, 4ft, 5ft, or 6ft depending on actual model number.

## Griddle Gas and Voltage Specifications

- This model can be connected to any 120 Volt source. The gas and electrical specifications are listed in the table on the following page.

# Equipment Description

<b>GAS AND ELECTRICAL INPUT REQUIREMENTS</b>							
MODEL NUMBER	DESCRIPTION	TOTAL BTU INPUT		GAS CONNECTION	ELECTRICAL CONNECTION		CORD/PLUG & PRESSURE REGULATOR
		NATURAL 5" WC	PROPANE 10" WC		VOLTAGE	AMPS	
224Z	24 INCHES	54,000	54,000	ONE 3/4" NPT	115 VOLT	2	SUPPLIED
236Z	36 INCHES	81,000	81,000	ONE 3/4" NPT	115 VOLT	2	SUPPLIED
248Z	48 INCHES	108,000	108,000	ONE 3/4" NPT	115 VOLT	2	SUPPLIED
260Z	60 INCHES	135,000	135,000	ONE 3/4" NPT	115 VOLT	2	SUPPLIED
272Z	72 INCHES	162,000	162,000	ONE 3/4" NPT	115 VOLT	2	SUPPLIED

<b>SPECIFICATIONS AND INFORMATION</b>										
MODEL NUMBER	GRILL SURFACE OVERALL		SQUARE INCHES OF GRIDDLE	NUMBER OF BURNERS	NUMBER OF CONTROLS	NUMBER OF GREASE DRAWERS	CLEARANCE FROM NON-COMBUSTIBLE SURFACES			SHIPPING WEIGHT
	WIDTH	DEPTH					SIDES	BACK	BOTTOM	
224Z	24 INCHES	23 INCHES	552	2	1	1	0 INCHES	5 INCHES	4 INCH LEG	370
236Z	36 INCHES	23 INCHES	828	3	1	1	0 INCHES	5 INCHES	4 INCH LEG	500
248Z	48 INCHES	23 INCHES	1104	4	1	2	0 INCHES	5 INCHES	4 INCH LEG	650
260Z	60 INCHES	23 INCHES	1380	5	1	2	0 INCHES	5 INCHES	4 INCH LEG	780
272Z	72 INCHES	23 INCHES	1656	6	1	2	0 INCHES	5 INCHES	4 INCH LEG	920



# Unpacking

## Receiving the Griddle



Upon receipt, check for freight damage, both visible and concealed. Visible damage should be noted on the freight bill at the time of delivery and signed by the carrier's agent. Concealed loss or damage means loss or damage, which does not become apparent until the merchandise has been unpacked. If concealed loss or damage is discovered upon unpacking, make a written request for inspection by the carrier's agent within 15 days of delivery. All packing material should be kept for inspection. **Do not return damaged merchandise to Lang Manufacturing. File your claim with the carrier.**

## Location

Prior to un-crating, move the griddle as near to its intended location as practical. The crating will help protect the unit from the physical damage normally associated with moving it through hallways and doorways.

## Un-crating

The griddle will arrive completely assembled inside a wood frame and strapped to a skid. **Cut the straps and remove the wood frame.**

<b>CAUTION</b>	<b>THE GRIDDLE IS EXTREMELY HEAVY. FOR SAFE HANDLING, INSTALLER SHOULD OBTAIN HELP AS NEEDED, OR EMPLOY APPROPRIATE MATERIALS HANDLING EQUIPMENT (SUCH AS A FORKLIFT, DOLLY, OR PALLET JACK) TO REMOVE THE UNIT FROM THE SKID AND MOVE IT TO THE PLACE OF INSTALLATION.</b>	
<b>CAUTION</b>	<b>ANY STAND, COUNTER OR OTHER DEVICE ON WHICH THE GRIDDLE WILL BE LOCATED MUST BE DESIGNED TO SUPPORT THE WEIGHT OF THE GRIDDLE.</b>	
<b>CAUTION</b>	<b>SHIPPING STRAPS ARE UNDER TENSION AND CAN SNAP BACK WHEN CUT.</b>	

Remove the griddle from the skid and install the legs into the leg receiver Tubes

Place the griddle in its intended location.

**WARNING** INSTALLATION OF THE UNIT MUST BE DONE BY PERSONNEL QUALIFIED TO WORK WITH PLUMBING. IMPROPER INSTALLATION CAN CAUSE INJURY TO PERSONNEL AND/OR DAMAGE TO EQUIPMENT. UNIT MUST BE INSTALLED IN ACCORDANCE WITH ALL APPLICABLE CODES.



**NOTICE** The data label is located behind the front panels on the inside face of each body side. The English label is on the left; the French language label is on right. The griddle serial number, gas specifications, and clearance specifications are on the data plate. This information should be carefully read and understood before proceeding with the installation.



**NOTICE** The installation of any components such as a vent hood, grease extractors, fire extinguisher systems, must conform to their applicable National, State and locally recognized installation standards.



## Leg Installation

The legs are installed by sliding the threaded ends of the legs into the leg receiver tubes located in each corner of the griddle.

Slide the leg up until contact is made with the threaded nut at the top of the receiver tube. Screw the leg counter-clockwise until it is hand tight.

Tighten the setscrew on the receiver tube (one per leg).

**WARNING** THIS APPLIANCE IS EQUIPPED WITH A 3-PRONG (GROUNDING) PLUG FOR YOUR PROTECTION AGAINST SHOCK HAZARD AND MUST BE PLUGGED DIRECTLY INTO A PROPERLY GROUNDED 3-PRONG RECEPTACLE. DO NOT CUT OR REMOVE THIS GROUNDING PRONG FROM THE PLUG.



## Electrical Connection

The electrical connection must be made in accordance with local codes or in the absence of local codes with NFPA No. 70, latest edition (in Canada use: CAS STD. C22.1).

The electrical service is provided by a cord and plug located at the back of the griddle slight off center and adjacent to the gas connection.

Each griddle requires a 115-volt, 2 amp grounded supply.

**NOTICE** When this appliance is installed with casters, it must be installed with the casters supplied, a connector complying with either ANSI Z21.69 • CSA 6.16 and a quick-disconnect device complying with ANSI Z21.41 • CSA 6.9. It must also be installed with restraining means to guard against transmission of strain to the connector as specified in the appliance manufactures instructions.

## Installation cont'd

### Gas Connection

This griddle is manufactured for use with the type of gas indicted on the data label. If this does not match your gas type contact the factory and a conversion kit can be acquired.

All gas connectors must be in accordance with local codes and comply with the National Fuel Federal Gas Codes ANSI Z223.1 latest edition.

This appliance should be installed with a separate gas valve in the gas line ahead of the unit. Use a 3/4-inch or larger gas supply line.

Remove the 5/16-inch nuts securing the rear of burners. These nuts are for securing the main burners during transportation only. The rear burner shield must be removed to gain access to the nuts.

A pressure regulator for the type of gas specified is supplied with each appliance and is plumbed into the manifold. The pressure in the manifold of the appliance should be tested with a manometer and the regulator adjusted for proper pressure with the appliance operating at full fire. A 1/8-inch NPT tap is provided in the manifold for connecting a manometer.

Correct manifold pressures are:

5 inches water column for natural gas

10 inches water column for propane

When replacing the plug in the manifold, a pipe joint compound or sealant should be used that is resistant to the action of liquid petroleum gas.

Initial adjustments are the responsibility of the installer and are not chargeable to Star Manufacturing International.

After the griddle is in its final position, adjust the legs to create 1/4-inch slant from back to front. This will allow the grease to run into the grease gutter and provide the proper combustion air for the burners (the plate is installed on the griddle with the proper slope. Differential leg adjustments are required to adjust for floor or counter slope only).

## Installation cont'd

### Gas Conversions

1. Disconnect the griddle from power and close main gas supply valve.
2. Remove the front panels (remove the two hex screws on the bottom front of the body for each panel. Then lift the panels up and off from the keyhole slots).
3. Disconnect the 3/8" flex tubing from the 90° orifice fittings.
4. Remove the 90° orifice fittings from the griddle.
5. Replace the orifice spud on each of the 90° orifice fittings (making sure to apply pipe thread compound) with the new orifice spud.
6. Re-install the 90° orifice fittings into the griddle. Do not over tighten the fittings retaining nut.
7. Re-connect the 3/8" flex tubing to each of the 90° orifice fittings.
8. Remove the cap from the regulator adjustment screw.
9. Remove the regulator adjustment screw and spring from the regulator body.
10. Insert the new spring from the conversion kit and install the adjustment screw over it.
11. Place the regulator pressure range sticker over the existing pressure range sticker.
12. Place caution sticker from the conversion kit adjacent to the data label.
13. Re-connect the griddle to power.
14. Open the main gas valve and check for leaks using a soap solution.
15. Adjust gas pressure (Natural gas=5"W/C and Propane=10"W/C).
16. Install regulator adjustment screw cap.
17. Install front panels.

### Natural Gas to Propane

Part No.	Description	Qty.
<a href="#">2A-80400-12</a>	Burner orifice, drilled #53	1 per 12"
<a href="#">2V-80505-11</a>	Combination gas valve spring, includes: 1. Spring 2. Seal screw 3. Caution sticker	1

### Propane to Natural Gas

Part No.	Description	Qty.
<a href="#">2A-80400-11</a>	Burner Orifice, Drilled #43	1 per 12"
<a href="#">2V-80505-16</a>	Combination Gas Valve Spring, Includes: 1. Spring 2. Seal Screw 3. Caution Sticker	1

### NOTICE

Kits designed to accommodate griddles from sea level to 5000 feet.  
Contact factory for orifice sizes on installations above 5000 feet.



## Initial start up

### WARNING

**BEFORE LIGHTING, USE A SOAP AND WATER SOLUTION TO TEST ALL JOINTS FOR GAS LEAKS.**



### Pre-Power On

Clean the preservative coating from the griddle plate and splashguard. Add a mild detergent to hot water and wash the griddle plate and splashguard. Rinse with a damp sponge and dry with a clean rag.

Plug the unit into a 115-volt power supply.

### Power On

When the griddle is turned on for the first time, after being connected to power and gas, it may take it several tries to purge the gas lines and ignite the burners. If any of the burners fail to light during the initial trial for ignition the spark module will enter a lock out situation and the controller must be cycled off and then back on.

Once the burners ignite the griddle will automatically preheat the griddle to its default temperature of 125°F (52°). This can be preset to a different temperature at the factory if notified.

### Season the griddle (Non Chrome Surfaces)

1. When the burners go OFF, apply a thin coat of high-grade, non-salted vegetable oil to the griddle surface.
2. Rub the oil into the griddle surface with the flat side of a spatula or a towel.
3. Recoat any dry spots that appear then wait two minutes and wipe off any excess oil.
4. Repeat the seasoning process at 350°F (177°) and at 400°F (204°).

### GRIDDLE CARE (CHROMIUM SURFACES)

It takes very little time and effort to keep this Industrial Chromium griddle surface sparkling clean and performing at top efficiency. **DO NOT** allow grease to accumulate as it will carbonize and become difficult to remove. To prevent this condition the following cleaning suggestions should be followed:

1. Remove excess grease and food regularly with a 4" (100mm) wide Razor Sharp type scraper and wipe surface with a damp cloth if desired.
2. Following the scraping, for end of the day cleaning, a damp cloth and a non-silicated, nonabrasive, non-chlorinated cleaner such as Bon-Ami may be used to wipe surface clean, followed by wiping with a clean wet cloth.
3. Follow steps 2 and 3 from Griddle Care (Non-Chromium Surfaces) above.

### CAUTION

1. **Never** use pumice, griddle stones, or abrasives on a chromium surface.
2. **Never** strike a chromium griddle surface with a sharp instrument or spatula edge.
3. **Never** use steel wool.
4. **Never** use commercial liquid grill cleaner on the griddle surface.
5. **Abusing** surface voids the warranty.

### CAUTION

**ALWAYS KEEP THE AREA NEAR THE APPLIANCE FREE FROM COMBUSTIBLE MATERIALS.**



### CAUTION

**KEEP FLOOR IN FRONT OF EQUIPMENT CLEAN AND DRY. IF SPILLS OCCUR, CLEAN IMMEDIATELY, TO AVOID THE DANGER OF SLIPS OR FALLS.**



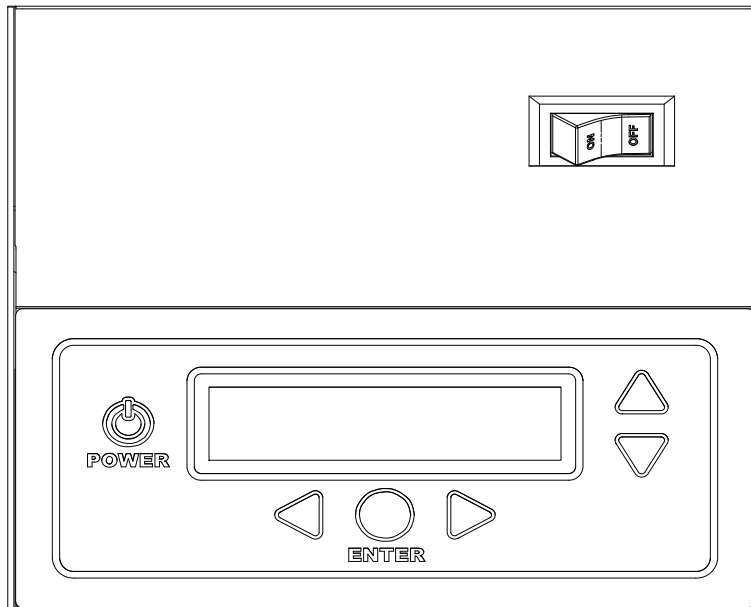

IL1813

## Control

<b>Display:</b>	2 X 20 character alfa-numeric display
<b>Left/Right Arrow:</b>	Used to enter temperature set-point override mode and to cycle from one section to the next. Also to cycle through adjustable parameters in adjust mode.
<b>Up/Down Arrow:</b>	Used to adjust parameter values. (I.E.: Temperature, Time, Yes/No).
<b>Enter:</b>	Used to enter adjustments into program memory, cycle to the next adjustable parameter and/or return to normal operation.
<b>Switch:</b>	(HE models only) This switch turns on the power to the Clamshell® Hood. When not using the hood, have this in the "OFF" position.

## Starting the Griddle

Press the "Power" button.

The control will conduct a self test then display "**Control ready**". At this time the ignition sequence will begin. Each burner will light and the control will heat to the current temperature set point.

**NOTICE** Once the griddle set point temperature has been changed, it will heat to that setting each time the griddle is turned on. Refer to "Changing the Griddle Temperature."



As the griddle heats, the display will scroll through the griddle sections displaying the burner status, actual temperature, and temperature set point.

### Changing the Griddle Temperature "On-the-Fly"

There are three ways to set/adjust set point temperatures for this griddle. The first and simplest way is "On-the-Fly". Make changes to temperature set points as follows:

- While in normal operation, press either the LEFT or RIGHT arrow button. The display indicates the current griddle section number and set point temperature.
- Use UP or DOWN arrows to increase or decrease the temperature value.
- When the change for the first section is complete press the left or right arrow button to proceed to the next section or press the ENTER button to return to normal operation.

The control will handle "On-the-Fly" temperature settings differently depending on whether or not current "Fixed Set Points" or "Day Parts", (see Manager Level Settings below), are in use. If neither "Fixed Set Points" nor "Day Parts" are setup the "On-the-Fly" settings will remain in effect until changed by the method indicated above, or until "Fixed Set Points" or "Day Parts" are input. If "Fixed Set Points" are setup, any "On-the-Fly" changes will be removed at Midnight. If "Day Parts" are setup, any "On-the-Fly" changes will be removed at the beginning of the next "Day Part".

### Manage the Level Settings (MLS)

Turn the griddle on by pressing the Power button.

Press and hold the "Enter" and the "Up" arrow buttons for five seconds. If a user access code as been set, the display will prompt for the access code now. If not it will prompt for an "L or R" arrow button, this will scroll through one of ten Manager level settings.

### Number of Sections

This setting should only be changed if installing a new controller.

Use the up or down arrow buttons to set the number of sections. The number of sections is determined by measuring (one section per foot) or counting the burners (one section per burner).

Once the number of sections is set press the ENTER button and this will advance you to the next setting.

### Setting the Clock

The clock is only necessary if "Fixed Set Points" or "Day Parts" are set up. If no "Fixed Set Points" or "Day Parts" are setup there is no reason to set the clock, as it will not be displayed.

Setting the time starts with the Hour. Use the UP and DOWN arrow buttons to set the correct hour then press ENTER to move the Minute and then to AM/PM. Pressing ENTER after AM/PM is set will save changes.

### Setting the Calibration

This setting should only be changed by authorized personal and only with temperature sensing devices that are authorized by the manufacturer.

Calibration adjustments always start with section 1. Use the UP and DOWN arrow buttons to adjust the displayed temperature to match the temperature sensed at the center of the sections top surface. Press the ENTER button to move to the next section. When the last section has been calibrated pressing the ENTER button will save the changes.

## Operation cont'd.

### Setting the Temperature Unit

This setting allows the operator to change from Fahrenheit (F) to Celsius (C).

Use the Up or Down arrow to toggle between Fahrenheit (F) and the Celsius (C) display and Enter to save the changes.

### Setting Fixed Set Point Temperatures

Fixed set point temperatures provide for a more reliable temperature setting when normal procedures call for only one temperature setting per section all day long. If set points are changed "On-the-Fly", for special Products and the operator forgets to change settings back to normal values, The control will remove the "On-the-Fly" changes at midnight. Setting up "Fixed Set Points" starts with section 1. Use the UP and DOWN arrow buttons to adjust the temperature. Press the ENTER button to move to the next section. When the last section's temperature is set, pressing the ENTER will save the new set point values. The control will then prompt to set the clock.

### Day Part

"Day Parts" provide for a reliable means of setting temperatures when normal procedures require the use of multiple temperature settings per section throughout the day. As many as six different "Day Parts" can be defined. If set points are changed "On-The-Fly", for special products and the operator forgets to change the settings back to the normal values, the control will remove the "On-the-Fly" changes at the beginning of the next "Day Part".

Setting up "Day Parts" begins with the control indicating the number of current "Day Parts" setup and prompting for the user to indicate whether "Day Parts" are to be edited or deleted. Use the UP or DOWN arrow buttons to indicate EDIT or DELETE then press ENTER.

If EDIT is selected and no "Day Parts" currently exist, the control asks if a new "Day Parts" is to be added. Use the UP or DOWN to toggle between YES and NO then press ENTER. If YES is selected the control displays the new "Day Part" number (1-6) and prompts for setting the "Day Part" start time. Once the start time is set the control indicates the section number, the "Day Part" number, and a temperature value. Use the UP and DOWN arrow buttons to adjust the temperature value then press ENTER to advance to the next section. When all of the temperature set points have been adjusted and entered, the controller either asks if the user wants to add another "Day Part" or immediately prompts for setting the clock if six "Day Parts" have been setup.

If EDIT is selected with existing "Day Parts", the control displays the first "Day Parts" start time. Use the UP and DOWN to adjust the start time. Once the start time is set the control indicates the section number, the "Day Part" number, and a temperature value. Adjust start times and set point temperatures as indicated above. When all existing "Day Parts" have been updated the control asks if a new "Day Part" is to be added. If YES is selected add "Day Parts" as indicated above. If NO is selected the controller will prompt for setting the clock.

If DELETE is selected the control will go through the existing "Day Parts" one at a time asking if the user wishes to delete the displayed "Day Part". Use the UP and DOWN arrows to select YES or NO and press ENTER.

### Notice

**In order for the Day Part feature to work properly, you must set the two-start time. If only one start time is set, the control will use this setting as the default temperature setting. If the temperature is changed anytime during the Day Part, the control will revert to the Day Part temperature at the appropriate time set for that "Day Part".**



## Operation cont'd.

### Turning the Buzzer Alarms Off/On

This setting allows the operator to turn the audio (buzzer) temperature alarms off or on. Use the up or down arrow to toggle between "Off" or "On". Press the ENTER button to save selection.

### Turning the Display Alarms Off/On

This setting allows the operator to turn the visual (display) temperature alarms off or on. Use the up or down arrow to toggle between "Off" or "On". Press the ENTER button to save selection.

## Alarms

Several alarms exist within the control. These alarms are used as information only messages or to alert the operator that an unsafe condition may exist.

Alarm	Description	Test
<b>Slow Warm Up</b>	Griddle takes too long to get to operating temperature.	Verify Main Burner ignition, (Spark Gap, Spark Module, Wiring between Spark Module and Spark Probe) Gas Pressure, (5 inches WC NG, 10 inches WC LP) and Temperature Sense Probe operation.
<b>Low Temp</b>	Griddle falls more than 25°F (-4°C) below set temperature.	Verify main burner ignition, (Spark Gap, Spark Module, Wiring between Spark Module and Spark Probe) Gas Pressure, (5" WC NG, 10 " WC LP) and Temperature Sense Probe operation. Review Griddle Loading. Was Griddle load excessive?
<b>High Temp</b>	Griddle rises more than 25°F (-4°C) above set temperature	Check probe, board, and valve for normal operation.
<b>Failed Temp Probe</b>	Griddle temperature-sensing probe fails	Check probe for normal operation

## Operation cont'd.

### **Temperature Adjust Lockout**

The Temperature Adjust Lockout when activated prevents “On-the-Fly” changes to temperature “Fixed Set Points”. To activate Set Temp Adjust Lockout use the UP or DOWN arrow button to select YES then press ENTER.

### **Access Code**

This Setting when activated will not allow entry into the Manager Level Settings without First entering the access code.

Use the Up or Down arrow to toggle between YES and NO. If YES is selected the user will be prompted for a three key access code. Select any three key combination as the access code (example: Left arrow Down arrow Enter). Once code is confirmed, press Enter to save.

### **Reset Factory Defaults**

This setting when activated will reset all settings back to the configuration that left the factory. It may sometimes be faster and easier to erase all the presets then to go through and change everything individually.

Use the Up or Down arrow to toggle between Yes and No. Once selected, press Enter to advance to the next setting.

### **Exit User Adjust**

Pressing Enter at this screen will exit the user from the Manager Level Settings and return the griddle to normal operation.

Use the Up or Down arrow to toggle between Yes and No. Pressing Enter with YES selected will return the griddle to normal operation. Pressing Enter with NO selected will return to the start of the (MLS) menu.

## WARNING

**KEEP WATER AND SOLUTIONS OUT OF CONTROLS. NEVER SPRAY OR HOSE CONTROL CONSOLE.**



## CAUTION

**MOST CLEANERS ARE HARMFUL TO THE SKIN, EYES, MUCOUS MEMBRANES AND CLOTHING. PRECAUTIONS SHOULD BE TAKEN TO WEAR RUBBER GLOVES, GOGGLES OR FACE SHIELD AND PROTECTIVE CLOTHING. CAREFULLY READ THE WARNING AND FOLLOW THE DIRECTIONS ON THE LABEL OF THE CLEANER TO BE USED.**



## NOTICE

**Never leave a chlorine sanitizer in contact with stainless steel surfaces longer than 10 minutes. Longer contact can cause corrosion.**



## Daily Cleaning

Empty the grease drawer daily or whenever it is 3/4 full. It is easily removed for washing.

Keep the griddle surface clean. After each cooking load, scrape the griddle surface to remove any carbonized grease.

Once a day or when necessary the griddle surface should be thoroughly cleaned and seasoned again. Use a griddle stone, griddle pad, or liquid cleaner. Rub with the grain of the metal, being careful not to scrape the splashguard.

## Weekly Cleaning

A mild detergent with water or one of the many commercial cleaners may be used.

Be sure to rinse thoroughly and coat the griddle with a thin film of oil to prevent rusting.

Clean the exterior of the appliance with hot water and a mild detergent to maintain a gleaming appearance.

Re-season the griddle plate after each cleaning.

**KEEP WATER AND SOLUTIONS OUT OF CONTROLS. NEVER SPRAY OR HOSE CONTROL CONSOLE.**



## WARNING

## CAUTION

**MOST CLEANERS ARE HARMFUL TO THE SKIN, EYES, MUCOUS MEMBRANES AND CLOTHING. PRECAUTIONS SHOULD BE TAKEN TO WEAR RUBBER GLOVES, GOGGLES OR FACE SHIELD AND PROTECTIVE CLOTHING. CAREFULLY READ THE WARNING AND FOLLOW THE DIRECTIONS ON THE LABEL OF THE CLEANER TO BE USED.**



## NOTICE

**Never leave a chlorine sanitizer in contact with stainless steel surfaces longer than 10 minutes. Longer contact can cause corrosion.**



## Burner Air Shutter Adjustment

Periodically inspect and clean the air shutters to insure complete combustion.

Remove the flu from the back of griddle and gently pull the burner out of the grill.

The air shutters are pre-set at the factory. However, minor adjustments may be required in the field to accommodate differences in gas and elevation. To adjust the air shutters, loosen the setscrew holding the air damper to the burner near the gas inlet. Adjust the air mixture until the burner flame just flickers on the burner. "Lift-off" or yellow flame indicates improper shutter adjustment.

**NOTICE** Service on this or any other Lang Manufacturing appliance must be performed by qualified personnel only. Consult your authorized service agent directory or call the factory at 314-678-6315, or visit our website at [WWW.LANGWORLD.COM](http://WWW.LANGWORLD.COM) for the service agent nearest you.



**WARNING** BOTH HIGH AND LOW VOLTAGES ARE PRESENT INSIDE THIS APPLIANCE WHEN THE UNIT IS PLUGGED/WIRED INTO A LIVE RECEPTACLE. BEFORE REPLACING ANY PARTS, DISCONNECT THE UNIT FROM THE ELECTRIC POWER SUPPLY.



**CAUTION** USE OF ANY REPLACEMENT PARTS OTHER THAN THOSE SUPPLIED BY LANG OR THEIR AUTHORIZED DISTRIBUTORS CAN CAUSE BODILY INJURY TO THE OPERATOR AND DAMAGE TO THE EQUIPMENT AND WILL VOID ALL WARRANTIES.



Troubleshooting is not an exact science. Several factors may play a part in why your machine is not operating correctly. The following symptoms are a general idea of what may be causing the malfunction and should not be considered the complete answer to the situation that you have with your machine. Here are some of the possible problems you may encounter and possible solutions to those problems. If the information does not assist you in correcting the problem, contact the nearest Lang service representative or Star Manufacturing International.

Refer to the Symptoms column to locate the type of failure then to the Possible Cause for the items to be checked.

To test for a possible cause, refer to the TEST section and locate the Possible Cause then refer to test to identify test procedures.

Symptom	Possible Cause	Test
Controller will not come on.	Griddle not plugged in Control power not connected No power at plug	Check power cord connection Check connection of the pin connector on the control Verify plug has power.
All griddle sections spark but none will light.	Gas supply not connected or turned on. Gas supply not purged of air.	Check gas connections and gas valve Try Ignition sequence again
A section sparks but will not light	Gas valve failed Spark module, valve output failed Spark probe misaligned Sparking away from spark probe.	Apply 120-volts to valve and listen for solenoid actuation. Check voltage between wires connected to valve after heat call and while igniter is sparking (should be 120-volts) Visually inspect spark probe Visually inspect spark probe
One section does not spark	Main Connector on spark module not plugged in properly Heat call (power from controller) not reaching spark module Spark Module Failed	Verify connection Check wiring Replace module

## Troubleshooting Cont'd

Symptom	Possible Cause	Test
Controller prompts "Section X Failed Temp Probe"	RTD not properly connected at Probe or Controller. RTD Failed	Verify connections. Replace RTD.
Controller prompts "Section X Low Temp"	Burner Failed to light on Heat Call (See symptoms "One section does not spark" or "One sections sparks but does not light") Failed Probe Griddle Overloading.	Verify Main Burner ignition. Verify Gas Pressure. Verify Temperature Probe operation. Review Griddle Loading.
Controller prompts "Section X High Temp"	Solenoid Failed to close Controller "Heat Call" output failed on	Check solenoid for normal operation. Check controller outputs.

### CAUTION

**USE OF ANY REPLACEMENT PARTS OTHER THAN THOSE SUPPLIED BY LANG OR THEIR AUTHORIZED DISTRIBUTORS CAN CAUSE BODILY INJURY TO THE OPERATOR AND DAMAGE TO THE EQUIPMENT AND WILL VOID ALL WARRANTIES.**



### GG Griddle Wire Harness Description

Part #	Description
141-701	Wire Harness #1-GG Short harness plugs on the module works in lanes #3 and #4
141-702	Wire Harness #2-GG Middleharness plugs on the module works in lanes #2 and #5
141-703	Wire Harness #3-GG Long Harness plugs in the module works in lands #1 and #6
141-704	Wire Harness #4-GG Power input wire with ferrite plugs into the computer board 120V feed
141-704	Wire Harness #4-GG Power input wire for units with CSE12 Clamshell® hoods with ferrite plugs into the computer board 120V feed
141-705	Wire Harness #5-GG Spark wire plugs into module to the electrode. High voltage wire

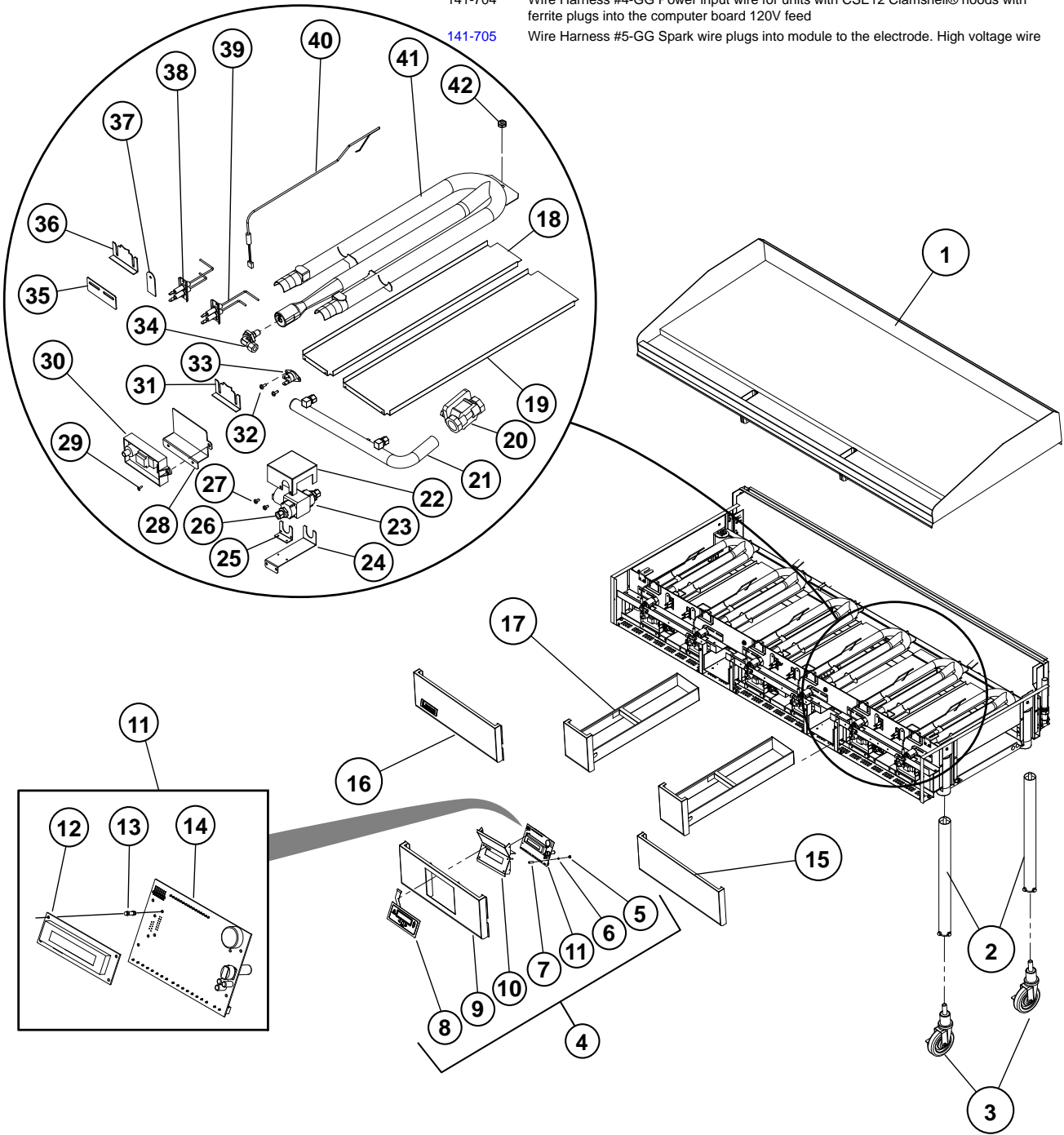

224Z - 272Z EnviroZone Gas Griddle  
GG EnviroZone Gas Griddle

**Lang**<sup>®</sup>

SK2306

Rev. A 4/04/11

# PARTS LIST

October 12, 2011, Rev F

## Model No: 224Z-NAT, 224ZC-LP, 224ZHE-NAT/LP ChefSeries Gas EnvioZone Griddle

Key Number	Part Number	Qty Per	Description	
1	K9-141-201-2	1	PLATE ASSY - 2'	224Z-NAT/LP
	K9-141-201-21	1	PLATE ASSY - 2' W/AGC	224ZHG
	K9-141-201-22	1	PLATE ASSY - 2' W/XLH12	224ZHE
	K9-141-201-26	1	PLATE ASSY - 2' CHROME	224ZC-LP
	K9-141-201-W261	1	PLATE ASSY - 2' CHROME W/CHE	224ZCHE
2	2A-72500-20	4	LEG 10.25 WITH ADJ HEX	224Z-NAT, ZC-LP
	2A-72901-34	4	LEG STD 2.0D X 24.625" SS	224Z-NATJBT
4	K9-141-231-2	1	CONTROL PANEL ASSY - 2'	224Z-NAT, ZC-LP
	K9-141-231-2-W1	1	CTRL PNL ASSY-2'/SWITCH	224ZHE, 224ZCHE
5	2C-20301-10	4	NUT HEX 6-32 PLTD	224Z-NAT, ZC-LP
6	2C-20205-02	4	.140#6IDX.2500DX.032	224Z-NAT, ZC-LP
7	2A-20504-07	4	SPACER #6 1/4 X 13/16	224Z-NAT, ZC-LP
8	2M-60301-153	1	LABEL PANEL 141 GRIDDLE	224Z-NAT, ZC-LP
9	K9-141-236-01	1	CONTROL PANEL 2'	224Z-NAT, ZC-LP
10	K9-141-232	1	CONTROL RECESS ASSY	224Z-NAT, ZC-LP
	K9-141-232-W1	1	CTRL RECESS ASSY-W/SWITCH	224ZHE, 224ZCHE
11	K9-40102-61	1	GRIDDLE CONTROL-SAGE	224Z-NAT, ZC-LP
12	2J-40102-61-1	1	DISPLAY FOR GG & GE	224Z-NAT, ZC-LP
13	2K-70801-33	4	SPACER SUPPORT NYLON	224Z-NAT, ZC-LP
14	2J-40102-61-4	1	GRIDDLE CTRL-GG MAIN BD	224Z-NAT, ZC-LP
16	k9-141-241-2	1	FRNT PNEL LH ASY 2' TO 5'	224Z-NAT, ZC-LP
17	K9-141-251	1	GREASE DRAWER ASSY	224Z-NAT, ZC-LP
18	K9-141-181	2	BAFFLE UNDER BURNER	224Z-NAT, ZC-LP
20	2V-80501-04	1	GAS REG 3/4X3/4 CLS I	224Z-NAT
	2V-80501-05	1	GAS REG 3/4X3/4 CLS II	224ZC-LP
21	K9-141-157-2	1	MANIFOLD ASSY - 2'	224Z-NAT, ZC-LP
22	K9-141-156-3	2	VALVE SHIELD	224Z-NAT, ZC-LP
23	2V-80502-04	2	SOLENOID VALVE 120VAC 1/2PIPE	224Z-NAT, ZC-LP
24	K9-141-156-1	2	VALVE MOUNT BASE	224Z-NAT, ZC-LP
25	K9-141-156-2	2	VALVE MOUNT FRONT FLANGE	224Z-NAT, ZC-LP
26	2K-70101-11	4	BRAS TBE UNON 3/8CC-1/2	224Z-NAT, ZC-LP
27	2C-20102-12	4	SCRW PHD ST 10-32X3/8 PLTD T23	224Z-NAT, ZC-LP
28	K9-141-152	2	SPARK MODULE MOUNT	224Z-NAT, ZC-LP
29	2C-20102-04	4	SCRW PHD ST 8-32X.5 PLTD	224Z-NAT, ZC-LP
30	2J-80300-17	2	SPRK IGN CNTRL 141	224Z-NAT, ZC-LP
31	K9-141-146	2	PROBE GUARD SUPPORT	224Z-NAT, ZC-LP
32	2C-20103-06	2	SCRW SM PLT 6 X 3/8 PHL	224Z-NAT, ZC-LP
33	2T-30401-29	1	STAT FXD 435 DEG OPEN	224Z-NAT, ZC-LP
34	2A-W1185	2	ORIFICE FITTING - 90 DEG	224Z-NAT, ZC-LP
35	K9-141-150	2	BURNRER GROUND BRACKET	224Z-NAT, ZC-LP
36	K9-141-146	2	PROBE GUARD SUPPORT	224Z-NAT, ZC-LP
37	K9-141-145	2	VIEW PORT COVER	224Z-NAT, ZC-LP
38	2E-80302-10	1	DSI PROBE LEFT 141	224Z-NAT, ZC-LP
39	2E-80302-11	1	DSI PROBE RIGHT 141	224Z-NAT, ZC-LP
40	PS-JIB-SEN-ENV	2	KIT, PROBE ENVIROZONE GG	224Z-NAT, ZC-LP
41	K9-141-171-1	2	BURNER ASSY	224Z-NAT, ZC-LP
42	2C-20307-02	2	NUT - NYLON 5/16 - 18	224Z-NAT, ZC-LP
NI	2E-31107-02	1	CORD SET 14/3 X 8' 15A	224Z-NAT, ZC-LP
NI	2E-Z9592	1	SWITCH, ROCKER	224ZHE, 224ZCHE
NI	2K-70104-02	2	FLEXIBLE TUBE 3/8OD X 10	224Z-NAT, ZC-LP
NI	2K-70104-03	1	FLEXIBLE TUBE 3/8OD X 8	224Z-NAT, ZC-LP
NI	2K-70104-04	1	FLEXIBLE TUBE 3/8OD X 12	224Z-NAT, ZC-LP
NI	Y9-80400-11	2	ORIFICE HOOD .0935 # 42	224Z-NAT
NI	Y9-80400-12	2	ORIFICE HOOD .0595 #53	224ZC-LP

**IMPORTANT: WHEN ORDERING, SPECIFY VOLTAGE OR TYPE GAS DESIRED  
INCLUDE MODEL AND SERIAL NUMBER**

PAGE 1  
OF 1

Some items are included for illustrative purposes only and in certain instances may not be available.



# PARTS LIST

October 12, 2011, Rev F

## Model No: 236Z-NAT/LP, 236ZC-NAT, 236Z-NATJBT, 236ZHE-NAT/LP, 236ZHG-LP/NAT ChefSeries Gas EnvioZone Griddle

Fig No.	Part Number	Qty	Description	Application
1	K9-141-201-3	1	PLATE ASSY - 3'	236Z
	K9-141-201-31		PLATE ASSY - 3' W/AGC	236ZHG
	K9-141-201-36		PLATE ASSY - 3' CHROME	236ZC
	K9-141-201-3-W1		PLATE ASSY - 3' W/XLH12	236ZHE
	K9-141-201-W361		PLATE ASSY - 3' CHROME GROOVED	236ZCHG
2	2A-72500-20	4	LEG 10.25 WITH ADJ HEX	236Z-NAT
	K9-141-115		TALL LEG ASSY - GG & GE	236Z-NATJBT
3	2P-72901-33	4	CSTR 5 ADJ FOR 72901-34	236Z-NATJBT
4	K9-141-231-3	1	CONTROL PANEL ASSY - 3'	236Z
	K9-141-231-3-W1		CTRL PNL ASSY-3' W/SWITCH	236ZHE, 236ZHG
5	2C-20301-10	4	NUT HEX 6-32 PLTD	236Z
6	2C-20205-02	4	.140#6IDX.2500DX.032	236Z
7	2A-20504-07	4	SPACER #6 1/4 X 13/16	236Z
8	2M-60301-153	1	LABEL PANEL 141 GRIDDLE	236Z
9	K9-141-236-03	1	CONTROL PANEL 3'	236Z
10	K9-141-232	1	CONTROL RECESS ASSY	236Z
	K9-141-232-W1		CTRL RECESS ASSY-W/SWITCH	236ZHE, 236ZHG
11	K9-40102-61	1	GRIDDLE CONTROL-SAGE	236Z
12	2J-40102-61-1	1	DISPLAY FOR GG & GE	236Z
13	2K-70801-33	4	SPACER SUPPORT NYLON	236Z
14	2J-40102-61-4	1	GRIDDLE CTRL-GG MAIN BD	236Z
16	k9-141-241-2	1	FRNT PNEL LH ASY 2' TO 5'	236Z
17	K9-141-251	1	GREASE DRAWER ASSY	236Z
18	K9-141-181	3	BAFFLE UNDER BURNER	236Z
20	2V-80501-04	1	GAS REG 3/4X3/4 CLS I	236Z-NAT
	2V-80501-05		GAS REG 3/4X3/4 CLS II	236Z-LP
21	K9-141-157-3	1	MANIFOLD ASSY - 3'	236Z
22	K9-141-156-3	3	VALVE SHIELD	236Z
23	2V-80502-04	3	SOLENOID VALVE 120VAC 1/2PIPE	236Z
24	K9-141-156-1	3	VALVE MOUNT BASE	236Z
25	K9-141-156-2	3	VALVE MOUNT FRONT FLANGE	236Z
26	2K-70101-11	6	BRAS TBE UNON 3/8CC-1/2	236Z
27	2C-20102-12	6	SCRW PHD ST 10-32X3/8 PLTD T23	236Z
28	K9-141-152	3	SPARK MODULE MOUNT	236Z
30	2J-80300-17	3	SPRK IGN CNTRL 141	236Z
31	2C-20102-04	6	SCRW PHD ST 8-32X.5 PLTD	236Z
32	2C-20103-06	2	SCRW SM PLT 6 X 3/8 PHL	236Z
33	2T-30401-29	1	STAT FXD 435 DEG OPEN	236Z
34	2A-W1185	3	ORIFICE FITTING - 90 DEG	236Z
35	K9-141-150	3	BURNRER GROUND BRACKET	236Z
36	K9-141-146	3	PROBE GUARD SUPPORT	236Z
37	K9-141-145	3	VIEW PORT COVER	236Z
38	2E-80302-10	1	DSI PROBE LEFT 141	236Z
39	2E-80302-11	1	DSI PROBE RIGHT 141	236Z
40	PS-JIB-SEN-ENV	3	KIT, PROBE ENVIROZONE GG	236Z
41	K9-141-171-1	3	BURNER ASSY	236Z
42	2C-20307-02	3	NUT - NYLON 5/16 - 18	236Z
NI	2E-31107-02	1	CORD SET 14/3 X 8' 15A	236Z
NI	2E-Z9592	1	SWITCH, ROCKER	236ZHE
NI	2K-70104-02	3	FLEXIBLE TUBE 3/8OD X 10	236Z
NI	2K-70104-03	2	FLEXIBLE TUBE 3/8OD X 8	236Z
NI	2K-70104-04	1	FLEXIBLE TUBE 3/8OD X 12	236Z
NI	Y9-80400-11	3	ORIFICE HOOD .0935 # 42	236Z



# PARTS LIST

October 12, 2011, Rev F

**Model No: 248Z-NAT, 248Z-NATSC, 248Z-LPSC, 248ZHE-NAT/LP  
ChefSeries Gas EnvioZone Griddle**

Key Number	Part Number	Qty Per	Description
1	K9-141-201-4	1	PLATE ASSY - 4' 248Z
	K9-141-201-46	1	PLATE ASSY - 4' CHROME 248ZC
	K9-141-201-4-W1	1	PLATE ASSY - 4' W/XLH12 248ZHE
2	2A-72500-20	4	LEG 10.25 WITH ADJ HEX 248Z
4	K9-141-231-4	1	CONTROL PANEL ASSY - 4' 248Z
	K9-141-231-4-W1	1	CTRL PNL ASSY-4' W/SWITCH 248ZHE
5	2C-20301-10	4	NUT HEX 6-32 PLTD 248Z
6	2C-20205-02	4	.140#6IDX.2500DX.032 248Z
7	2A-20504-07	4	SPACER #6 1/4 X 13/16 248Z
8	2M-60301-153	1	LABEL PANEL 141 GRIDDLE 248Z
9	K9-141-236-02	1	CONTROL PANEL 4' & 6' 248Z
10	K9-141-232	1	CONTROL RECESS ASSY 248Z
	K9-141-232-W1	1	CTRL RECESS ASSY-W/SWITCH 248ZHE
11	K9-40102-61	1	GRIDDLE CONTROL-SAGE 248Z
12	2J-40102-61-1	1	DISPLAY FOR GG & GE 248Z
13	2K-70801-33	4	SPACER SUPPORT NYLON 248Z
14	2J-40102-61-4	1	GRIDDLE CTRL-GG MAIN BD 248Z
16	K9-141-241-4	1	FRNT PNEL RH ASSY 4' & 5' 248Z
17	K9-141-251	2	GREASE DRAWER ASSY 248Z
	K9-141-437	2	GREASE DRAWER ASSY - REAR GTR 248Z-NATSC, 248Z-LPSC
18	K9-141-181	4	BAFFLE UNDER BURNER 248Z
19	K9-141-182	1	BAFFLE BETWEEN BURNERS 248Z-NAT, 248-NATSC, 248Z-LPSC
20	2V-80501-04	1	GAS REG 3/4X3/4 CLS I 248Z-NAT, 248-NATSC
	2V-80501-05	1	GAS REG 3/4X3/4 CLS II 248Z-LPSC
21	K9-141-157-4	1	MANIFOLD ASSY - 4' 248Z
22	K9-141-156-3	4	VALVE SHIELD 248Z
23	2V-80502-04	4	SOLENOID VALVE 120VAC 1/2PIPE 248Z
24	K9-141-156-1	4	VALVE MOUNT BASE 248Z
25	K9-141-156-2	4	VALVE MOUNT FRONT FLANGE 248Z
26	2K-70101-11	8	BRAS TBE UNON 3/8CC-1/2 248Z
27	2C-20102-12	8	SCRW PHD ST 10-32X3/8 PLTD T23 248Z
28	K9-141-152	4	SPARK MODULE MOUNT 248Z
29	2C-20102-04	8	SCRW PHD ST 8-32X.5 PLTD 248Z
30	2J-80300-17	4	SPRK IGN CNTRL 141 248Z
31	K9-141-146	4	PROBE GUARD SUPPORT 248Z
32	2C-20103-06	2	SCRW SM PLT 6 X 3/8 PHL 248Z
33	2T-30401-29	1	STAT FXD 435 DEG OPEN 248Z
34	2A-W1185	4	ORIFICE FITTING - 90 DEG 248Z
35	K9-141-150	4	BURNER GROUND BRACKET 248Z
37	K9-141-145	4	VIEW PORT COVER 248Z
38	2E-80302-10	2	DSI PROBE LEFT 141 248Z
39	2E-80302-11	2	DSI PROBE RIGHT 141 248Z
40	PS-JIB-SEN-ENV	4	KIT, PROBE ENVIROZONE GG 248Z
41	K9-141-171-1	4	BURNER ASSY 248Z
42	2C-20307-02	4	NUT - NYLON 5/16 - 18 248Z
NI	2E-31107-02	1	CORD SET 14/3 X 8' 15A 248Z
NI	2E-Z9592	1	SWITCH, ROCKER 248ZHE
NI	2K-70104-02	4	FLEXIBLE TUBE 3/8OD X 10 248Z
NI	2K-70104-03	4	FLEXIBLE TUBE 3/8OD X 8 248Z
NI	Y9-80400-11	4	ORIFICE HOOD .0935 # 42 248Z-NAT
NI	Y9-80400-12	4	ORIFICE HOOD .0595 #53 248Z-LPSC

**IMPORTANT: WHEN ORDERING, SPECIFY VOLTAGE OR TYPE GAS DESIRED  
INCLUDE MODEL AND SERIAL NUMBER**

PAGE 1  
OF 1

Some items are included for illustrative purposes only and in certain instances may not be available.



# PARTS LIST

October 12, 2011, Rev F

## Model No: 260Z-NAT, 260ZB-NATLH, 260ZC-NATCU, 260ZHE-NAT ChefSeries Gas EnvioZone Griddle

Key Number	Part Number	Qty Per	Description	
1	K9-141-201-5	1	PLATE ASSY - 5'	260Z
	K9-141-201-52	1	PLATE ASSY - 5' W/XLH12	260ZHE
	K9-141-205-54	1	PLATE ASSY - 5' SIDE	260ZC-NATCU
	K9-141-433-51	1	PLATE ASY 5' RR GTR	260ZB-NATLH
2	2A-72500-20	4	LEG 10.25 WITH ADJ HEX	260Z-NAT
	K9-141-115	4	LEG STD 2 OD X 24.625	260ZC-NATCU
3	2P-72901-33	4	CSTR 5 ADJ FOR 72901-34	260ZC-NATCU
4	K9-141-231-5	1	CONTROL PANEL ASSY - 5'	260Z
	K9-141-231-5-W1	1	CTRL PNL ASSY-5' W/SWITCH	260ZHE
5	2C-20301-10	4	NUT HEX 6-32 PLTD	260Z
6	2C-20205-02	4	.140#6IDX.2500DX.032	260Z
7	2A-20504-07	4	SPACER #6 1/4 X 13/16	260Z
8	2M-60301-153	1	LABEL PANEL 141 GRIDDLE	260Z
9	K9-141-236-02	1	CONTROL PANEL 4' & 6'	260Z
10	K9-141-232	1	CONTROL RECESS ASSY	260Z
	K9-141-232-W1	1	CTRL RECESS ASSY-W/SWITCH	260ZHE
11	K9-40102-61	1	GRIDDLE CONTROL-SAGE	260Z
12	2J-40102-61-1	1	DISPLAY FOR GG & GE	260Z
13	2K-70801-33	4	SPACER SUPPORT NYLON	260Z
14	2J-40102-61-4	1	GRIDDLE CTRL-GG MAIN BD	260Z
15	K9-141-245-4	1	FRNT PNL RH ASSY 4' & 5'	260Z
	K9-141-245-54	1	FRONT PNL ASSY RH 5' SIDE	260ZC-NATCU
16	K9-141-241-54	1	FRONT PNL ASSY LH 5' SIDE	260ZC-NATCU
	K9-141-241-6	1	FRONT PANEL LH ASSY 6'	260Z
17	K9-141-251	2	GREASE DRAWER ASSY	260Z
	K9-XL-670	1	GREASE BUCKET ASSY RH	260ZC-NATCU
	K9-XL-675	1	GREASE BUCKET ASSY LH	260ZC-NATCU
	K9-XL-689	1	GREASE BUCKET ASSY RH LGR	260ZB-NATLH
	K9-XL-692	1	GREASE BUCKET ASSY LG LGR	260ZB-NATLH
18	K9-141-181	5	BAFFLE UNDER BURNER	260Z
19	K9-141-182	2	BAFFLE BETWEEN BURNERS	260Z
	K9-141-182	4	BAFFLE BETWEEN BURNERS	260ZB-NATLH
20	2V-80501-04	1	GAS REG 3/4X3/4 CLS I	260Z
21	K9-141-157-5	1	MANIFOLD ASSY - 5'	260Z
22	K9-141-156-3	5	VALVE SHIELD	260Z
23	2V-80502-04	5	SOLENOID VALVE 120VAC 1/2PIPE	260Z
24	K9-141-156-1	5	VALVE MOUNT BASE	260Z
25	K9-141-156-2	5	VALVE MOUNT FRONT FLANGE	260Z
26	2K-70101-11	10	BRAS TBE UNON 3/8CC-1/2	260Z
27	2C-20102-12	10	SCRW PHD ST 10-32X3/8 PLTD T23	260Z
28	K9-141-152	5	SPARK MODULE MOUNT	260Z
29	2C-20102-04	10	SCRW PHD ST 8-32X.5 PLTD	260Z
30	2J-80300-17	5	SPRK IGN CNTRL 141	260Z
31	K9-141-146	5	PROBE GUARD SUPPORT	260Z
32	2C-20103-06	2	SCRW SM PLT 6 X 3/8 PHL	260Z
33	2T-30401-29	1	STAT FXD 435 DEG OPEN	260Z
34	2A-W1185	5	ORIFICE FITTING - 90 DEG	260Z
35	K9-141-150	5	BURNRER GROUND BRACKET	260Z
37	K9-141-145	5	VIEW PORT COVER	260Z
38	2E-80302-10	2	DSI PROBE LEFT 141	260Z
39	2E-80302-11	3	DSI PROBE RIGHT 141	260Z
40	PS-JIB-SEN-ENV	5	KIT, PROBE ENVIROZONE GG	260Z
41	K9-141-171-1	5	BURNER ASSY	260Z
42	2C-20307-02	5	NUT - NYLON 5/16 - 18	260Z
NI	2A-80400-32	5	ORIFICE HOOD UNDRILLED	260Z
NI	2E-31107-02	1	CORD SET 14/3 X 8' 15A	260Z
NI	2E-Z9592	1	SWITCH, ROCKER	260ZHE
NI	2K-70104-02	5	FLEXIBLE TUBE 3/8OD X 10	260Z
NI	2K-70104-03	4	FLEXIBLE TUBE 3/8OD X 8	260Z
NI	2K-70104-04	1	FLEXIBLE TUBE 3/8OD X 12	260Z
NI	Y9-80400-11	5	ORIFICE HOOD .0935 # 42	260Z



# PARTS LIST

October 12, 2011, Rev F

## Model No: 272Z-NAT, 272Z-NATJB, 272Z-NATJBM, 272ZB-NATLH, 272Z-LPJB, 272Z-LPJBT ChefSeries Gas EnvioZone Griddle

Key Number	Part Number	Qty Per	Description	
1	K9-141-201-6	1	PLATE ASSY - 6'	272Z
1	K9-141-201-62	1	PLATE ASSY - 6' W/XLH12	272ZHE
1	K9-141-433-6	1	PLATE ASY 6' REAR	272ZB-NATLH
2	2A-72500-20	4	LEG 10.25 WITH ADJ HEX	272Z-LPJB
2	2A-72901-34	4	LEG STD 2 OD X 24.625	272Z-NATJBM
2	K9-141-115	4	LEG STD 2 OD X 24.625	272Z-LPJBT
3	2P-72901-33	4	CSTR 5 ADJ FOR 72901-34	272Z-LPJBT, 272Z-NATJBT
4	K9-141-231-6	1	CONTROL PANEL ASSY - 6'	272Z
4	K9-141-231-6-W1	1	CNTR PNL ASSY-6' W/SWITCH	272ZHE
5	2C-20301-10	4	NUT HEX 6-32 PLTD	272Z
6	2C-20205-02	4	.140#6IDX.2500DX.032	272Z
7	2A-20504-07	4	SPACER #6 1/4 X 13/16	272Z
8	2M-60301-153	1	LABEL PANEL 141 GRIDDLE	272Z
9	K9-141-236-02	1	CONTROL PANEL 4' & 6'	272Z
10	K9-141-232	1	CONTROL RECESS ASSY	272Z
10	K9-141-232-W1	1	CTRL RECESS ASSY-W/SWITCH	272ZHE
11	K9-40102-61	1	GRIDDLE CONTROL-SAGE	272Z
12	2J-40102-61-1	1	DISPLAY FOR GG & GE	272Z
13	2K-70801-33	4	SPACER SUPPORT NYLON	272Z
14	2J-40102-61-4	1	GRIDDLE CTRL-GG MAIN BD	272Z
15	K9-141-245-6	1	FRONT PANEL RH ASSY 6'	272Z
16	K9-141-241-6	1	FRONT PANEL LH ASSY 6'	272Z
17	K9-141-251	2	GREASE DRAWER ASSY	272Z
17	K9-141-437	2	GREASE DRAWER ASSY - REAR GTR	272ZB-NATLH
18	K9-141-181	6	BAFFLE UNDER BURNER	272Z
19	K9-141-182	3	BAFFLE BETWEEN BURNERS	272Z
20	2V-80501-04	1	GAS REG 3/4X3/4 CLS I	272Z
20	2V-80501-05	1	GAS REG 3/4X3/4 CLS II	272Z-LPJB
21	K9-141-157-6	1	MANIFOLD ASSY - 6'	272Z
22	K9-141-156-3	6	VALVE SHIELD	272Z
23	2V-80502-04	6	SOLENOID VALVE 120VAC 1/2PIPE	272Z
24	K9-141-156-1	6	VALVE MOUNT BASE	272Z
25	K9-141-156-2	6	VALVE MOUNT FRONT FLANGE	272Z
26	2K-70101-11	12	BRAS TBE UNON 3/8CC-1/2	272Z
27	2C-20102-12	12	SCRW PHD ST 10-32X3/8 PLTD T23	272Z
28	K9-141-152	6	SPARK MODULE MOUNT	272Z
29	2C-20102-04	12	SCRW PHD ST 8-32X.5 PLTD	272Z
30	2J-80300-17	6	SPRK IGN CNTRL 141	272Z
31	K9-141-146	6	PROBE GUARD SUPPORT	272Z
32	2C-20103-06	2	SCRW SM PLT 6 X 3/8 PHL	272Z
33	2T-30401-29	1	STAT FXD 435 DEG OPEN	272Z
34	2A-W1185	6	ORIFICE FITTING - 90 DEG	272Z
35	K9-141-150	6	BURNRER GROUND BRACKET	272Z
37	K9-141-145	6	VIEW PORT COVER	272Z
38	2E-80302-10	3	DSI PROBE LEFT 141	272Z; ZONE: 1, 3, 5
39	2E-80302-11	3	DSI PROBE RIGHT 141	272Z; ZONE: 2, 4, 6
40	PS-JIB-SEN-ENV	6	KIT, PROBE ENVIROZONE GG	272Z
41	K9-141-171-1	6	BURNER ASSY W/#80002-15-2	272Z
42	2C-20307-02	6	NUT - NYLON 5/16 - 18	272Z
NI	2A-80400-32	6	ORIFICE HOOD UNDRILLED	272Z
NI	2E-31107-02	1	CORD SET 14/3 X 8' 15A	272Z
NI	2E-Z9592	1	SWITCH, ROCKER	272ZHE
NI	2K-70104-02	6	FLEXIBLE TUBE 3/8OD X 10	272Z
NI	2K-70104-03	6	FLEXIBLE TUBE 3/8OD X 8	272Z
NI	K9-141-800-6	1	SHELF MAIN ASSY 6'	272Z-LPJBT, 272Z-NATJBM, 272Z-NATJBT
NI	K9-72901-321	4	LEG PAD ASSY 2 BOLT ON	272Z-NATJBM
NI	Y9-80400-11	6	ORIFICE HOOD .0935 # 42	272Z-NAT
NI	Y9-80400-12	6	ORIFICE HOOD .0595 #53	272Z-LPJB

Some items are included for illustrative purposes only and in certain instances may not be available.



# WIRING DIAGRAM

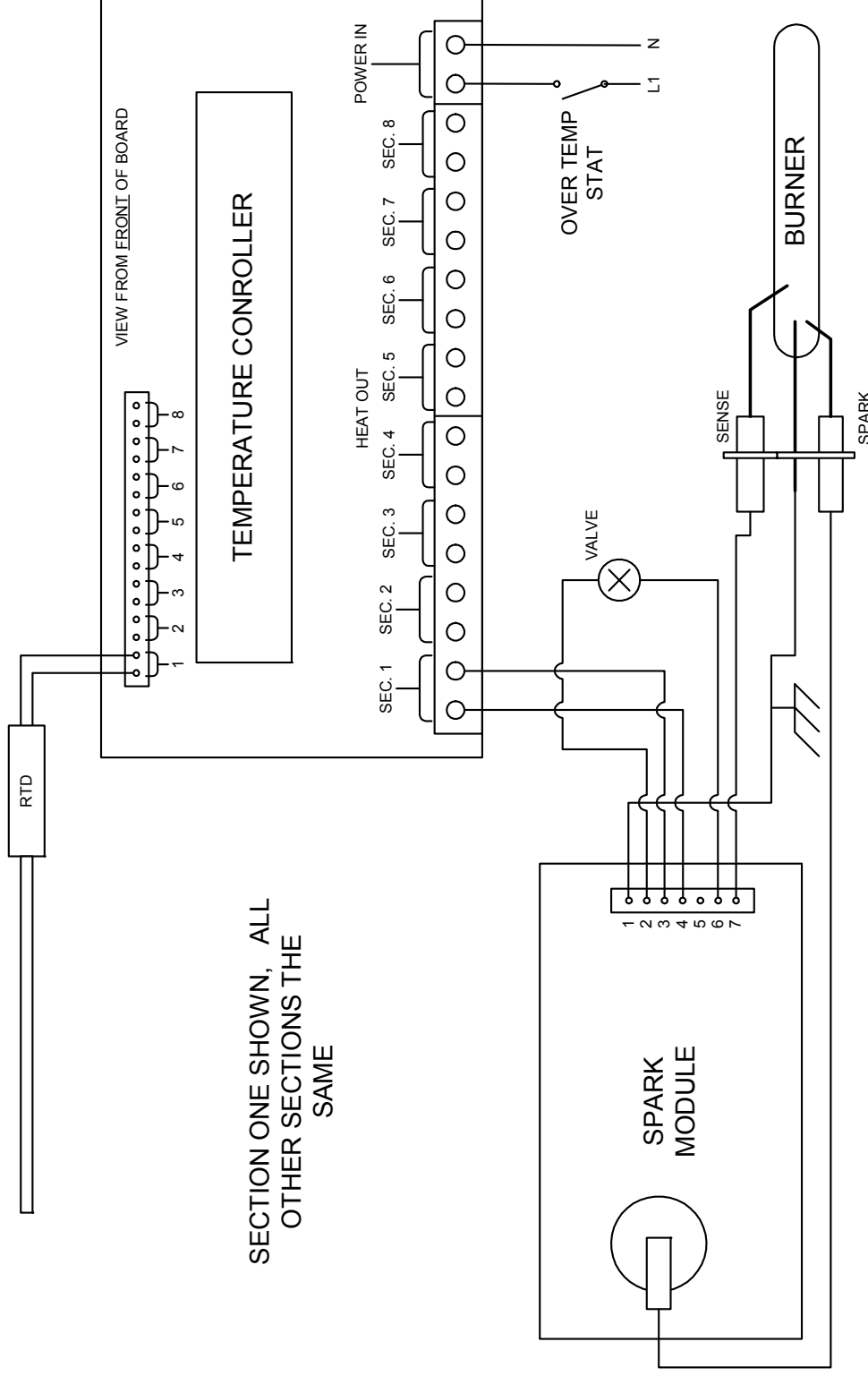

SECTION ONE SHOWN, ALL  
OTHER SECTIONS THE  
SAME