

OWNER'S MANUAL

COOK AND CHILL DIRECT STEAM TILTING KETTLE

MODELS:

CCT-20L
CCT-30L
CCT-40L
CCT-60L
CCT-80L



PRINTED IN U.S.A.

S-2316 REV. A 06/06

MARKET FORGE IND., INC

35 GARVEY STREET, EVERETT, MA 02149-4403

TELEPHONE: (617) 387-4100, FAX: (617) 387-4456

TOLL FREE: (866) 698-3188, OUTSIDE MA FAX: (800) 227-2659

CUSTSERV@MFII.COM, WWW.MFII.COM

IMPORTANT NOTES FOR INSTALLATION AND OPERATION



This is the safety alert symbol. It is used to alert you to potential personal injury hazards. Obey all safety messages that follow this symbol to avoid possible injury or death.



WARNING: Improper installation, operation, adjustment, alteration, service or maintenance can cause property damage, injury or death. Read the installation, operating and maintenance instructions thoroughly before installing, operating or servicing this equipment.

Do not attempt to operate this unit in the event of a power failure.

Adequate clearances must be maintained for safe operation and servicing.

Intended for commercial use only. Not for household use.

NOTICE: Contact the factory, the factory representative or local service company to perform maintenance and repairs.





This manual should be retained for future reference.

INSTALLATION AND OPERATION MANUAL,
DIRECT STEAM KETTLES-TILTING COOK AND CHILL KETTLES

TABLE OF CONTENTS

DESCRIPTION	PAGE
Important Notes for Installation and Operation	2
Service Connections	4
1.0 Introduction	5
2.0 Installation Instructions	6
3.0 Operating Instructions	8
4.0 Cleaning Instructions	9
5.0 Maintenance	13
6.0 Troubleshooting	14

SERVICE CONNECTIONS

-  - STEAM SUPPLY: 3/4"IPS. *
 - CONDENSATE RETURN: 1/2"IPS.
 - COLD WATER: 3/8" O.D. tubing to faucet (OPTIONAL)
 - COLD WATER IN: 1/2" IPS for Quick Chilled System.
 - COLD WATER OUT: 1/2" IPS for Quick Chilled System.

DIMENSIONS

MODEL	CAPACITY	UNITS	A	B	C	D	E	F	G	H	J
DLT-20TC	20 gallons	inches	21	46	18	2.5	32.5	12.38	14.75	36.88	63.13
	76 litres	mm	533	1168	457	64	825	314	375	937	1603
DLT-30TC	30 gallons	inches	24	49	20	3	32.5	13.13	13.25	38.63	66.5
	114 litres	mm	610	1245	508	76	825	333	337	981	1689
DLT-40-TC	40 gallons	inches	26	51.13	22.5	4.5	32.5	13.88	12.38	39.5	69.88
	152 litres	mm	660	1299	572	114	825	352	314	1003	1775
DLT-60TC	60 gallons	inches	29.5	54.38	26	6.5	34.5	15.38	12.63	41.13	77.13
	227 litres	mm	749	1381	660	165	876	391	321	1045	1959
DLT-80TC	80 gallons	inches	33	57.88	28	6.88	36.25	17.13	12.5	43.25	82.25
	303 litres	mm	838	1470	711	175	921	435	318	1099	2089
DLT-100TC	100 gallons	inches	35.5	60.5	30	6.63	38.38	16.63	12.5	44.63	86.75
	379 litres	mm	902	1537	762	168	975	422	318	1133	2203

* Pressure reducing valve is required if incoming pressure exceeds 50 PSI(345 kPa).

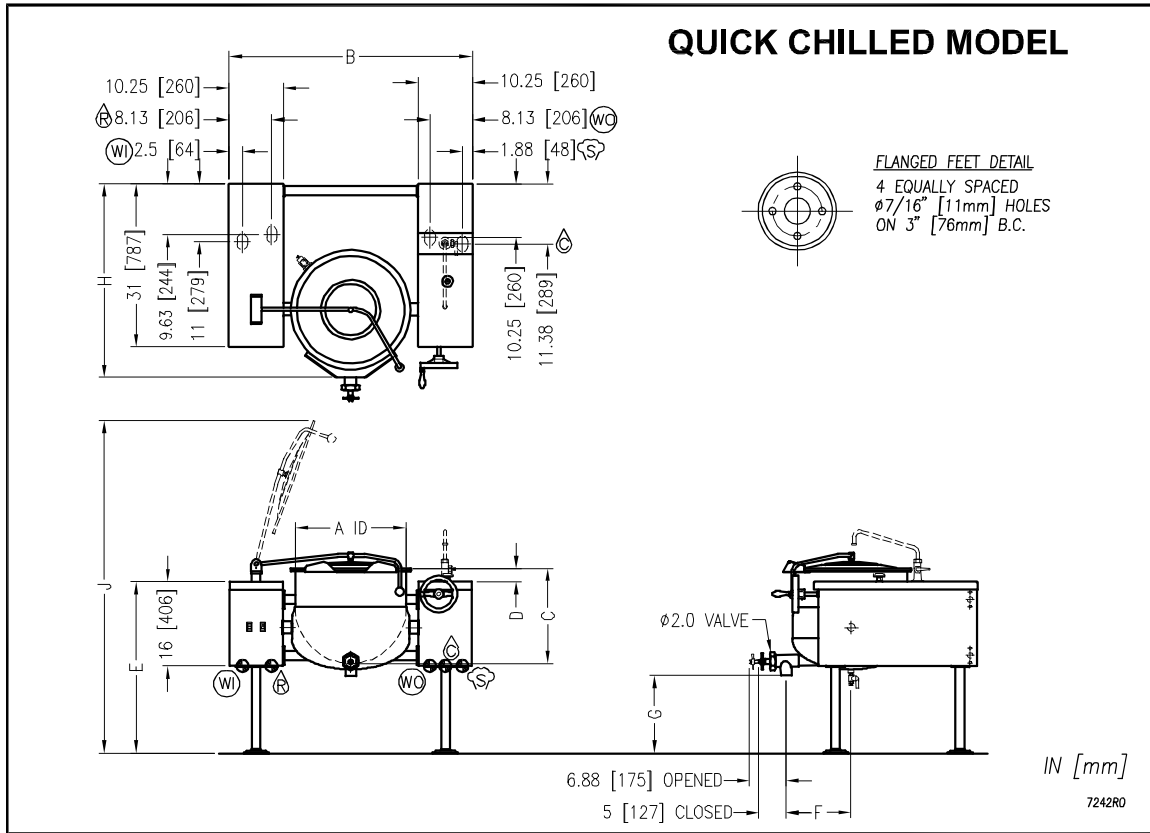

As continued product improvement is a policy of Crown, specifications are subject to change without notice.

1.0 INTRODUCTION

DESCRIPTION

All Crown direct connected steam jacketed kettles pertaining to this manual are direct steam operated pressure vessels of a double-wall stainless steel construction forming a steam chamber (jacket) enveloping the lower two thirds of the kettle bowl surface. All kettles are equipped with a drain cock, safety relief valve and a steam control valve. Options on kettles are hinged spring assisted stainless steel lid covering the kettle bowl opening and a sanitary stainless steel tangent draw-off valve as an alternate method for the removal of the food product from the kettle bowl.

CAPACITIES

All models are suffixed with either - 20, - 30, - 40, - 60, - 80 or - 100 to indicate the capacity of that kettle in U.S. gallons. Thus a DLT-40 is a two thirds jacketed direct steam kettle mounted on legs with a capacity of 40 gallons (U.S.). If the letter F is added to the suffix, this then indicates that the kettle is full jacketed direct steam kettle mounted on a pedestal with a capacity of 40 gallons (U.S.).

FUNCTIONING MODE

The kettle bowl is the container for the food product which ideally should be of a liquid or semi-liquid consistency to achieve complete contact with the bowl surface and thus fully absorb the heat transmitted through the surface.

The temperature required for the cooking process to function adequately must be greater than the boiling point of the liquid food product. Further, the greater the steam pressure used, the higher the temperature and consequently the quicker the cooking process. For example, steam pressurized at 30 p.s.i. attains a temperature of 274 degrees Fahrenheit (135 degrees Celsius).

2.0 INSTALLATION INSTRUCTIONS

UNPACKING

Immediately after unpacking, check for possible shipping damage. If the kettle is found to be damaged, save the packaging material and contact the carrier within 15 days of delivery.

Before installing, verify that the electrical service agrees with the specifications on the rating plate located on the right side of the tilt console. If the supply and equipment requirements do not agree, contact your dealer or Crown Food Service Equipment Ltd.

Select a location with drainage directly below the tangent draw-off. Allow sufficient rear clearance from wall for kettle cover to lift upright freely and completely without obstructions.

INSTALLATION

1. The kettle must be installed in accordance with:
 1. State and/or local codes.
 2. In the USA, the National Electrical Code, ANSI/NFPA-70 (latest edition). In Canada, the Canadian Electrical Code, Part 1, CSA Standard C22.1 (latest edition).
2. Set the kettle in the installation location.
3. With the kettle in the upright position, place a carpenter's level on top of the kettle and turn the adjustable feet to level kettle side-to-side and front to back.
4. Mark hole locations on floor through anchoring holes provided in flanged adjustable feet.
5. Remove kettle and drill holes in locations marked on the floor (see installation diagram). Insert proper anchoring devices to accommodate 5/16" size lag bolts (not supplied).
6. Reposition kettle. Re-level kettle by making necessary adjustments on flanged feet.
7. Bolt down kettle and seal with Silastic or other equivalent sealing compound. Sealant must be applied not only to bolt heads but also around flanges or pedestal base making contact with floor surface to fulfill NSF requirements. Wipe off excess sealant immediately.

2.0 INSTALLATION INSTRUCTIONS (Continued)

8. Connect steam line (3/4" pipe size) to the kettle, making sure there is steam control valve strainer fairly convenient to the kettle. If incoming steam pressure is greater than kettle maximum operating pressure, a pressure reducer valve **must** be installed in the line. A steam line pressure gauge is recommended to determine amount of actual steam coming to the unit. Safety relief valve **must not** be plugged as it relieves excess pressure in the kettle.
9. Connect water line (1/2" pipe size) to appliance as shown in service connections.
10. Connect kettle condensate return line and water return line to drain or boiler return line. Boiler return line must have a check valve.
11. Check for proper operation.

3.0 OPERATING INSTRUCTIONS

Appliance is equipped with a power switch and a cook/chill switch which operates valves for the steam supply and water supply to the kettle jacket. In order to operate the kettle for cook/chill the power switch must be turned on.

COOKING CYCLE:

1. If kettle has draw-off valve, close it.
2. Close drain cock valve at bottom of kettle.
3. Fill kettle with product to desired level.
4. Turn power switch "ON" (Figure 1).
5. The operating switch has two positions (Figure 2). Set switch to "COOK". Steam will enter the kettle jacket and cooking will commence.
6. Turn steam control valve on fully. Cooking may be regulated by closing the steam control valve to the desired cooking temperatures.

CHILL CYCLE:

1. Set operating switch to "CHILL". Continuous cold water will circulate through the kettle jacket. Maintain surveillance that the proper amount of cooling has occurred.
2. Once chilled to the desired temperature set power switch to "OFF". Neither water or steam will enter the kettle jacket.
3. Open drain cock valve and allow water to drain from kettle jacket.
4. Remove product from kettle.
5. Clean kettle as per cleaning instructions.

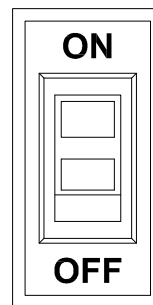

Figure 1

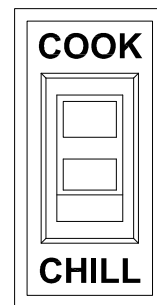

Figure 2

4.0 CLEANING INSTRUCTIONS



WARNING: Disconnect the power supply to the appliance before cleaning or servicing.



WARNING: Never spray water into electric controls or components!



CAUTION: The equipment and its parts are hot. Use care when operating, cleaning and servicing.



CAUTION: Do not use cleaning agents that are corrosive.

Your kettle should be cleaned immediately after each use or when cooking a different product. Before cleaning, check that the kettle has cooled enough to touch it.

1. Rinse the inside of the kettle thoroughly and drain to remove any food particles.
2. Using a nylon brush, clean the kettle with a mild detergent and water. Never use steel wool or scouring powder as it will scratch stainless steel. Plain steel wool can leave small pieces of steel which can rust.
3. Rinse the inside of the kettle thoroughly with clean water. **Drain the kettle by tilting or the tangent draw-off valve, depending on model**, to allow the detergent and water solution to drain.
4. Wipe exterior of the kettle with a clean, damp cloth.



WARNING: If you are cleaning a valve that is assembled to a kettle, be sure the kettle is completely empty of any product.

4.0 CLEANING INSTRUCTIONS (Continued)

DRAW-OFF VALVE CLEANING

1. If equipped with a tangent draw-off valve, turn the large hex nut on the draw-off valve counterclockwise until it is completely disengaged from the threads. Grasp the valve knob and slowly pull out the valve stem. Wash the valve stem, disk and handle. Insert a nylon brush, wet with detergent and water, into the valve body and tangent draw-off tube. Brush vigorously.
2. Replace the valve stem assembly and turn the hex nut until snug. Rinse the kettle with clean warm water.
3. Leave the draw-off valve open when the kettle is not in use.

DAIRY DRAW-OFF VALVE CLEANING

1. Remove the plug by first removing the handle, then turn the plug to line up with the pin and pull with both hands. It is important to use both hands because the plug is heavy.
2. Put the plug in a plastic pail that contains a mild soap solution. A plastic pail works best, as it reduces the possibility of nicking or scratching the plug. If the plug gets scratched it may not seal correctly and could leak.
3. Use a soft cloth or soft brush and clean all surfaces.
4. Using both hands remove the valve from the soap and rinse well in another plastic pail that contains fresh water.
5. Wash out the kettle as normal.
6. Once the kettle is washed out, return the plug into the body. Be sure the plug is inserted into the notch and turned. Ensure the plug is tight and secure before letting go of it.

If you are cleaning a body and plug assembly, remove the plug and follow the above procedures. When finished with the plug, follow the same instructions for washing the body. Always use both hands when handling the plugs. Reassemble the plug into the body and use as normal.

4.0 CLEANING INSTRUCTIONS (Continued)

WHAT TO DO IF SURFACE RUST APPEARS

Metal utensils should never be used as they will scratch the surface of the equipment and rust may begin to form. To remove surface accumulation of rust from the inadvertent use of such utensils, the following procedure may be used.



CAUTION: Improper use of this procedure may damage your appliance!

1. Use undiluted white vinegar with a non-abrasive scouring pad (plastic) or cloth on the affected area to remove the rust stain. The appliance should not be heated and remain at room temperature during the entire cleaning process.
2. If the stain resists removal, additional exposure time with vinegar may be required, to a maximum of one hour.
3. Thoroughly wash all of the vinegar away with fresh clear water. Dry the surface completely and allow one hour before using the appliance to cook.

Following daily and period maintenance procedures will prolong the life of your equipment. Climatic conditions - salt air - may require more thorough and frequent cleaning or the life of the equipment could be adversely affected.

4.0 CLEANING INSTRUCTIONS (Continued)

STAINLESS STEEL

To remove normal dirt, grease or product residue from stainless steel, use ordinary soap and water (with or without detergent) applied with a sponge or cloth. Dry thoroughly with a clean cloth. Never use vinegar or any other corrosive cleaner.

To remove grease and food splatters or condensed vapours that have baked on the equipment, apply cleanser to a damp cloth or sponge and rub cleanser on the metal in the direction of the polishing lines. Rubbing cleanser as gently as possible in the direction of the polished lines will not mar the finish of the stainless steel. **NEVER RUB WITH A CIRCULAR MOTION.**

Soil and burn deposits which do not respond to the above procedure can usually be removed by rubbing the surface with **SCOTCH-BRITE™** scouring pads or **STAINLESS** scouring pads. **DO NOT USE ORDINARY STEEL WOOL** as any particles left on the surface will rust and further spoil the appearance of the finish. **NEVER USE A WIRE BRUSH, STEEL SCOURING PADS (EXCEPT STAINLESS), SCRAPER, FILE OR OTHER STEEL TOOLS.** Surfaces which are marred collect dirt more rapidly and become more difficult to clean. Marring also increases the possibility of corrosive attack. Refinishing may then be required.

TO REMOVE HEAT TINT: Darkened areas sometimes appear on stainless steel surfaces where the area has been subjected to excessive heat. These darkened areas are caused by thickening of the protective surface of the stainless steel and is not harmful. Heat tint can normally be removed by the foregoing, but tint which does not respond to this procedure calls for a vigorous scouring in the direction of the polish lines using **SCOTCH-BRITE™** scouring pads or a **STAINLESS** scouring pad in combination with a powdered cleanser. Heat tint action may be lessened by not applying or by reducing heat to equipment during slack periods.

All food contact surfaces must be thoroughly drained and flushed prior to cooking in the kettle.

5.0 MAINTENANCE

PREVENTIVE MAINTENANCE

No preventive maintenance is required other than adhering to the Cleaning Procedure instructions.

6.0 TROUBLESHOOTING

DRAW-OFF VALVE LEAKS

If a leak occurs through the valve stem, replace the "O" ring. Leaks may also be caused by damaged rubber vulcanized stem piece. If the stem piece is damaged, it must be replaced.

NOTICE: Draw-off valve has a vulcanized rubber coated stem for better sealing. Do not over tighten. This may cause the rubber to pull away from stem and permanently damage it. This is not covered under warranty.



WARNING: If you are cleaning a valve that is assembled to a kettle, be sure the kettle is completely empty of any product.

EXTREMELY SLOW COOKING TIME

If the cooking time is abnormally slow then the difficulty may be due to insufficient steam pressure and/or volume. First determine that pressure on incoming steam line at kettle is within 5 p.s.i. of rated kettle pressure. Note that pressures approaching the rated kettle pressure are liable to set off the safety relief valve. If required pressure is available to kettle, then possibly volume of steam is not sufficient. Minimum 3/4" pipe size is required to the kettle but if the steam generating source is at a great distance from the kettle, larger pipe will be required. Finally, the core of the steam supply pipe may have debris or scalants that impede steam flow and will require disassembly and inspection.

6.0 TROUBLESHOOTING (Continued)

AIR VENTING

The thermostatic trap is a mechanical device that closes on high temperature and opens when the temperature drops, allowing water which formed from condensate to exhaust but retain steam under pressure.

The temperatures required for the cooking process to function adequately must be greater than the boiling point of the liquid food product. The greater the steam pressure used, the higher the temperature and the quicker the cooking process. For example, steam pressurized at 30 p.s.i. reaches a temperature of 274 degrees Fahrenheit (135 degrees Celsius). Since air is an unsuitable media through which heat may be transferred, the air should be exhausted from the jacket by opening the pressure relief valve until the air has been completely replaced by pressurized steam.

In the initial stages of the cooking process when the steam comes in contact with the cold kettle bowl surface, it condenses and forms a large amount of water. The condensate water must be removed from the kettle jacket in order for the kettle to function adequately. The ball valve located at the base of the kettle jacket may be opened to remove the water. It may be necessary to repeat this procedure several times depending on the number of batches being cooked as each batch will create condensate. If the kettle appears to be slow in heating, this would indicate that there is water in the jacket. Open ball valve and drain. Close valve and commence operation of kettle.