

# Salvajor Model 100 1 HP - 1 Phase

## Series J Disposer Parts Breakdown

For Serial Numbers starting at:  
115/230V - 15296 208V - 8802

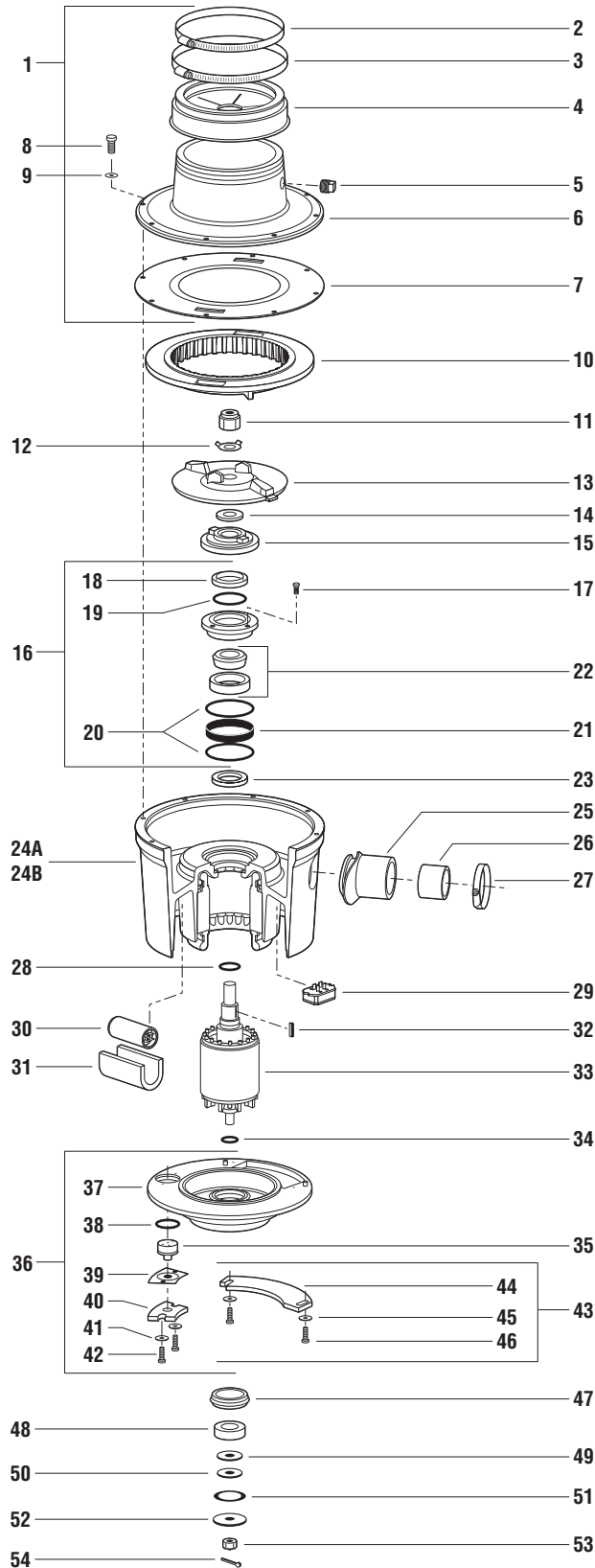

NO.	PART NO.	DESCRIPTION
1	980131	TOP HOUSING ASSY (includes 2 thru 7)
2	M116	CLAMP
3	M128	CLAMP
4	2357A	HYCAR ADAPTOR
5	PL5	PLUG 1/2" PLASTIC
6	983010	TOP HOUSING
7	996045	CENTER GASKET (S)(C)
8	997022	SCREW 5/16-18 X 1" HHCAP
9	997123	WASHER FLAT 11/32 x 5/8OD SS
10	8SWX	SHREDDER (C)
11	7814RN	ROTOR NUT (S)(C)
12	997092	LOCK WASHER (S)(C)
13	983015	FACE PLATE (C)
14	996025	ROTOR SHAFT GASKET (S)(C)
15	980132	ROTOR BASE (S)(C)
16	980007	TOP END BELL ASSY (S) (includes 17 thru 21)
17	997066	SCREW 10-32 X 5/8" (S)
18	S67350B	VARILIP SEAL (S)
19	995009	SPACER SEAL TEB (S)
20	12151	O-RING (S)
21	ANL79X15S	TOLERANCE RING (S)
22	985001	BEARING CUP/CONE TOP (S)
23	S67350	VARILIP SEAL (S)
24A	MH21004	HOUSING W/STATOR 1HP 115/230V 1-PH
24B	MH21005	HOUSING W/STATOR 1HP 208V 1-PH
25	RDO	DRAIN OUTLET 2"
26	DI	DRAIN INSERT 2"
27	M40	CLAMP DISPOSER 2"
28	11026	O-RING (S)
29	994071	START SWITCH 1PH
30	994183	CAPACITOR
31	996055	CAPACITOR HOLDER
32	31634	KEY 3/16 x 3/16 x 3/4" (S)
33	991105	MOTOR ROTOR 100-1
34	996020	O-RING (S)
35	KL1001	KLIXON
36	BEBA123G	BOTTOM END BELL ASSY (includes 37 thru 43)
37	983016	BOTTOM END BELL
38	123	KLIXON O-RING (S)
39	KLCG	KLIXON COVER GASKET
40	KLC	KLIXON COVER
41	997043	WASHER 10-32
42	997067	SCREW 10-32 X 3/4"
43	JBCA	JUNCTION BOX COVER ASSY (includes 44,45,46)
44	JBC	JUNCTION BOX COVER
45	997024	WASHER 3/4" OD 3/16" ID
46	997067	SCREW 10-32 X 3/4"
47	996023	BEB RUBBER ISOLATOR (S)
48	6205	BOTTOM BEARING (S)
49	987002	DRIVE WASHER (S)
50	996024	FRICTION WASHER (S)
51	987003	WAVE WASHER (S)
52	987001	RETAINING WASHER (S)
53	997050	CASTLE NUT (S)
54	997051	COTTER PIN (S)

### SEAL AND CUTTING KITS

KSH123	Seal Kit (All Models)
KCJ1	Cutting Kit (Model 75-125)

(S) Designates Parts included in Seal Kit (C) Designates Parts included in Cutting Kit



**The Salvajor Company**

4530 East 75th Terrace  
Kansas City, MO 64132-2081 USA

CALL FREE: 1-888-SALVAJOR FAX FREE: 1-800-832-9373

SPECIFY VOLTAGE AND PHASE WHEN ORDERING