



Quality Refrigeration

OWNER'S MANUAL

**Instructions for the installation, operation,
and maintenance of Blast Chiller Models:**

**RBC50 (50 lb. capacity undercounter model)
RBC100 (100 lb. capacity reach-in model)
RBC200 (200 lb. capacity roll-in model)
RBC200RT (200 lb. capacity roll-thru model)
RBC400 (400 lb. capacity roll-in model)
RBC400RT (400 lb. capacity roll-thru model)**

This Traulsen unit is built to our highest quality standards. We build our refrigerators, freezers, blast chillers and heated cabinets this way as a matter of pride. This philosophy has made Traulsen the leader in commercial refrigeration since 1938. We thank you for your choice and confidence in Traulsen equipment and we know you will receive many years of utility from this equipment.

All Traulsen units are placed on a permanent record file with the service department. In the event of any future questions you may have, please refer to the model and serial number found on the name tag affixed to the unit. Should you need service, however, call us on our toll free number, 800-825-8220 between 7:30 am and 4:30 pm CST, Monday thru Friday. It is our pleasure to help and assist you in every possible way.

IMPORTANT WARRANTY NOTES

RBC50 & RBC100 Owner/Operators

Please Contact (800) 825-8220 ext. #6115 upon start-up to register your warranty

RB200/RBC200RT & RBC400/RBC400RT Owner/Operators

Please Contact (800) 825-8220 ext. #6112 after installation but before start-up in order to register your warranty and arrange for a mandatory free Installation Validation & Service Check (allow at least 72 hours from time of call for this to be performed)

Contact your local Hobart/Traulsen sales representative to arrange for a free on-site demonstration (after warranty registration and/or installation validation)

I. INTRODUCTION

Thank you for your decision to purchase a Traulsen Blast Chiller. This important piece of food safety equipment is built to our highest standards and will provide you with years of dependable service. However, it is important to note that although this product is designed to chill product from 135°F down to below 41°F within FDA/HACCP guidelines, several operational factors, such as product temperature, density, loading, etc. will all effect actual chilling performance. As a result, although easy to use, the operation of blast chilling requires diligent attention on the part of the operator(s) in order to insure proper results.

It is also important to note many perceived service problems can actually be attributed to operational issues, resulting in lost product and/or service down time. Please review the instructions contained in this manual completely, and make certain that all operators are well trained in the equipments proper use.

TABLE OF CONTENTS

GETTING STARTED: QUICK START CHECK-LISTS & GUIDELINES

Blast Chiller Installation Checklist	Page 2
Blast Chiller Quick Start Checklist	Page 3
Basic Operating Guidelines	Page 4

SECTION 1: RECEIPT, INSTALLATION, CARE & MAINTENANCE

I. Introduction	Page 1
II. Receipt Inspection	Page 5
III. Installation	
a-Location	Page 5
b-Packaging	Page 5
c-Wiring Diagram	Page 5
d-Installing Legs or Casters	Page 5
e-Assembly Of Models RBC400 & RBC400RT	Page 5
f-Cord & Plug	Page 6
g-Electrical Requirements	Page 6
h-Proper Clearances	Page 6
i-Condensate Removal	Page 7
j-Remote Unit BTU Requirements	Page 7
k-Remote Unit Cut-Out Settings	Page 7
l-Sealing Roll-In/Roll-Thru Units	Page 7
m-ON/OFF Power Switch	Page 7.
n-Installing RBC50 Control Panel	Page 8
IV. Care & Maintenance	
a-Cleaning The Condenser	Page 8
b-Printer Supplies	Page 8
c-Installing Printer Paper	Page 8/9
d-Cleaning The Exterior	Page 9
e-Cleaning The Interior	Page 9
f-The Serial Tag	Page 9
V. Other	
a-Service Agency Check & Start-Up	Page 9
b-On-Site Blast Chill Training	Page 9
c-Service Information	Page 9
d-Demonstrations	Page 9
e-Blast Chill Video	Page 9
f-Blast Chill Data Communications Kit	Page 9

SECTION 2: CONTROL OPERATION DETAILS

VI. The SmartChill® Control	
a-The SmartChill Control - Overview	Page 10
b-Printing Capability	Page 10
c-Control Basics	Page 10
d-Start-Up	Page 10
e-Over Temperature	Page 10
f-In The Event Of A Power Interruption	Page 10
g-Getting Started	Page 10
h-EZ Start	Page 10
VII. Operating The Blast Chill Control	
a-Starting A Chill Cycle By Temp	Page 11-12
b-Starting A Chill Cycle By Time	Page 13
c-Starting A Chill Cycle By Product	Page 14
d-Chill By Product Feature - Product List	Page 15
e-Refrigerated Hold Mode	Page 16
f-Starting A Manual Defrost	Page 16
g-Printing Batch/Chill Cycle Data	Page 17
h-Set-Up Products	Page 18
i-Set-Up Users	Page 19
j-Accessing The SYSPAR	Page 20
k-SYS PAR	Page 21

SECTION 3: OTHER/MISC.

VIII. SmartChill® Communications	
a-Introduction	Page 22
b-System Requirements	Page 22
c-Operation	Page 22
d-Communicating With SmartChill	Page 22
e-Hardware Connection	Page 22
IX. Glossary	Page 23
X. Replacement Parts List	Page 24
XI. Summary of Error Messages	Page 25
XII. Warranty Information	Page 26
XIII. Mechanical Trouble Shooting Guide	Back Cover

Blast Chiller Installation Checklist

Model RBC50

- 1) Insure proper clearances, no obstruction to either front louver for at least 24" from cabinet face.
- 2) Install all four standard legs or optional casters, insuring that the unit is level for proper operation (see section III d. for more details).
- 3) Install the control panel (see section III n. for more details). Before doing so be sure to perform a visual inspection of the control to insure that no connections have come loose during shipment.
- 4) Plug both power cords into separate, dedicated 115 volt/20 amp outlets (see section III f. for more details).
- 5) Insure that paper supply for both printers are properly installed and that the printers themselves are operational (see section IV c. for more details).

Model RBC100

- 1) Insure proper clearances, no obstruction to either front louver for at least 24" from cabinet face, 6" along left side, 4" along the right side, and 6" behind the unit
- 2) Install the legs or casters, insuring that the unit is level for proper operation (see section III d. for more details).
- 3) Make condensate removal provisions (see section III h. for more details).
- 4) Hardwire the cord to a dedicated 220/60/1 volt, 4 wire, 20 amp circuit (see section III g. for more details).
- 5) Insure that paper supply for both printers are properly installed and that the printers themselves are operational (see section IV c. for more details).

Models RBC200 & RBC200RT (same for models RBC400 & RBC400RT but please see section III e. for additional installation/assembly instructions)

- 1) Insure proper clearances, no obstruction to either front louver for at least 12" above the cabinet and 4" along the right side (for the drain tube). Unit must be located on a level surface.
- 2) Seal the unit to the floor (see section III l for more details).
- 3) Install the door ramp(s), (see section III i. for more details).
- 4) Make condensate removal provisions (see section III h. for more details). Note that two drain outlets are provided. Please insure that the unused drain line is properly plugged to prevent leaks.
- 5) Plug the power cord into a dedicated 115 volt/20 amp outlets (see section III g. for more details).

IMPORTANT NOTE

In order to accomplish blast chilling, models RBC200 and RBC200RT require one, and models RBC400 and RBC400RT require two properly sized remote condensing units (see section III j. for more details). After this installation has been completed by a qualified refrigeration technician, please call Traulsen Service at (800) 825-8220 in order to arrange for your free on-site installation validation.

- 6) In order to properly charge the system, at the completion of installation this must be run in blast chill mode for at least 90-minutes. To do so...

- 1- Select: BY TIME from the main menu.
- 2- Then select the default setting CHILL (default) or scroll up or down to select this mode.
- 3- Next select the default cycle time 01:30 (1 hour & 30 minutes) or scroll up or down to select this time.
- 4- Finish by selecting START to initiate the test cycle.

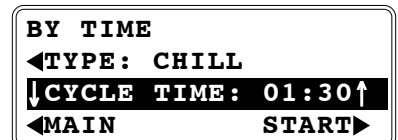
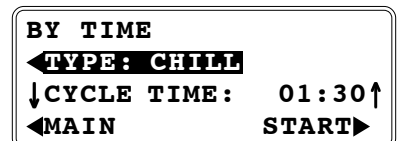
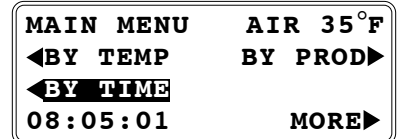

- 7) Insure that paper supply for both printers are properly installed and that the printers themselves are operational (see section IV d. for more details).

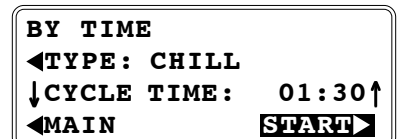

GENERAL NOTE:

In the event that the owner's manual is not available, please visit www.traulsen.com in order to view/print the latest version.

Blast Chiller Quick Start Checklist



Starting a Chill Cycle - All Models

- 1) Load product into the blast chiller. Both full and partial loads are OK, but for best results evenly distribute product throughout the interior tray slides or roll-in rack.
- 2) Insert a food probe into the top, bottom and middle level pans. The probe should be located in the center of the food pan, at about the halfway point of the product depth.
- 3) Close the door.
- 4) Press the EZ Start button.

The Blast Chill Process - All Models

- 1) While in a blast chill cycle, cold air is rapidly being circulated around the food pans in order to remove heat as rapidly as possible.
- 2) Actual chill times will vary depending on many product related factors such as starting temperature, product density, cycle load, content, etc.
- 3) To insure food safety, the probes constantly monitor product core temperature(s) throughout each chill cycle, as well as during any holding period afterwards. Reports available at the end of each chill cycle can then be used by the operator to confirm that both FDA critical control points were met in accordance with the current food code.



Concluding a Chill Cycle - All Models

- 1) Upon each probe reaching target temperature (37°F) an audible alarm will sound for 30-seconds, and the probe number on the control display will continuously flash "DONE."
- 2) Press the button alongside the probe flashing "DONE" in order to conclude that probe's batch.
- 3) The control will now display the print menu.
 - 3a. Press BOTH to receive both record and label printouts
 - 3b. Press RECORD to receive only the record printout
 - 3c. Press LABEL to receive only the label printout
 - 3d. Press NONE if no printouts are desired.

NOTE: After printing has completed for either the RECORD, LABEL or BOTH, the control will continue to display the print menu until NONE is selected. This allows for multiple copies of each to be printed as needed.



- 4) Repeat for any remaining probes as they complete in turn. Pressing NONE after the final probe has completed returns the display to the MAIN MENU.
- 5) Any probes used should be properly sanitized prior to use in another batch.



For more details and/or to make use of other control features please refer to pages 12 - 23 of this manual.

Basic Operating Guidelines

Chilling Within HACCP Guidelines

- 1) The current FDA Food Code allows much more time for safe chilling than 90-minutes. This actually requires two critical control points of:
 - a) From 135°F to 70°F within two hours, then...
 - b) From 70°F to below 41°F within four hours, for a total chill time from 135°F to below 41°F of no more than six hours.
- 2) Total chill times can exceed six hours in duration and still be safe. This safety threshold does not include:
 - a) Any time needed for product to chill from any start temp down to 135°F, or...
 - b) Any time elapsed to chill to below 41°F.



Loading

- 1) To achieve quickest chill times product should be loaded into pans to a depth of no greater than 2".
- 2) Products should always be loaded into the shallowest pan possible.
- 3) Chilling of products of greater than 2" depth is often possible within FDA guidelines. However please note that actual chill times are a function of: Start Temperature, Product Density, Product Depth, and Total Load.
- 4) Chilling of products, such as whole cooked chickens or meatloaf can be accomplished. However these should be positioned inside the chiller to allow the air-flow to contact the greatest surface area of the product.



Covering

- 1) Product does not always need to be covered. However before doing so please consider the following potential scenarios...
 - a) If large loads of especially hot product are chilled there is the potential to freeze the coil.
 - b) Loads of uncovered product that require especially long chilling times may have the potential to experience surface drying.
 - c) Loads that are left uncovered in the chiller for long periods after completion of a chill cycle may also experience surface drying of the product if left uncovered.
 - d) Loads of especially liquid product, such as soup, are highly recommended to be covered in order to prevent accidental spillage.
 - e) Some foods, such as rice and pasta, are particularly vulnerable to drying and so should always be covered.

Use of Food Probes

- 1) For most accurate results food probes should be used. These need to be properly placed in the center of the thickest part of the product to insure an accurate temperature reading.
- 2) Some products are not suitable for use of food probes. These products...
 - a) Should be chilled BY TIME.
 - b) The correct chill time should be established by the operator based upon actual product testing.
 - c) The end cycle temperature should be verified manually with a clean, accurate thermometer as soon as the pre-established chill time elapses.



For details about using your Traulsen blast chiller within a cook/chill operation please refer to form number TR99999.

II. RECEIPT INSPECTION

All Traulsen products are factory tested for performance and are free from defects when shipped. The utmost care has been taken in crating this product to protect against damage in transit. All interior fittings have been carefully secured and the legs or casters are boxed and strapped inside to prevent damage. Door keys will be attached to the handle with a nylon strip. The handle is protected by an easily removable nylon netting.

You should carefully inspect your Traulsen unit for damage during delivery. If damage is detected, you should save all the crating materials and make note on the carrier's Bill Of Lading describing this. A freight claim should be filed immediately. If damage is subsequently noted during or immediately after installation, contact the respective carrier and file a freight claim. Under no condition may a damaged unit be returned to Traulsen without first obtaining written permission (return authorization).

III. INSTALLATION

III. a - LOCATION:

Select a proper location for your Traulsen unit, away from extreme heat or cold. Allow enough clearance between the unit and the side wall so that the door (s) may open a minimum of 90°.

III. b - PACKAGING:

All Traulsen units are shipped from the factory bolted to a sturdy wooden pallet and packaged in a durable cardboard container. The carton is attached to the wooden skid with the use of large staples. These should first be removed to avoid scratching the unit when lifting off the crate.

To remove the wooden pallet, first if at all possible, we suggest that the cabinet remain bolted to the pallet during all transportation to the point of final installation. The bolts can then be removed with a 3/4" socket wrench. Avoid laying the unit on its front, side or back for removal of the pallet.

NOTE: Traulsen does not recommend laying the unit down on its front, side or back. However, if you must please be certain to allow the unit to remain in an upright position afterwards for 24 hours before plugging it in so that the compressor oils and refrigerant may settle.

III. c - WIRING DIAGRAM:

Refer to the wiring diagram for any service work performed on the unit. Should you require a wiring diagram, please contact Traulsen Service at (800) 825-8220, and provide the model and serial number of the unit involved.

III. d - INSTALLING LEGS OR CASTERS:

6" high stainless steel legs are supplied standard for models RBC50 and RBC100. Casters in lieu of legs are available as an optional accessory for the same models. These are shipped from the factory packed inside a cardboard box which is strapped to one of the shelves. Remove the nylon strap and open the box, it should contain either four (4) legs or casters (and four bolts for each caster).

III. INSTALLATION (continued)

III. d - INSTALLING LEGS OR CASTERS (cont'd):

WARNING: THE CABINET MUST BE BLOCKED AND STABLE BEFORE INSTALLING LEGS OR CASTERS.

To install the legs or casters, first raise and block the unit a minimum of 7" from the floor.

For model RBC50 slide the legs or casters into the two channels under the front and back of the cabinet. Secure in place by tightening the two bolts located at the base of each leg or caster (see figure 1).

NOTE: Legs or casters must be installed towards the four corners of the unit for proper support.

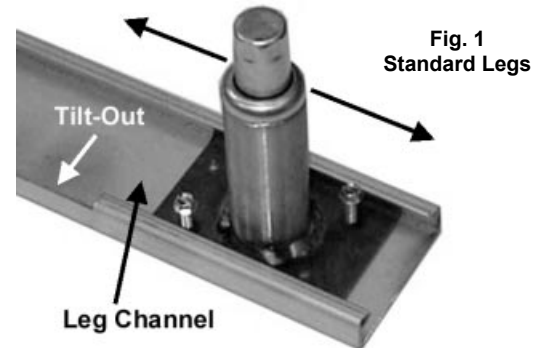

On model RBC100 thread the legs into the threaded holes on the bottom of the cabinet (see fig. 2). Be certain that all legs are tightened securely. When the unit is set in its final position, it is important for proper operation that the unit be level. The legs are adjustable for this purpose, turn the bottom of the leg counter-clockwise to raise it, clockwise to lower it. Level the unit from front to back as well as side to side in this manner, using a level placed in the bottom of the cabinet.

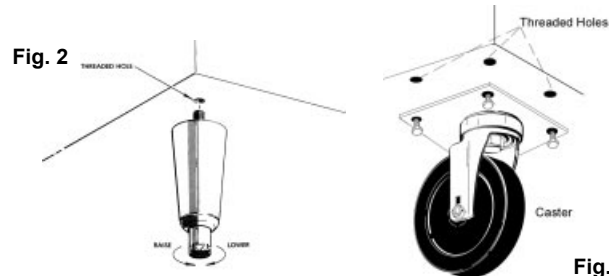

-For installing optional casters, these are "plate" type, and require the use of four (4) bolts to secure them firmly to the cabinet bottom at each corner (see figure 3). The caster bolts are tightened using a 1/2" socket wrench.

II. e - ASSEMBLY OF MODELS RBC400 & RBC400RT:

Double depth roll-in/roll-thru units are shipped as two separate components which must be attached together at the jobsite. To accomplish this, first, place the front and rear cabinets in close proximity to each other being careful to align the drain from the front of the rear unit to the drain of the front unit. It will be necessary to level both units together at this time.

Next, using two pipe clamps, pull the units together (see figure 4). Install the covers over the gap formed between the units. From inside the cabinets install the breaker strips using the strip as a template (screws provided).

III. INSTALLATION (continued)

II. e - ASSEMBLY OF MODELS RBC400 & RBC400RT:

Fig. 4 - Using two pipe clamps, pull the two units together and using the screws provided. Align the breaker strips as a template for the screw pattern inside and outside the cabinet.

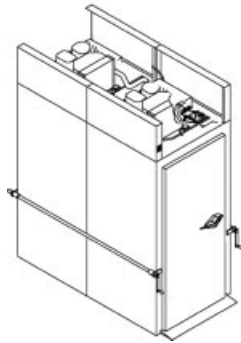

III. f - CORD & PLUG:

All Traulsen Blast Chill models (except model RBC100 which is supplied with a cord set but no plug) are supplied with a cord & plug attached (for models RBC200 and RBC200RT, the cord and plug supplied is for the self-contained maintenance compressor only, the 4HP remote condensing unit requires a separate electrical connection of its own). It is shipped coiled at the top of the cabinet, secured by a nylon strip. For your safety and protection, all units supplied with a cord and plug include a special three-prong grounding plug on the service cord. Select only a certified electrical outlet with grounding plug for power source. **NOTE:** Do not under any circumstances, cut or remove the round grounding prong from the plug, or use an extension cord.

III. g - ELECTRICAL REQUIREMENTS:

Model RBC50 is provided with one NEMA 5-15P cord and plug.

Model RBC100 is normally provided with a grounding type cord without a plug. A dedicated 220/60/1 volt, 4 wire, 20 amp grounded circuit with receptacle should be provided by a certified electrician to assure that the computerized control is not adversely affected by the operation of other equipment.

Models RBC200/RBC200RT are normally provided with one (RBC400/RBC400RT are provided with two) grounded cordset (NEMA 5-20P). A dedicated 115/60/1 volt, 20 amp, grounded circuit should be provided by a certified electrician to assure that the computerized control is not adversely affected by the operation of other equipment.

III. h - PROPER CLEARANCES:

Model RBC50: Make certain that there are no obstructions in front of the left side louver panel. This will allow for sufficient air flow to the refrigeration system and maintenance access.

Model RBC100: A minimum of 4" clearance on the right side, 6" on the left side and 6" clearance in the rear (see figure 5). This will allow for sufficient air flow to the refrigeration system and maintenance access.

Models RBC200/RBC200RT & RBC400/RBC400RT: Insure an overhead clearance of 12" and a rear clearance of 4" (see figure 6). This will allow for sufficient air flow to the refrigeration system and maintenance access.

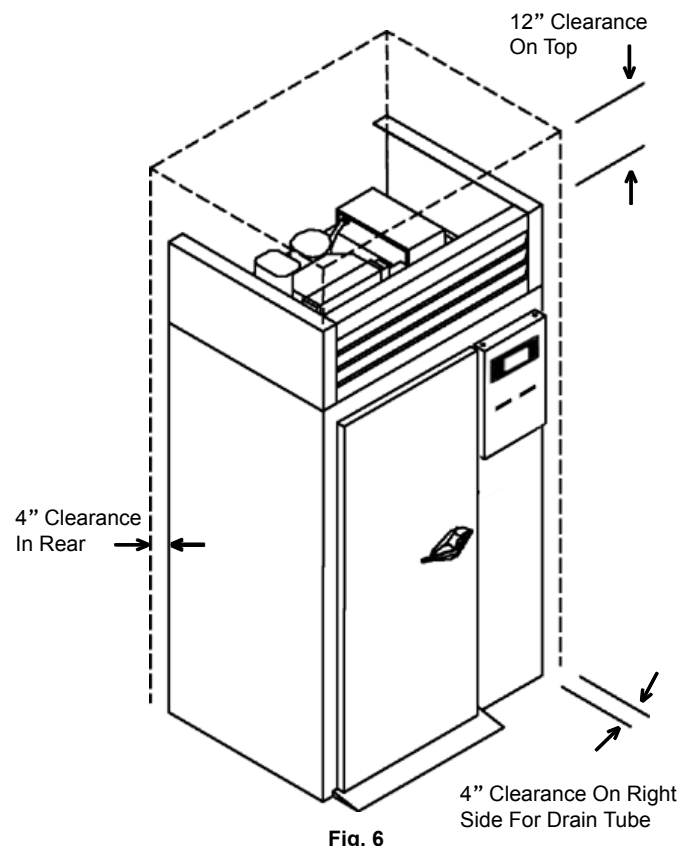
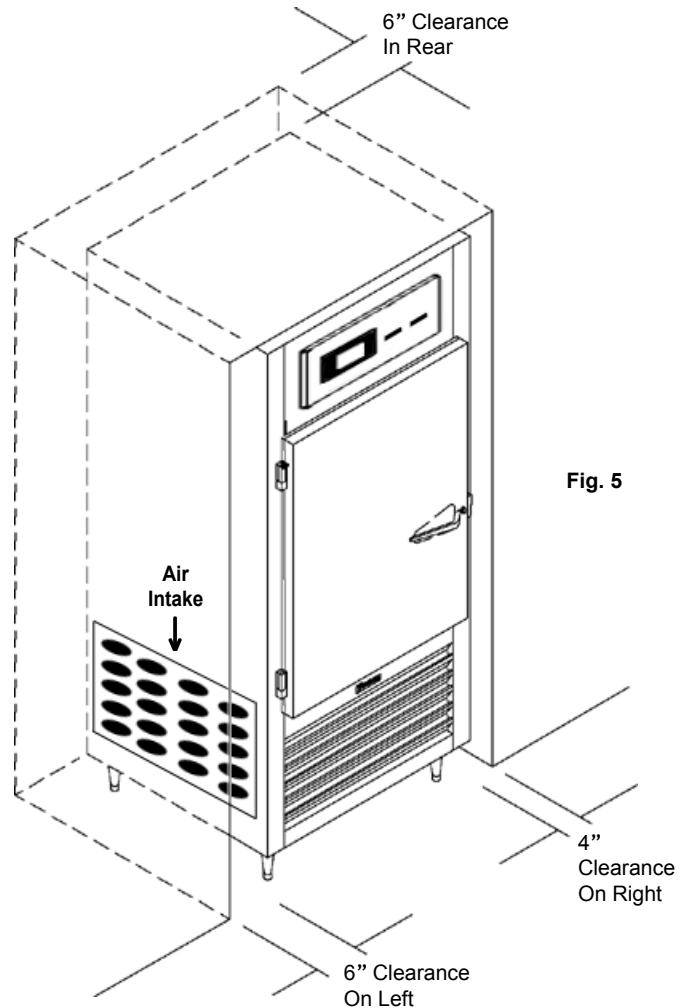

III. INSTALLATION (continued)

III. i - CONDENSATE REMOVAL:

All Traulsen Blast Chill models (except model RBC50) require the use of a floor drain or floor mounted electric condensate evaporator.

Model RBC100 requires either a floor drain or the use of an optional bottom mounted electric condensate evaporative pan kit (BCACC-BMCE) for condensate removal. The standard drain port location is at the rear of the unit (see figure 7).

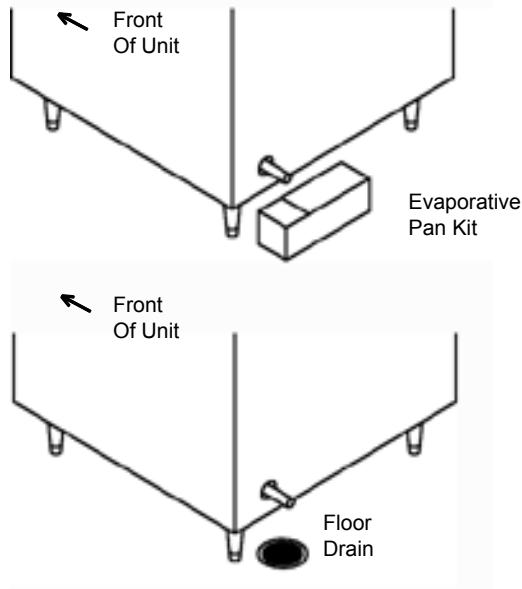

Fig. 7

Models RBC200 and RBC200RT require either a floor drain or the use of an optional floor mounted electric condensate evaporative pan kit (BCACC-FMCE) for condensate removal. Two drain ports are provided, located at the right side and rear of the unit. Plug the unused drain port with the male pipe thread plug supplied (see figure 8).

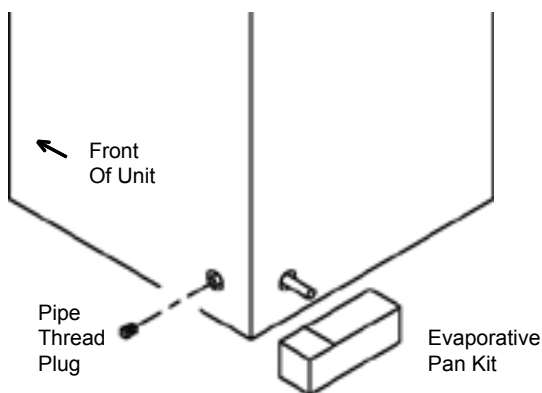

Fig. 8

NOTE: Local code should be consulted when plumbing to drain port.

III. j - REMOTE CONDENSING UNIT REQUIREMENTS:

This section applies only to models RBC200/200RT and RBC400/400RT. A remote condensing unit, operating on R-404A refrigerant, is required for Blast Chill operation on these models. The remote condensing unit should be capable of providing 18,700 BTU/hr @ -10°F evaporator temperature in a 90°F ambient environment.

4 HP air-cooled and 3 HP water-cooled remote condensing units are available from Traulsen as an optional accessory. Increased capacity of the remote condensing unit and line sizing will depend on the length and layout of the connecting piping from the remote condensing unit to the Blast Chill unit. Proper line sizing should be defined by a qualified refrigeration engineer or technician.

III. k - REMOTE UNIT CUT-OUT SETTINGS:

This section applies only to models RBC200/200RT and RBC400/400RTRT. The low pressure cut-out of the remote condensing unit should be adjusted to obtain an evaporator coil temperature NO LOWER THAN -15°F. If the length of the connecting piping is 40 feet or less, the condensing unit low pressure cut-out settings will be approximately 15 +/- 2 PSIG cut-out and 25 +/- 3 PSIG cut-in.

III. l - SEALING ROLL-IN/ROLL-THRU UNITS:

This section applies only to models RBC200/200RT and RBC400/400RTRT. Roll-In and Roll-Thru cabinets set on the floor require the floor area to be flat and level. In addition, after the cabinet is set in place, sealant should be used around the perimeter of the base to comply with NSF International requirements. After sealing the unit, the enclosed ramp should then be installed.

III. m - ON/OFF SWITCH:

The Traulsen Blast Chiller models are all equipped with a power ON/OFF switch intended to cut power to the control as needed. In the event of routine maintenance and/or service is needed, be certain to disconnect the electrical power to the machine and follow lockout/tagout Procedures.

This is located on top of models RBC100, RBC200, RBC200RT, RBC400 and RBC400RT behind the louver panel assembly. On model RBC50, this switch is located on the right side of the control tower.

III. INSTALLATION (continued)

III. n - INSTALLING RBC50 CONTROL PANEL:

Older versions of Model RBC50 (those built prior to Jan. '08) are shipped with the control panel detached, and laid flat, taped to the cabinet top (see figure 9). This must be installed before use. To install:

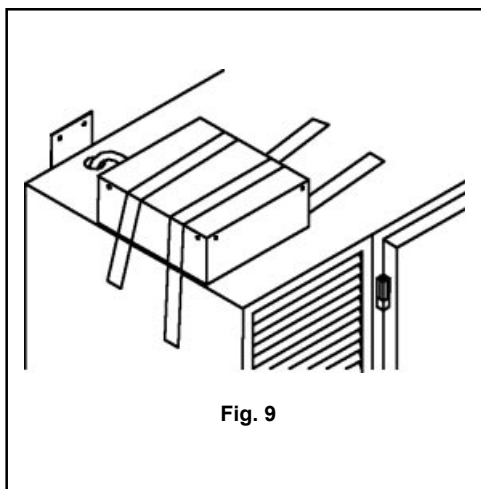

Remove the packing material and tape holding the control to the top. Remove and retain the six (6) Phillips head screws attaching the control cover to the frame. Also, remove and retain the 1/4- 20 x 1/2" screws found in the cabinet top. Next, position the control frame over the hole in the unit top and attach using 1/2-20x1/2" screws (see figure 10).

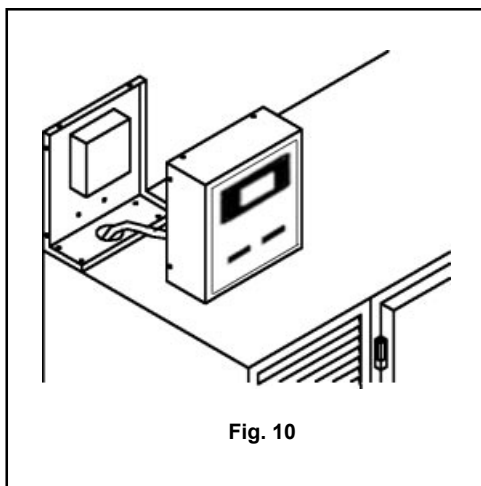

NOTE: Extreme care needs to be taken to insure that:
a- all wires connecting the control cover to the RBC50 are not damaged in any way, nor mistakenly mounted between the cover and cabinet during installation, which could result in a short circuit, or...
b- that no connections are pulled off the control.

NOTE: Ensure that grommet is firmly in place, aligning round hole in bottom of control housing with round hole in unit top.

Inspect paper roll, label roll, and spindles from rear of control panel before installing panel. Reattach the control cover to the frame using the six (6) Phillips head screws previously removed.

IV. CARE & MAINTENANCE

WARNING: DISCONNECT ELECTRICAL POWER SUPPLY BEFORE CLEANING ANY PARTS OF THE UNIT.

IV. a - CLEANING THE CONDENSER:

The most important thing you can do to insure a long, reliable service life for your Traulsen is to regularly clean the condenser coil. The self-contained condensing unit requires regularly scheduled cleaning to keep the finned condenser clean of lint and dust accumulation. Keeping the condenser clean allows the cabinet to operate more efficiently and use less energy.

To clean the self-contained condenser, first disconnect electrical power to the cabinet and lift up the front louver assembly. To lift this, remove the two screws located on both sides at the bottom of the louver assembly. Once the screws are removed, the panel can be pivoted upwards allowing full access to the front facing condenser (for model RBC50, remove the four Phillips head screws from the front louver panel, and lift-off). Vacuum or brush any dirt, lint or dust from the finned condenser coil, the compressor and other cooling system parts. If significant dirt is clogging the condenser fins, use compressed air to blow this clear. Lower louver assembly and replace screws to hold it in place. For care of the remote condensing unit(s) used for models RBC200 & RBC200RT, consult the manufacturer's product literature.

IV. b - PRINTER SUPPLIES:

Supplies to support the both standard SmartChill® control printers are available directly from our Parts Department, or from your local Hobart Sales and Service Office. In addition it may also be possible to obtain one of these locally. The record printer paper is standard thermal paper which is readily available at most office supply outlets. Specifications are 2-1/2" wide by 85" long:

Traulsen P/N [400-60003-00](#)
Office Depot #302-224
Staples #PMF-5233

The label printer uses a special peel-off label stock, Traulsen part number [400-60004-00](#). Each roll contains 225 labels.

IV. c - INSTALLING PRINTER PAPER:

To load the record printer paper, place a roll on the roll shaft. Position the paper such that the paper feeds from the back of the roll. This allows the thermal sensitive side of the paper to be on the upper surface as it feeds through the printer. The ends of the roll shaft are installed in the two roll holders.

Gently pull the feed door down and slightly forward. It is located on the bottom of the printer and will open about 90 degrees. Feed the paper into the loading slot directly behind the door and push it up until the paper

IV. CARE & MAINTENANCE (cont'd)

IV. c - INSTALLING PRINTER PAPER (cont'd):

extends about 1/4" in front of the printer. Then return the feed door to its original position. If the feed door is not closed, the printer will not operate. Labels are loaded in the same manner. The label printer is located to the right of the record printer as you look at the unit. After turning the unit on, the label printer will automatically orient itself for the next label.

IV. d - CLEANING THE EXTERIOR:

Exterior stainless steel should be cleaned with warm water, mild soap and a soft cloth. Apply with a dampened cloth and wipe in the direction of the metal grain.

Avoid the use of strong detergents and gritty, abrasive cleaners as they may tend to mar and scratch the surface. Do NOT use cleansers containing chlorine, this may promote corrosion of the stainless steel.

Care should also be taken to avoid splashing the unit with water, containing chlorinated cleansers, when mopping the floor around the unit. For stubborn odor spills, use baking soda and water (mixed to a 1 TBSP baking soda to 1 pint water ratio).

IV. e - CLEANING THE INTERIOR:

For cleaning stainless steel interiors, the use of baking soda as described in section "IV. b" is recommended. Use on breaker strips as well as door gaskets. All interior fittings are removable without tools to facilitate cleaning. A defrost cycle is the ideal time for performing interior cleaning. For more information on the care of stainless steel finishes, please refer to section XV.

V. OTHER

V. a - RBC200/RT SERVICE AGENCY CHECK & START-UP:

After installation and start-up of models RBC200 or RBC200RT, please contact the Service Department at (800) 825-8220 to arrange for a "Mechanical Installation and Operation Inspection," which is required by Traulsen in order to validate the warranty. On-site inspection not required for models RBC50 and RBC100.

V. b - ON-SITE BLAST CHILL TRAINING:

Traulsen offers the operator comprehensive one and two day, on-site training in the proper operation of your Blast Chiller. Contact your authorized Traulsen equipment dealer for pricing information.

V. c - SERVICE INFORMATION:

Before calling for service, please check the following:

- Is the electrical cord plugged in?
- Is the fuse OK or circuit breaker on?
- Is the ON/OFF Power Switch in the ON position?

V. OTHER

V. c - SERVICE INFORMATION (cont'd):

If after checking the above items and the unit is still not operating properly, please contact Traulsen (if under warranty) or an authorized Traulsen service agent. A complete list of authorized service agents was provided along with your Traulsen unit. If you cannot locate this, you may also obtain the name of a service agent from the Service/Contact page of our website: www.traulsen.com.

If service is not satisfactory, please contact our in-house service department at:

Traulsen
4401 Blue Mound Road
Fort Worth, TX 76106
(800) 825-8220

Traulsen reserves the right to change specifications or discontinue models without notice.

V. d - DEMONSTRATIONS:

Traulsen sales representatives perform in-service operational training for the end-user. Contact your local Traulsen Sales Representative (after completion of the service agency start-up, on required models) to arrange this.

V. e - SMARTCHILL DATA COMMUNICATIONS KIT:

Each Traulsen blast chiller is communications capable. To make use of the optional communications feature, please refer to section "X." of this manual.

V. f - THE SERIAL TAG:

The serial tag is a permanently affixed sticker on which is recorded vital electrical and refrigeration data about your Traulsen product, as well as the model and serial number. This tag is located inside the door on the right interior wall of the cabinet.

READING THE SERIAL TAG

- Serial = The permanent ID# of your Traulsen
- Model = The model # of your Traulsen
- Volts = Voltage
- Hz = Cycle
- PH = Phase
- Total Current = Maximum amp draw
- Minimum Circuit = Minimum circuit ampacity
- Lights = Light wattage
- Heaters
- Refrigerant = Refrigerant type used
- Design Pressure = High & low side operating pressures and refrigerant charge
- Agency Labels = Designates agency listings

VI. THE SMARTCHILL® CONTROL

VI. a - THE SMARTCHILL CONTROL - OVERVIEW:

This unit is equipped with our exclusive SmartChill® microprocessor control (Traulsen Blast Chill units manufactured prior to 6/03 were equipped with the DIGITRAUL II control, please refer to owner's manual part number 375-60180-00 for more information).



The SmartChill® Controller

The SmartChill® controller provides the ability to:

- Select the chill mode: By Product, By Time or By Temperature (chill or freeze)
- Display the current air and product temperatures and time.
- Monitor product temperatures with three smart probes to reduce chances of freezing.
- Select Soft Chill to reduce the chances of freezing in the final phase of chilling.
- Provide service diagnostics to quickly check machine functions and control circuitry.
- Send Chill® Cycle data via an RS232 port to SmartChill® computer software, providing state of the art HACCP data management.

VI. b - PRINTING CAPABILITY:

The standard printer provides the ability to:

- Print data from the last chill cycle with time, date, and temperature information.
- Charts chill temperatures vs. time at intervals that can be set by the supervisor.

The label printer can print a condensed "LABEL" type of report with both PRODUCT and USER information.

VI. c - CONTROL BASICS:

Begin by choosing a selection from the menu that appears on the control's display by pressing the button graphically connected to the display prompt. Four buttons are arranged on the left and four on the right. For example, to select BY TEMP, press the second button on the left.

VI. d - START-UP:

When power is turned ON to the blast chiller the start-up screen below appears.

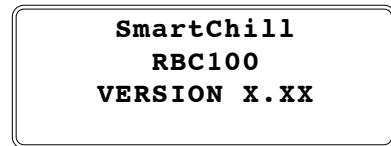

VI. e - OVER TEMPERATURE:

An OVER TEMPERATURE situation occurs if interior cabinet air temperature rises to 160°F or above. The unit will shut down and a service technician should be notified.

VI. f - IN THE EVENT OF A POWER INTERRUPTION:

Following a power interruption, the system resumes at the previous activity. A report will also be printed containing the time of the power loss and the time of power return.

VI. g - GETTING STARTED:

The Traulsen Blast Chiller is designed to chill its respective capacity of hot product from 135°F down to 40°F in approximately 90 minutes if loaded in pans no more than 2" deep. However, it is important to follow all the preceding guidelines for product loading and batching in order to duplicate this performance on-site.

Once you have insured that product is properly loaded into the pans and batched correctly, proceed to the next section in order to correctly operate the SmartChill controls chill feature modes.

VI. h - EZ START FEATURE:

All Traulsen Blast Chillers built after June 1, 2006 include an "EZ-Start" feature which allows a blast chill batch to be initiated with the touch of a single button located on the main menu.

Please note that in order to use this feature, one or more of the food probes must first be placed into hot product which is at least 40°F warmer than the interior cabinet temperature

When using this feature the factory preset chill cycle parameters are: Blast Chill, By Temperature, with a product end-point of 37°F, and are not adjustable by the operator.

VII. OPERATING THE BLAST CHILL CONTROL - STARTING A CHILL CYCLE

```

MAIN MENU    AIR 35°F
◀BY TEMP    BY PROD▶
◀BY TIME
08:05:01    MORE▶
    
```

Main Menu Display

```

MAIN MENU    AIR 35°F
◀BY TEMP    BY PROD▶
◀BY TIME
08:05:01    MORE▶
    
```

```

BY TEMPERATURE
◀TYPE: CHILL
↓TARGET TEMP: 37°F↑
◀MAIN        START▶
    
```

```

BY TEMPERATURE
◀TYPE: CHILL
↓TARGET TEMP: 0°F↑
◀MAIN        START▶
    
```

VII. a - STARTING A CHILL CYCLE - BY TEMP:

Use of the chilling mode BY TEMPERATURE means that product will be constantly chilled until the food probe(s) temperature reaches the preset target temperature, at which time the cycle is complete and operation reverts to normal refrigerated holding mode.

The main menu should be displayed on the control. To begin a chill cycle BY TEMPERATURE follow the below instructions:

STEP ONE: Press the button to the left of where BY TEMPERATURE is shown on the display. The menu will then change to show TYPE : CHILL.

STEP TWO: Select the TYPE by pressing the button to the left of where by TYPE is shown on the display. The display will change between CHILL (blast chill mode), SOFT (soft chill mode) and FREEZE (freeze chill mode).

STEP THREE: Adjust the TARGET TEMPERATURE if you wish to deviate from the factory preset temperatures (see chart below). This is done by pressing the buttons to the left and right of the UP and DOWN arrows.

MODELS	BY TEMP	FACTORY PRESET TARGET RANGE	RANGE
All Models	Blast Chill	37°F	33-40°F
All Models	Soft Chill*	37°F	33-40°F
All Models	Freeze*	0°F	-22-28°F

*Soft Chill and Freeze modes are not available on GC units.

STEP FOUR: Insert the food probes into the food product as shown in section VI. a.

NOTE: The SmartProbes sense the product temperature and are automatically selected (if product temperature is 75°F or higher). If probes are not sensed, probes have to be enabled using the SELECT PROBE menu.

```

BY TEMPERATURE
◀TYPE: CHILL
↓TARGET TEMP: 37°F↑
◀MAIN        START▶
    
```

```

BY TEMPERATURE
◀TYPE: CHILL
↓TARGET TEMP: 37°F↑
◀MAIN        START▶
    
```

```

CHILLING    AIR: 14°F
◀1 41°F    DONE 3▶
◀2 44°F
1:16:01    MUTE▶
    
```

STEP FIVE: Close the door. You are now ready to begin chilling. If you are satisfied with the selections made in steps 1 thru 3, press the button to the right of where START is shown on the display. The chill time will display in the lower left corner of the display: Hr: Min: Sec: (hours:minutes:seconds).

NOTE: You can return to the MAIN MENU at any time by pushing the button to the left of where MAIN is shown on the display.

When a programmed batch has reached completion the alarm will activate, providing an audible notification (buzzer). This can be turned OFF by pressing the button to the right of where MUTE is shown on the display.

(This step is repeated as each probe reaches the target temperatures; see page 14).

NOTE: After completion of all batches the unit will return to normal refrigerated holding temperatures (37°F). Product which was either BLAST or SOFT chilled may remain in the blast chiller. However, if a FREEZE CHILL cycle was completed product must be removed immediately upon batch completion.

VII. OPERATING THE BLAST CHILL CONTROL - STARTING A CHILL CYCLE

VII. a - STARTING A CHILL CYCLE - BY TEMP (cont'd):

STEP SIX: Select the "done" probe(s) by pressing the button(s) to the left or right of where that number probe(s) is displayed. Remove all product associated with the "done" probe(s) from the chiller. If all probes have completed their respective batches, the display changes to the HOLDING screen menu.

To remove a product before it is completed press the button to the right of where ADD/REMOVE is shown on the display. Select any other probe's number to stop cycle and remove it. Answer, by pressing the button to the left/right of where NO/YES is shown on the display.

STEP SEVEN: The display will ask if you want to print a chill cycle data report and/or label for that particular probe.

- 1) RECORD = Print probe report on standard printer only
- 2) LABEL = Print probe report on label printer only
- 3) BOTH = Print probe report on both standard and label printers.

To continue chilling without printing either, press the button to the left of where NONE is shown on the display.

To print a chill report for this probe, press the button to the right of where RECORD is shown on the display.

To print a label for this probe, press the button to the right of where LABEL is shown on the display.

To print a both chill report and label for this probe, press the button to the right of where BOTH is shown on the display.

Multiple records and/or labels may be printed by pressing the appropriate button after previous printing is completed. When finished printing press NONE and the display will return to the MAIN MENU or PROBE MENU if there are still active probes.

Repeat as necessary when each probe reaches completion. When all probes are DONE, return to the MAIN MENU.

```
HOLDING      AIR 37°F
◀1 DONE      DONE 3▶
◀2 DONE
1:16:01      ADD/REMOVE▶
```

```
CHILLING     AIR 14°F
◀1 41°F      DONE 3▶
◀2 44°F
1:16:08      CONTINUE▶
```

```
SELECT PROBE:
◀1 39°F      REMOVE 3▶
◀2 44°F
1:16:28      CONTINUE▶
```

```
STOP CYCLE ON #2

REMOVE PRODUCT?
◀NO          YES▶
```

```
PRINT PROBE #
                RECORD
                LABEL ▶
◀NONE          BOTH ▶
```

```
PRINTING

PLEASE WAIT...
```

VII. OPERATING THE BLAST CHILL CONTROL - STARTING A CHILL CYCLE

```

MAIN MENU    AIR 35°F
◀BY TEMP    BY PROD▶
◀BY TIME
08:05:01    MORE▶
    
```

Main Menu Display

```

MAIN MENU    AIR 35°F
◀BY TEMP    BY PROD▶
◀BY TIME
08:05:01    MORE▶
    
```

```

BY TIME
◀TYPE: CHILL
↓CYCLE TIME: 01:30↑
◀MAIN      START▶
    
```

```

BY TIME
◀TYPE: CHILL
↓CYCLE TIME: 01:30↑
◀MAIN      START▶
    
```

NOTE: If desired you may insert the food probes into the food product as shown in section VI. a., however please be aware that these will only display the product temperatures and have no effect on the chilling process in this mode.

```

BY TIME
◀TYPE: CHILL
↓CYCLE TIME: 01:30↑
◀MAIN      START▶
    
```

```

BY TIME
◀TYPE: CHILL
↓CYCLE TIME: 01:30↑
◀MAIN      START▶
    
```

```

HOLDING    AIR: 14°F
◀1 41°F    43°F 3▶
◀2 44°F
1:16:01    MUTE▶
    
```

```

HOLDING    AIR 35°F
1 159°F    156°F 3
2 154°F
1:30:00    STOP/RESET▶
    
```

```

BY TIME
    ADD 30 MINUTES▶
    RESET TIMER▶
◀STOP      CONTINUE▶
    
```

VII. b - STARTING A CHILL CYCLE - BY TIME:

Use of the chilling mode BY TIME means that product will be constantly chilled until the set chill time, as determined by the operator, has elapsed, at which time the cycle is complete and operation reverts to normal refrigerated holding mode.

The main menu should be displayed on the control. To begin a chill cycle BY TIME follow the below instructions:

STEP ONE: Press the button to the left of where BY TIME is shown on the display. The menu will then change to show TYPE : CHILL.

STEP TWO: Select the TYPE by pressing the button to the left of where by TYPE is shown on the display. The display will toggle between CHILL (blast chill mode), SOFT (soft chill mode) and FREEZE (flash chill mode) each time you press this button.

STEP THREE: Adjust the CYCLE TIME (not required) if you wish to deviate from the factory preset times (see chart below). This is done by pressing the buttons to the left and right of the UP and DOWN arrows.

MODELS	BY TEMP	INITIAL TIME SETTING	TIME RANGE
All Models	Blast Chill	01:30	00:01 To 09:00
All Models	Soft Chill	01:30	00:01 To 09:00
All Models	Freeze	01:30	00:01 To 09:00

STEP FOUR: Close the door. You are now ready to begin chilling. If you are satisfied with the selections made in steps 1 thru 3, press the button to the right of where START is shown on the display. The chill time remaining will display in the lower left corner of the display: Hr: Min: Sec: (hours:minutes:seconds).

NOTE: Prior to selecting START you can return to the MAIN MENU at any time by pushing the button to the left of where MAIN is shown on the display.

When a programmed batch has reached completion (i.e. the timer has counted down to 0:00:00) the alarm will activate, providing an audible notification (buzzer). This can be turned OFF by pressing the button to the right of where MUTE is shown on the display.

NOTE: After completion of a batch the unit will return to normal refrigerated holding temperatures (37°F). Product which was either BLAST or SOFT chilled may remain in the blast chiller. However, if a FREEZE CHILL cycle was completed product must be removed immediately upon batch completion.

OTHER BY TIME CONTROL FUNCTIONS

During a chill cycle BY TIME, the control has several preset functions that can be accessed by pressing the button to the left of where STOP/RESET is shown on the display.

- **ADD 30 MINUTES:** adds 30 additional minutes to the timer.
- **RESET TIMER:** re-starts the timer at the original time setting.
- **CONTINUE:** resumes the cycle at the time remaining.
- **STOP:** control returns to the MAIN MENU.

VII. OPERATING THE BLAST CHILL CONTROL - STARTING A CHILL CYCLE

VII. c - STARTING A CHILL CYCLE - BY PRODUCT:

Use of the chilling mode **BY PRODUCT** allows the operator to select from a listing of chill parameters for various previously programmed products. These products will then be chilled either **BY TEMPERATURE** or **BY TIME**, depending upon their individual settings. When the chill cycle is completed operation reverts to normal refrigerated holding mode.

The main menu should be displayed on the control. To begin a chill cycle **BY PRODUCT** follow the below instructions:

STEP ONE: Insert the food probes into the food product as shown in section VI. a and close the door.

STEP TWO: Press the button to the right of where **BY PRODUCT** is shown on the display. The menu will then change to show **TYPE: CHILL**.

STEP THREE: Select the **USER** (if more than one user has been previously entered) by pressing the buttons to the left and right of the **UP** and **DOWN** arrows.

STEP FOUR: Select the **PRODUCT** to be chilled. The display will show the two most recently chilled products. You can scroll through the listing of products by pressing the buttons to the left of the **UP** and **DOWN** arrows. See page 16 for more information.

STEP FIVE: Once the product you wish to chill is shown on the display, press the button to the right of where this is shown to recall that product's chill parameters and begin chilling.

If the product selected is being chilled **BY TEMPERATURE**, the chill cycle time will be shown in the lower left corner of the display: Hr: Min: Sec: (hours:minutes:seconds).

If the product selected is being chilled **BY TIME**, the time remaining will be shown in the lower left corner of the display: Hr: Min: Sec: (hours:minutes:seconds).

NOTE: You can return to the **MAIN MENU** at any time by pushing the button to the left of where **MAIN** is shown on the display.

When a programmed batch has reached completion the alarm will activate, providing an audible notification (buzzer). This can be turned **OFF** by pressing the button to the right of where **MUTE** is shown on the display.

(This step is repeated as each probe reaches the target temperatures; see page 14).

NOTE: After completion of all batches the unit will return to normal refrigerated holding temperatures (37°F). Product which was either **BLAST** or **SOFT** chilled may remain in the blast chiller. However, if a **FREEZE CHILL** cycle was completed product must be removed immediately upon batch completion.

Refer to page 14 or 19 for printing procedures and information.

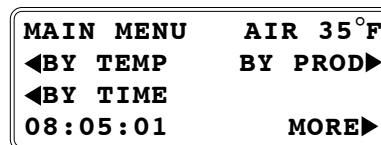

Main Menu Display

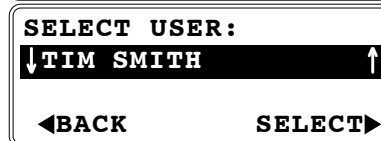
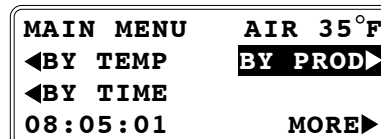

NOTE: If the product you wish to select is on the Product List shown on page 20 but is not available from the **SELECT PRODUCT** menu of the control display, it first needs to be enabled. The Supervisor should refer to Set-Up Products on page 23.

VII. OPERATING THE BLAST CHILL CONTROL - STARTING A CHILL CYCLE

VII. d - THE CHILL BY PRODUCT FEATURE - PRODUCT LIST:

Any product from the PRODUCT LIST can be chilled using the BY PROD mode, once it has been enabled in Setup Products (page 22). Only CHICKEN PARTS and SOUP VEGETABLE are initially enabled as preset at the factory.

NOTE: All products are initially set in the BY TEMP - CHILL mode with a Target Temperature of 37°F and Holding Temperature of 37°F.

- | | | |
|---|---|--|
| <input type="checkbox"/> ASPARAGUS | <input type="checkbox"/> LAMB | <input type="checkbox"/> SALAD POTATO |
| <input type="checkbox"/> BEANS | <input type="checkbox"/> LASAGNA | <input type="checkbox"/> SANDWICHES |
| <input type="checkbox"/> BEANS BAKED | <input type="checkbox"/> LIVER | <input type="checkbox"/> SAUCE |
| <input type="checkbox"/> BEEF | <input type="checkbox"/> MACARONI & CHEESE | <input type="checkbox"/> SAUCE CHEESE |
| <input type="checkbox"/> BEEF CREAMED | <input type="checkbox"/> MACARONI & GROUND BEEF | <input type="checkbox"/> SAUCE MEAT |
| <input type="checkbox"/> BEEF ROAST | <input type="checkbox"/> MEAT | <input type="checkbox"/> SAUCE TOMATO |
| <input type="checkbox"/> BEEF TIPS | <input type="checkbox"/> MEAT GROUND | <input type="checkbox"/> SAUSAGE |
| <input type="checkbox"/> BROCCOLI | <input type="checkbox"/> MEAT LOAF | <input type="checkbox"/> SOUP BEAN |
| <input type="checkbox"/> CABBAGE STUFFED | <input type="checkbox"/> MEAT SLICED | <input type="checkbox"/> SOUP CREAM OF CELERY |
| <input type="checkbox"/> CARROTS | <input type="checkbox"/> MEAT WITH SAUCE | <input type="checkbox"/> SOUP POTATO |
| <input type="checkbox"/> CASSEROLE | <input type="checkbox"/> OATMEAL | <input type="checkbox"/> SOUP TOMATO |
| <input type="checkbox"/> CEREAL COOKED | <input type="checkbox"/> PASTA | <input checked="" type="checkbox"/> SOUP VEGETABLE |
| <input type="checkbox"/> CHICKEN & DUMPLINGS | <input type="checkbox"/> PEAS | <input type="checkbox"/> SPAGHETTI |
| <input checked="" type="checkbox"/> CHICKEN PARTS | <input type="checkbox"/> PEPPERS STUFFED | <input type="checkbox"/> STARCH DISH |
| <input type="checkbox"/> CHICKEN POT PIE | <input type="checkbox"/> PORK | <input type="checkbox"/> STEAK |
| <input type="checkbox"/> CHOWDER CORN | <input type="checkbox"/> PORK CHOPS | <input type="checkbox"/> STEAK CHOPPED |
| <input type="checkbox"/> COLE SLAW | <input type="checkbox"/> POTATO MASHED | <input type="checkbox"/> STEAK SALISBURY |
| <input type="checkbox"/> COMBINATION DISHES | <input type="checkbox"/> POTATO SLICED | <input type="checkbox"/> STEAK SWISS |
| <input type="checkbox"/> CORN | <input type="checkbox"/> POTATOES | <input type="checkbox"/> STEW |
| <input type="checkbox"/> DRESSING CORNBREAD | <input type="checkbox"/> POTATOES SCALLOPED | <input type="checkbox"/> STEW BEEF |
| <input type="checkbox"/> FISH BAKED | <input type="checkbox"/> POULTRY | <input type="checkbox"/> TACO MEAT |
| <input type="checkbox"/> FISH BREADED | <input type="checkbox"/> POULTRY SLICED | <input type="checkbox"/> TUNA SALAD |
| <input type="checkbox"/> GRAVY | <input type="checkbox"/> POULTRY WITH SAUCE | <input type="checkbox"/> TURKEY BREAST |
| <input type="checkbox"/> GRITS | <input type="checkbox"/> PRE PLATES | <input type="checkbox"/> TURKEY ROAST |
| <input type="checkbox"/> HAM | <input type="checkbox"/> RICE | <input type="checkbox"/> VEAL CHOPS |
| <input type="checkbox"/> JELLO | <input type="checkbox"/> ROAST WHOLE | <input type="checkbox"/> VEGETABLES |

NOTE: A list of the products can be printed by holding the button by MAIN MENU then pressing BY PRODUCT.

VII. OPERATING THE BLAST CHILL CONTROL - HOLD MODE & DEFROST

VII. e - REFRIGERATED HOLD MODE:

At the completion of a chill cycle, regardless of the mode used, the Traulsen blast chiller reverts to normal refrigerated holding mode of 37°F. Hold mode can also be manually selected at any time (i.e. interrupting the chill cycle) by using the HOLD MODE feature. When in the holding mode both the maintenance and blast chill compressors will operate during cooling portions of the cycle.

The main menu should be displayed on the control. To initiate a HOLD MODE follow the below instructions:

STEP ONE: From the MAIN MENU, select MORE by pressing the button to the right of where this is shown on the display. The menu shown will then change to display additional menu options.

STEP TWO: Press the button to the left of where HOLD PROD (hold product) is shown on the display.

HOLDING will show on the display. The timer will indicate run time in the lower left corner of the display: Hr: Min: Sec: (hours:minutes:seconds).

NOTE: HOLD mode does not retain temperature vs. time data in memory; as a result printed reports are not available.

```

MAIN MENU    AIR 35°F
◀BY TEMP    BY PROD▶
◀BY TIME
08:05:01    MORE▶
    
```

Main Menu Display

```

MAIN MENU    AIR 35°F
◀BY TEMP    BY PROD▶
◀BY TIME
08:05:01    MORE▶
    
```

```

HOLDING      AIR: 34°F
 1 37°F      37°F 3
 2 37°F
0:00:04      EXIT▶
    
```

VII. f - DEFROST:

When not in a chill cycle, the Traulsen blast chiller will automatically start a defrost cycle every three hours while in refrigerated HOLD mode. However, a defrost can also be manually initiated by following the below procedure.

STEP ONE: From the MAIN MENU, select MORE by pressing the button to the right of where this is shown on the display. The menu shown will then change to display additional menu options.

STEP TWO: Press the button to the left of where DEFROST is shown on the display. The menu will then change slightly to show REMOVE FOOD, CANCEL and START.

NOTE: Remove food from the blast chiller before proceeding.

STEP THREE: Press the button to the right of where START is shown on the display to initiate a manual defrost cycle. The defrost cycle will run for 40 minutes or until both the maintenance and blast chill coil temperatures reach 50°F. Once initiated, the defrost cycle will only terminate on time or temperature, and cannot be manually terminated.

For model RBC100, a common evaporator coil is used for the both the blast chill and maintenance compressors.

```

MAIN MENU    AIR 35°F
◀BY TEMP    BY PROD▶
◀BY TIME
08:05:01    MORE▶
    
```

Main Menu Display

```

MAIN MENU    AIR 35°F
◀BY TEMP    BY PROD▶
◀BY TIME
08:05:01    MORE▶
    
```

```

MAIN MENU    08:06:01
◀HOLD PROD  PRINT▶
◀DEFROST    SETUP▶
◀BACK
    
```

```

READY TO DEFROST
REQUIRED IN XX MIN.
      REMOVE FOOD
◀ CANCEL    START▶
    
```

XX = Number of minutes until next scheduled defrost.

```

DEFROSTING
      MAINT  50°F
      BLAST  49°F
00:10:05
    
```

VII. OPERATING THE BLAST CHILL CONTROL - PRINTING

VII. g - PRINTING BATCH/CHILL CYCLE DATA:

Once a chill cycle is complete, data can be printed.

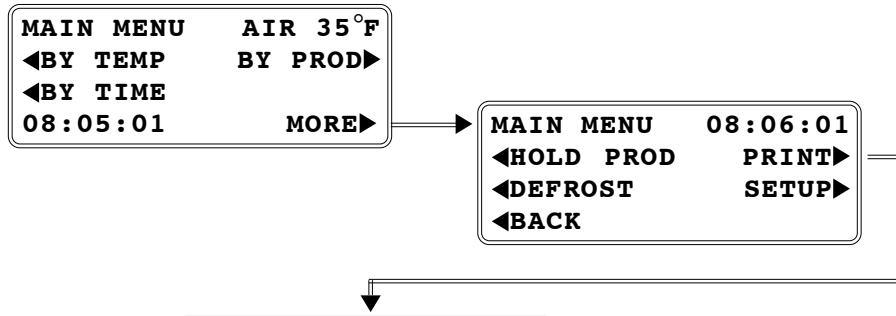

Press to select DATA.
 Press to change to a previous date.
 For multi-batching, press to select probe.
 Press to return to MAIN MENU.

PRINT: CYCLE
 ← 4/03 08:40 →
 ◀PRB#1 RECORD▶
 ◀MAIN MENU PRINT▶

Press to change to a future date.
 Press to select LABEL or BOTH.
 Press to print selection.

However, the following information can always be printed.

Press to select LIST.
 Press to change to a previous date.
 Press to return to MAIN MENU.

PRINT: DATA
 ← 4/03 08:00 →
 12 HOUR LOG ▶
 ◀MAIN MENU PRINT▶

Press to change to a future date.
 Press to print selection.

Standard On-Board Printer Sample

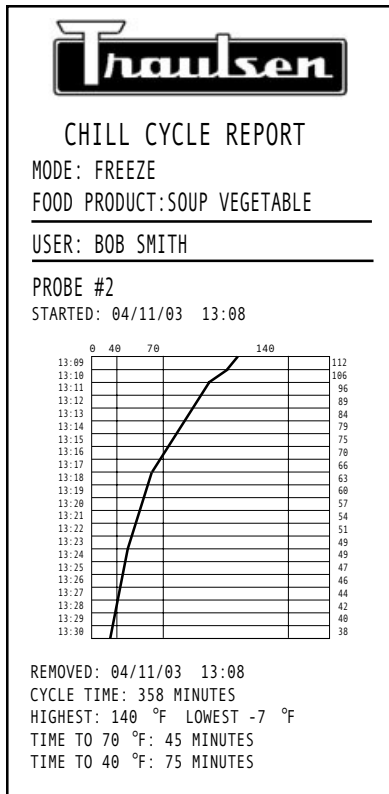

Optional Label Printer Sample

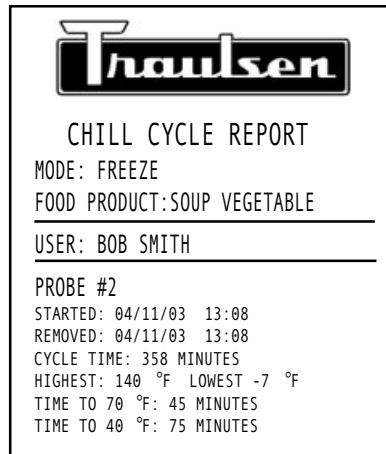

NOTE:
 When printing at the end of a BY TEMP cycle, the controller will print an abbreviated Chill Cycle Report. Only the data from when the cycle started until the desired target temperature was reached will be printed. If for any reason after reaching the set temperature the temperature increased above 40F during the HOLD cycle, that information will be printed at the bottom of the Chill Cycle Report,

VII. OPERATING THE BLAST CHILL CONTROL - SET UP PRODUCTS

VII. h- SET-UP PRODUCTS:

Pages 15 and 16 describe the chill BY PRODUCT mode, where the operator can choose from a preprogrammed list of product chill parameters. As shipped from the factory, only two products on the list are enabled and ready from immediate use (chicken parts and vegetable soup). To enable any of the other food products which appear on the list please follow the below procedure.

STEP ONE: From the MAIN MENU, select MORE by pressing the button to the right of where this is shown on the display. The menu shown will then change to display additional menu options.

STEP TWO: Press the button to the right of where SETUP is shown on the display. Note when you first enter SETUP, only Preset Supervisor is available. On the PASSWORD (PIN) line, use the UP or DOWN keys until 57 is displayed as the Preset Supervisor's Personal Identification Number. Press ENTER. The menu shown will then change back to display the SETUP menu options.

If users have already been setup, select the supervisor's name using the UP or DOWN keys. On the next line, use the UP or DOWN keys to enter their Password (or Personal Identification Number). Press ENTER. The menu shown will then change back to display the SETUP menu options.

STEP THREE: Press the button to the left of where PRODUCTS is shown on the display.

STEP FOUR: Press the button to the left of where ENABLE / DISABLE is shown on the display to choose what products are enabled on the product list (only an enabled product is available to chill BY PRODUCT).

STEP FIVE: Press the button to the right of where BACK is shown on the display in order to save the revised BY PRODUCT listing.

NOTE: If it is necessary to edit the settings (BY TEMPERATURE or BY TIME and their associated endpoints) please proceed by using the below procedure.

STEP ONE: Select ENABLE / DISABLE to choose what products are enabled from the Product List. Only an enabled product is available to chill BY PRODUCT.

STEP TWO: Select EDIT SETTINGS to adjust chill parameters for any product that has already been enabled (BACK returns to SETUP).

STEP THREE: After selecting ENABLE / DISABLE, use the UP or DOWN keys to select a product from the list. Press ◀ to change ENABLED: NO to YES to enable the product or to change YES to NO to disable it. The two most recently chilled products cannot be disabled. BACK saves the 'enabled' and returns to SETUP PRODUCTS.

STEP FOUR: After selecting EDIT SETTINGS, use the UP or DOWN keys to select a product. Finish all the below steps to change any setting(s).

- Select the Type: CHILL, SOFT CHILL or FREEZE.
- Select BY TEMP or BY TIME. Use the ↓ or ↑ keys to adjust the TARGET TEMP if BY TEMP is displayed, or to adjust the CYCLE TIME if BY TIME is displayed.
- Select MORE and use the ↓ or ↑ keys to adjust the HOLD TEMP.
- Press SAVE to keep the changes and return to SETUP PRODUCTS. (CANCEL returns to SETUP PRODUCTS without saving the changes. BACK returns to the previous screen).

```

MAIN MENU    AIR 35°F
◀BY TEMP    BY PROD▶
◀BY TIME
08:05:01
    
```

```

MAIN MENU    AIR 35°F
◀BY TEMP    BY PROD▶
◀BY TIME
08:05:01    MORE▶
    
```

```

MAIN MENU    08:06:01
◀HOLD PROD  PRINT▶
◀DEFROST    SETUP▶
◀BACK
    
```

```

SELECT SUPERVISOR:
↓PRESET SUPERVISOR↑
↓PASSWORD (PIN): 00↑
◀CANCEL      ENTER▶
    
```

```

SELECT SUPERVISOR:
↓TIM SMITH      ↑
↓PASSWORD (PIN): 57↑
◀CANCEL      ENTER▶
    
```

```

SETUP        09:04:11
◀PRODUCTS   SYS PAR▶
◀USERS
◀MAIN MENU
    
```

```

SETUP PRODUCTS:
◀ENABLE/DISABLE
◀EDIT SETTINGS
BACK▶
    
```

```

PRODUCT SELECTION:
↓ASPAGUS      ↑
◀ENABLED: NO
◀EDIT      BACK▶
    
```

```

SETUP PRODUCTS:
◀EDIT SETTINGS
BACK▶
    
```

```

↓ASPAGUS      ↑
◀TYPE: CHILL
↓TARGET TEMP: 37°F↑
◀BY TEMP      MORE▶
    
```

```

↓ASPAGUS      ↑
↓HOLD TEMP:   37°F↑
                                CANCEL▶
◀BACK      SAVE▶
    
```

```

↓ASPAGUS      ↑
↓HOLD TEMP:   37°F↑
                                CANCEL▶
◀BACK      SAVE▶
    
```

VII. OPERATING THE BLAST CHILL CONTROL - SET UP USERS

VII. h - SET-UP USERS:

The SmartChill® control offers the convenience of having individual operators have their own unique BY PRODUCT and SYSPAR settings already programmed, facilitating the changing chilling needs of different production shifts. To add new user settings please follow the below procedure.

STEP ONE: From the MAIN MENU, select MORE by pressing the button to the right of where this is shown on the display. The menu shown will then change to display additional menu options.

STEP TWO: Press the button to the right of where SETUP is shown on the display. Note when you first enter SETUP, only Preset Supervisor is available. On the PASSWORD (PIN) line, use the UP or DOWN keys until 57 is displayed as the Preset Supervisor's Personal Identification Number. Press ENTER. The menu shown will then change back to display the SETUP menu options.

If users have already been setup, select the supervisor's name using the UP or DOWN keys. On the next line, use the UP or DOWN keys to enter their Password (or Personal Identification Number). Press ENTER. The menu shown will then change back to display the SETUP menu options.

STEP THREE: Press the button to the left of where USERS is shown on the display.

STEP FOUR: Press the button to the left of where ADD is shown on the display to add new users to the roster.

NOTE: The first user entered is automatically given Supervisor access. This can be changed by using the EDIT/DELETE selection to change a given user's security level or PIN number, or delete an entire user from the roster. DELETE ALL removes all users from the roster.

STEP FIVE: To enter the name of a new user, press the buttons to the left and right of the UP and DOWN arrows to scroll through the alphabet, one character at a time. Press the button to the right of where NEXT is shown on the display to set this character and move on to the next letter, repeating this until the new users name is complete.

NOTE: BACK moves the cursor one space to the left to allow for editing. Press the button to the right of where ENTER is shown on the display to save the new users name (CANCEL aborts this process).

STEP SIX: Select the new users security level by pressing the button to the right of where SECURITY LEVEL is shown on the display (pressing this button toggles between OPER (operator level) and SUPV (supervisor). Please note that at least one user must already be set-up as a supervisor before an operator access level can be selected.

STEP SEVEN: To enter the new user's two-digit PASSWORD, press the buttons to the left and right of the UP and DOWN arrows to scroll through the numbers 00-99. Press the button to the right of where ENTER is shown on the display to set this users access level and pin number. The display will return to the SET-UP USERS menu. Press the button to the right of where BACK is shown on the display to return to the SETUP menu. Press the button to the left of where MAIN is shown on the display to return to the main menu.

```

MAIN MENU    AIR 35°F
◀BY TEMP    BY PROD▶
◀BY TIME
08:05:01
    
```

```

MAIN MENU    AIR 35°F
◀BY TEMP    BY PROD▶
◀BY TIME
08:05:01    MORE▶
    
```

```

MAIN MENU    08:06:01
◀HOLD PROD  PRINT▶
◀DEFROST    SETUP▶
◀BACK
    
```

```

SETUP        09:04:11
◀PRODUCTS  SYS PAR▶
◀USERS
◀MAIN MENU
    
```

```

SETUP USERS:
◀ADD        DELETE ALL▶
◀EDIT/DELETE
                BACK▶
    
```

```

SELECT SUPERVISOR:
↓TIM SMITH  ↑
↓PASSWORD (PIN): 07↑
◀CANCEL    ENTER▶
    
```

```

ENTER NAME:
↓_          ↑
◀BACK      NEXT▶
◀CANCEL    ENTER▶
    
```

```

ENTER NAME:
↓TIM SMITH  ↑
◀BACK      NEXT▶
◀CANCEL    ENTER▶
    
```

```

SETUP USER:
SECURITY LEVEL: OPER
↓PASSWORD (PIN): 00↑
                ENTER▶
    
```

```

SETUP USER:
SECURITY LEVEL: OPER▶
↓PASSWORD (PIN): 23↑
                ENTER▶
    
```

```

SETUP USER:
SECURITY LEVEL: OPER▶
↓PASSWORD (PIN): 23↑
                ENTER▶
    
```

VII. OPERATING THE BLAST CHILL CONTROL - SYSPAR

VII. i - ACCESSING SYS PAR SETTING LEVEL:

SYS PAR represents the supervisor level of access to the SmartChill® controller, allowing on-site adjustment to the factory preset operating parameters.

To enter the SYSPAR access level please follow the below procedure.

STEP ONE: From the MAIN MENU, select MORE by pressing the button to the right of where this is shown on the display. The menu shown will then change to display additional menu options.

STEP TWO: Press the button to the right of where SETUP is shown on the display. Note when you first enter SETUP, only Preset Supervisor is available (as delivered, only the factory preset supervisor's PIN access or ID is set-up).

Press the buttons to the left and right of where PASSWORD is shown on the display to scroll to the factory preset PIN of "57." Press the button to the right of where ENTER appears on the control to enter this PIN number. The SETUP display menu is displayed.

NOTE: If users have already been setup, select the supervisor's name using the UP or DOWN keys. On the next line, use the UP or DOWN keys to enter their Password (or Personal Identification Number). Press the button to the right of where ENTER appears on the control to enter this selection. The SETUP display menu is displayed.

STEP THREE: From the SETUP display menu, select the button to the right of where SYS PAR is shown on the display. Refer to the diagram on page 21 in order to access the various Sys Par settings

```

MAIN MENU    AIR 35°F
◀BY TEMP    BY PROD▶
◀BY TIME
08:05:01    MORE▶
    
```

```

MAIN MENU    08:06:01
◀HOLD PROD  PRINT▶
◀DEFROST    SETUP▶
◀BACK
    
```

```

SELECT SUPERVISOR:
↓PRESET SUPERVISOR↑
↓PASSWORD (PIN): 00↑
◀CANCEL    ENTER▶
    
```

```

SELECT SUPERVISOR:
↓PRESET SUPERVISOR↑
↓PASSWORD (PIN): 57↑
◀CANCEL    ENTER▶
    
```

```

MAIN MENU    08:06:01
◀HOLD PROD  PRINT▶
◀DEFROST    SETUP▶
◀BACK
    
```

```

SETUP        09:04:11
◀PRODUCTS  SYS PAR▶
◀USERS
◀MAIN MENU
    
```

```

SYS PAR:    SET CLOCK▶
◀ITEM:      MONTH▶
▼VALUE:APRIL ▲
◀CANCEL    ENTER▶
    
```

SYS PAR Menu Display

VII. OPERATING THE BLAST CHILL CONTROL - SYSPAR

VII. j - SYSPAR - SETTING THE VARIOUS CONTROL FEATURES:

By accessing SYSPAR (system parameters), the operator can adjust many control features to better suit their operational needs, such as: Clock Settings, Probes, Temperature Scale (F or C), Alarm Settings and Chill Parameters. It also provides for an easy return to the original factory default settings with a RESET feature.

From the SETUP screen, select SYS PAR to get:

Press to select SYS PAR.

Press to decrease ITEM.

Press to decrease VALUE.

Press to return to MAIN MENU*

*without saving.

```

SYS PAR:  SET CLOCK▶
◀ITEM:MONTH
▼VALUE:APRIL      ▲
◀CANCEL          ENTER▶
    
```

SYS PAR Menu Display

Press to select SYS PAR.

Press to increase ITEM.

Press to increase VALUE.

Press to return to SETUP with saving.

1) SET CLOCK

- a) MONTH (JANUARY – DECEMBER)
- b) DATE (1 – 31¹)
- c) YEAR (2003 – 2079)
- d) DAY OF WEEK (SUNDAY – SATURDAY)
- e) HOUR (0 – 23)
- f) MINUTE (0 – 59)
- g) DLS TIME (ENABLED – DISABLED)

2) PROBES

- a) 1 (ON – OFF) b) 2 (ON – OFF)
- c) 3 (ON – OFF)

3) DISPLAY

- a) TEMPERATURES (IN DEG C – IN DEG F)

4) LOGGING

- a) TIME (5-MINUTES – 30-MINUTES)

5) ALARM

- a) CYCLE RUNNING (NO – yes)
- b) CYCLE ENDS (NO – yes)
- c) PRINTER ERROR (NO – yes)
- d) HIGH/LOW TEMP (no – YES)
- e) POWER FAILURE (no – YES)

6) REMINDERS

- a) DOOR OPEN (0 – 2 MINUTES)

7) BLAST

- a) TARGET (33 – 40) b) AIR (10 – 40)
- c) HOLD (10 – 40) d) HIGH ALARM (35 – 60)
- e) LOW ALARM (-30 – 34)

8) SOFT CHILL

- a) BY TEMP (5 – 20) b) BY TIME (10 – 90)
- c) 2ND TEMP (10 – 40)

9) FREEZE CHILL

- a) TARGET (-22 – 28) b) AIR (-32 – 20)
- c) HOLD (10 – 40) d) HIGH ALARM (20 – 45)
- e) LOW ALARM (-30 – 0)

10) RESET

- a) PARAMETERS (YES – NO)

```

SYS PAR:  SET CLOCK▶
◀ITEM:MONTH
▼VALUE:APRIL      ▲
◀CANCEL          ENTER▶
    
```

```

SYS PAR:  SET CLOCK▶
◀ITEM:DATE
▼VALUE:04/XX/00   ▲
◀CANCEL          ENTER▶
    
```

```

SYS PAR:  SET CLOCK▶
◀ITEM:YEAR
▼VALUE:04/14/XX   ▲
◀CANCEL          ENTER▶
    
```

```

SYS PAR:  SET CLOCK▶
◀ITEM:HOURL
▼VALUE:XX:00      ▲
◀CANCEL          ENTER▶
    
```

```

SYS PAR:  SET CLOCK▶
◀ITEM:MINUTE
▼VALUE:10:XX      ▲
◀CANCEL          ENTER▶
    
```

¹ Last day is corrected for month and leap year.

VIII. SMARTCHILL™ COMMUNICATIONS

VIII. a - INTRODUCTION:

All Traulsen SmartChill® equipped blast chiller models are supplied from the factory capable of on-line communications. However, an optional software/hardware kit is required to make this compatible with your PC. Use of this provides many user advantages, such as:

- Retrieving Batch/Chill Cycle Data
- Viewing Users and Their Status
- Exporting Data To A Spreadsheet
- Adding Additional Products To The BY PRODUCT Mode

VIII. b - SYSTEM REQUIREMENTS:

IBM PC, Pentium II 300mhz or greater, Windows 95, 98, 2000, ME or NT operating system, 10 x CD ROM Drive, 64 MB RAM, 800 x 600 display, 24 bit color support.

VIII. c - OPERATION:

For more information and operation detail, please refer to the SmartChill® Communications User's Guide, form number TR35853.

VIII. d - COMMUNICATION WITH SMARTCHILL®:

During communication with the SmartChill® program on a PC, the screen below displays.

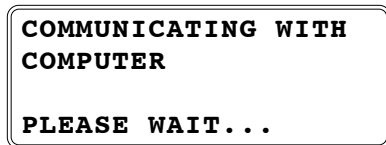

VIII. e - HARDWARE CONNECTION:

To utilize the communication features of the SmartChill® control, it is necessary to connect this to a PC using its RS232 data port. See form number TR35853 for more information.

IX. GLOSSARY

Alarms: Sets buzzer intervals after Door is Open or when to be notified that the Compressor needs to be Cleaned.

By Temp: Chill cycle that terminates when the probes reach the Target Temperature.

By Time: Chill cycle that terminates after a set amount of time has lapsed.

By Prod: Chill cycle that terminates after a particular product's specified chill parameters are met (the parameters can be set either By Temp or By Time with specific cut-offs for a particular product).

Chill: Chilling Cycle that may end with either Time or Temperature controlled events. (Also see Soft Chill or Freeze).

Clock: Allows the Date and Time to be entered so the system's clock correctly records chilling events.

Cycle #: The system assigns a consecutive number to each Chill Cycle.

Defrost: System Controlled Defrost occurs after three hours of chilling (this can also be set to occur at between 2 - 6 hours). The defrost will not begin during a chill cycle. The system waits until it is in Holding mode before starting the defrost cycle. The Defrost from the Main Menu is a manual defrost that will not run if selected and unneeded. The Defrost cycle requires about 30 minutes (this can also be set from 20 - 60 minutes in duration as needed).

Fac Presets: Factory Presets are system parameters that are set at the factory but can be changed by the supervisor.

Freeze: This mode allows the product to be frozen down to a target temperature. The target temperature range available for freeze mode varies from -22°F to 28°F.

Hold Prod: After completed chill cycle or when selected from the Main Menu, the chiller will act like a regular refrigerator.

Label: A condensed Chill Cycle Report that can be printed on adhesive-backed label stock by the label printer.

Logging: The time interval at which Chill Cycle data (temperature vs. time) is logged into memory for record purposes. The factory setting is 5 minutes.

Main Menu: The two initial menus available from the controller after the chiller is turned on.

Mode: Basic chiller operating parameters are available from Sys Par in Setup mode.

Chill mode parameters allow adjustment of the target temperature, the air temperature during chill mode, the hold mode temperature, the high alarm temperature, the low alarm temperature and the maximum chill mode target temperature. Soft Chill mode parameters apply a modification of some of the Chill settings during the final portion of the chill cycle if Soft Chill is selected. Soft Chill provides additional protection against freezing of surfaces.

Oper: An Operator is a user who is allowed to operate the chiller and make reports of chill cycles performed.

Print: Allows a report of any Chill Cycle and probe to be printed. Chillers equipped with the optional second printer can print the condensed 'Label' type of report. All Chillers can print the 'Record' type of report.

Probe #: Each probe is numbered and its temperature vs. time is recorded for each probe # during every BY TEMP chill cycle and the record can be printed, either at the end of the chill cycle or subsequently.

Product List: A list of products in system memory which can have individual chill parameters specifically set for each product (assuming that the product is already enabled). Refer to Setup Products.

Record: Type of report that can be printed by all chillers. This report provides a record of time vs. temperature for a specific Probe and Chill Cycle.

Remote Alarm: The chiller can be wired to a remote alarm which will close the remote alarm circuit in the event of one or more of the following situations: Printer Error, Cycle End, Door Open, High or Low Temperatures or Power Failure. If Cycle Running is chosen, the remote alarm circuit will close when a chill cycle is running and all other remote alarm settings are overridden (reset to NO). The supervisor can determine which events the remote alarm will signal by adjusting the settings in the Sys Par (System Parameters) section.

Setup: Specific control settings that can be set by the supervisor which determine how the chiller will operate.

Soft Chill: Type of chill process that moderates the temperatures and fan speed near the end of the chill cycle to provide less risk of freezing at the product's surface.

Supv: A Supervisor is a user who is allowed to identify the users and limit their access to system parameters, enable products to be selected, set specific product chill parameters and change system parameters.

Sys Par: System Parameters are control settings that determine how the chiller will operate. These settings can be adjusted by the supervisor in Setup mode.

Temps in °C: If so displayed on the Sys Par 1 screen, all temperatures will be recorded in °C (Celsius).

Temps in °F: If so displayed on the Sys Par 1 screen, all temperatures will be recorded in °F (Fahrenheit).

X. REPLACEMENT PARTS LIST

<u>MODEL NUMBER</u>	<u>PART/DESCRIPTION</u>	<u>PART #</u>
RBC50	CORDSET - 115V	333-13013-01
RBC50	POWER PACK ASSEMBLY	900-60233-00
RBC50/RBC100	6" HIGH STAINLESS STEEL LEGS	344-13168-01
RBC50	STAINLESS STEEL SIDE PANEL	401-60027-01
RBC50	UNIVERSAL TRAY SLIDE	701-60115-00
RBC100	LOUVER ASSEMBLY	500-60154-00
RBC100	DRAINPAN	701-60105-00
RBC100	PROBE CABLE HOOK	344-60081-00
ALL MODELS	HINGE BODY	344-28482-00
ALL MODELS	HINGE COVER	344-28486-00
ALL MODELS	HINGE CAM	344-28488-00
ALL MODELS	HINGE BRACKET	344-28487-00
RBC100	HORIZONTAL BREAKER CAP	345-60011-04
RBC100	VERTICAL BREAKER CAP	345-60011-05
RBC100/200/400	LOCK KEEPER	346-60018-00
RBC100/200/400	LOCK KEEPER BRACKET	346-60019-00
RBC100/200/400	SMARTCHILL® CONTROL KIT	SER-60461-00
RBC100	DOOR - HINGED RIGHT	200-60059-00
RBC100	TRAY SLIDE	342-60014-00
RBC100	PRINTER COVER	701-60741-00
ALL MODELS	STANDARD PRINTER PAPER	400-60003-00
ALL MODELS	LABEL PAPER	400-60004-00
ALL MODELS	SMART PROBE	333-60331-00
RBC200/200RT	LOUVER ASSEMBLY	500-60138-00
RBC200/200RT	ROLL-IN RAMP	501-60409-00
RBC200/200RT	RECORD/LABEL PRINTER	950-60355-00
RBC200/200RT	PRINTER COVER	701-60724-01
RBC200/200RT	DOOR - HINGED LEFT	200-36064-00
RBC400/400RT	LOUVER ASSEMBLY	500-60138-00
RBC400/400RT	ROLL-IN RAMP	501-60409-00
RBC400/400RT	RECORD/LABEL PRINTER	950-60355-00
RBC400/400RT	PRINTER COVER	701-60724-01
RBC400/400RT	DOOR - HINGED LEFT	200-36064-00

XI. SUMMARY OF ERROR MESSAGES

SYSTEM/CONTROL ERROR
CURRENT PROBE IS BAD
CHECK FOOD PROBES
PLUGGED IN EXIT▶

CHILLING AIR: 10°F
 41°F 3
2 37°F
 STOP/RESET▶

FAILED PROBE (#1)

SYSTEM/CONTROL ERROR
CHILL TIME EXCEEDED
CONTACT SERVICE!
 EXIT▶

SYSTEM/CONTROL ERROR
DEFROST FAILURE
CONTACT SERVICE!
 EXIT▶

SYSTEM/CONTROL ERROR
NO PRODUCT PROBES
CHECK FOOD PROBES
USE BY TIME EXIT▶

SYSTEM/CONTROL ERROR
OVER TEMPERATURE
CONTACT SERVICE!
TURN OFF/UNPLUG UNIT

PRODUCT DETECTED!
STARTING HOLD MODE
CHECK FOOD PROBES
 EXIT▶

AIR TEMP SENSOR
NOT READING
CONTACT SERVICE
TURN OFF/UNPLUG UNIT

XI. a - FOOD PROBE ERROR DURING CHILL CYCLE BY TEMP:

In the event of a food probe error during a BY TEMP chill cycle, the control automatically switches to a BY TIME chill cycle. The timer will begin to countdown from 90 minutes, at which time the chill cycle will be complete.

XI. b - FOOD PROBE ERROR DURING CHILL CYCLE BY TIME:

In the event of a food probe error during a BY TIME chill cycle, or during a refrigerated holding cycle, the control will no longer display a temperature for that probe.

XI. c - CHILL TIME EXCEEDED:

In the event a chill cycle does not complete within six hours, the control automatically switches operation to a refrigerated holding cycle. This cycle will continue until the operate selects EXIT and returns to the main menu to choose another cycle option.

XI. d - DEFROST FAILURE:

Occurs when either a coil probe temperature falls below 25°F after a defrost cycle, or in the event of a probe short circuit. Unit automatically switches to IDLE mode.

XI. e - NO PRODUCT PROBES:

Occurs when either a BY TEMP or BY PRODUCT chill cycle has been attempted, but no food probes are connected. Unit automatically switches to IDLE mode.

XI. f - OVER TEMPERATURE:

Occurs when cabinet air temperature rises above 160°F. Unit automatically turns off all compressors, fans and defrost heaters. NOTE: To reset control after an OVER TEMPERATURE alarm it is necessary to either turn OFF or unplug the unit.

XI. g - PRODUCT DETECTED W/O CYCLE STARTED:

Occurs when cabinet air temperature rises above 40F for ten minutes (with product in the unit but no chill cycle started). Unit automatically switches to a refrigerated holding cycle.

XI. h - CABINET AIR TEMPERATURE SENSOR:

Occurs when the cabinet air sensor has shorted or is open. Unit automatically turns off compressors, fans and defrost heaters.

NOTE: To reset the control after an air temperature sensor failure, it is necessary to turn off or unplug the unit and replace the faulty air temperature sensor.

XII. WARRANTY INFORMATION

STANDARD DOMESTIC WARRANTY

TRAULSEN warrants new equipment to the original purchaser, when installed within the United States against defective material and workmanship for one (1) year from the date of original installation. Under this warranty, TRAUlsen will repair or replace, at its option, including service and labor, all parts found to be defective and subject to this warranty. The compressor part (self-contained only) is warranted for an additional four (4) years. During this period TRAUlsen will supply replacement compressor(s) if deemed defective, however, all installation, recharging and repair costs will remain the responsibility of the owner.

This warranty does not apply to damage resulting from fire, water, burglary, accident, abuse, misuse, transit, acts of God, terrorism, attempted repairs, improper installation by unauthorized persons, and will not apply to food loss.

The remote compressor used on models RBC200 and RBC200RT, when purchased from Traulsen, is warranted for a period of five (5) years from the date of original installation. During this period TRAUlsen will supply replacement compressor if deemed defective, however, after the first year, all installation, recharging and repair costs will remain the responsibility of the owner.

THERE ARE NO ORAL, STATUTORY OR IMPLIED WARRANTIES APPLICABLE TO TRAUlsen, INCLUDING BUT NOT LIMITED TO, ANY IMPLIED WARRANTY OF MERCHANTABILITY OR FITNESS FOR ANY PARTICULAR PURPOSE WHICH EXTEND BEYOND THE DESCRIPTION ON THE FACE HEREOF. TRAUlsen SHALL HAVE NO OBLIGATION OR LIABILITY FOR CONSEQUENTIAL OR SPECIAL DAMAGES, GROWING OUT OF OR WITH RESPECT TO THE EQUIPMENT OR ITS SALE, OPERATION OR USE, AND TRAUlsen NEITHER ASSUMES NOR AUTHORIZES ANYONE ELSE TO ASSUME FOR IT ANY OBLIGATION OR LIABILITY IN CONNECTION WITH THE EQUIPMENT OR ITS SALE, OPERATION OR USE OTHER THAN AS STATED HEREIN.

INTERNATIONAL COMMERCIAL WARRANTY

(for Canadian warranties see domestic US warranty)

TRAULSEN warrants to the original purchaser the Refrigeration Equipment manufactured and sold by it to be free from defects in material and workmanship under normal use and service for a period of one (1) year from date of shipment. Under this warranty, **TRAULSEN** will reimburse the purchaser for the replacement of any part of said equipment (excluding dryers & refrigerant gas) which then proves to be defective. **This warranty does not apply to damage resulting from fire, water, burglary, accident, abuse, misuse, transit, acts of God, terrorism, attempted repairs, improper installation by unauthorized persons, and will not apply to food loss.**

TRAULSEN'S standard warranty does not apply to Export Sales. Rather, for a period of one (1) year from date of original installation not to exceed Fifteen (15) months from date of shipment from factory, TRAUlsen:

will replace, F.O.B. factory, any defective parts normally subject to warranty.

will not cover the cost of packing, freight or labor such costs being the sole responsibility of the dealer.

THIS WARRANTY IS IN LIEU OF ALL OTHER WARRANTIES EITHER EXPRESSED OR IMPLIED AND CONSTITUTES TRAUlsen'S FULL OBLIGATION AND LIABILITY. WARRANTIES NOT AVAILABLE ON REMOTE MODELS.

XIII. MECHANICAL TROUBLE SHOOTING GUIDE

<p>1. Condensing unit fails to start when programming a new batch.</p>	<p>a. Check power supply to condensing unit. b. Batch was not programmed properly. Select chill method, press START, and if required select probes. c. System problem. Call for service.</p>
<p>2. Batch requires too much time to chill product down to 40° F. Chill Cycle Batch Over 6-Hours will ALARM and a printout will note the chill cycle has exceeded maximum safe time.</p>	<p>a. Is the door closed properly? If not, close door completely. b. Too much product loaded. Adjust the load to not exceed capacity of the unit. c. Product depth in pan exceeds 2". Reduce pan load per guidelines on page 7. d. Has pan been covered with a lid, plastic wrap or foil, and is this not in direct contact with the product? Cover product correctly as per guidelines on page 7. e. Perhaps the product loaded is of a high density. Allow additional chilling time. f. Dirty condenser coil. Clean condenser as per instructions on page 6. g. Evaporator coil iced. Allow to defrost (press DEFROST to initiate a manual defrost).</p>
<p>3. Food Probe Failure - ALARM will occur during a chill cycle batch with printout noting the Food Probe Failure Warning.</p>	<p>a. Food Probe Failure - printer will notify the operator that it is converting to chilling BY TIME. b. When starting a BY TEMP cycle, if food probe is not available, there is an open circuit. Check the probe plug connection. c. Food probe was placed in excessively hot product. Product temperatures exceeding 210° F can result in the probe reporting false temperatures. Cool food probe and test again. d. Food probe fails and will then operate correctly at a later time. Program a BY TEMP batch using the suspect probe. Wiggle the food probe wire. If a second Food Probe Failure occurs the food probe is defective. Replace with new food probe. g. Damaged or defective food probe. Replace with new food probe.</p>
<p>4. Refrigeration Failure - ALARM with a printout noting the warning will occur when the interior temperature exceeds 100° F for more than 20-minutes. Blast Chill refrigeration system will shut down as a safety default. The compressors and blower fans are shut off and the control key pad is locked out.</p>	<p>Refrigeration Failure CORRECTION - Remove power from the unit. Unplug and then replug the unit or reset the circuit breaker (OFF and back ON). The Blast Chiller will reset and turn ON. Power Loss Failure will printout when reset.</p> <p>a. Batch programming was incomplete or incorrect and chill cycle did not start. Try programming batch again. b. Too much product loaded. Adjust the load to not exceed capacity of the unit. c. Dirty condenser coil. Clean condenser as per instructions on page 6. d. Refrigeration system failure, unit will not cool after having been reset. Call service for repair.</p>
<p>5. Power Loss Notification - Printout notes the time power was lost and the time in which it was restored.</p>	<p>a. Power was lost to the Blast Chill unit. If product was inside the unit see the printout to determine if product temperature was compromised. The printout will show the temperature before and after the interruption.</p>
<p>6. Cannot program a new batch.</p>	<p>a. Unit may be in a defrost cycle. Batch programming cannot be done while in a defrost cycle. b. If during a BY TEMP chill cycle, a new batch can be added by using the ADD/REMOVE option.</p>
<p>7. Printer not printing.</p>	<p>a. Printer is out of paper. Replace printer paper roll as per instructions on page 6. b. Printer paper may be installed incorrectly. Verify that the thermal sensitive side of the paper is on the top and feed door closed, see instructions on page 6 or label in the printer cavity. c. Paper does not feed or jams behind the paper feed slot in the cover. Remove paper and reinstall as per instructions on page 6 or label in the printer cavity.</p>
<p>8. No display on control.</p>	<p>a. Check power supply and circuit breaker. b. Confirm unit is correctly plugged into a working power outlet. c. System problem. Call for service.</p>
<p>9. Condensation on exterior surface.</p>	<p>Condensation on the exterior surface of the unit is perfectly normal during periods of high humidity, otherwise refer below for other possible causes.</p> <p>a. Check door alignment and gasket for proper seal. b. On Roll-In/Roll-Thru models, check bottom door sweep for proper adjustment. c. Electric door heater malfunction. Call for service.</p>



Quality Refrigeration

Traulsen
4401 Blue Mound Road Fort Worth, TX 76106
Phone: (800) 825-8220 Fax-Svce: (817) 740-6757
Website: www.traulsen.com

HOURS OF OPERATION:
Monday thru Friday 7:30 am - 4:30 pm CST